

## **Tender Notification for**

**SUPPLY, INSTALLATION, TESTING & COMMISSIONING OF  
33 kV EHV Lines & 11 KV/LT DISTRIBUTION NETWORK  
INCLUDING DISMANTLING ON SINGLE POINT  
RESPONSIBILITY BASIS IN CONNECTION WITH &  
SHIFTING/RELOCATION OF 11 KV & 33 KV FEEDERS AT  
SARAI KALE KHAN (NCRTC)**

**NIT NO CMC/BR/20-21/SV/RS/KG/870 DT 08.09.2020**

**Due Date for Submission: 29.09.2020 1530HRS**

### **BSES RAJDHANI POWER LTD (BRPL)**

Corporate Identification Number: **U74899DL2001PLC111527**

Telephone Number: +91 11 3009 9999

Fax Number: +91 11 2641 9833

Website: [www.bsedelhi.com](http://www.bsedelhi.com)

## Table of Contents

Section No.	Description
Section-I	Request for Quotation
Section-II	Instruction to Bidders
Section-III	Special Terms & Condition of Contracts
Section-IV	General Terms and Condition –Supply
Section-V	Price format- Supply
Section-VI	General Terms and Condition –Erection, Testing & Commissioning
Section-VII	Price format- Erection, Testing & Commissioning
Section-VIII	Grand Summary of the Quoted Price
Section-IX	Vendor Code of Conduct
Annexure-I	General
Annexure-II	Scope Demarcation and Route Map
Annexure-III	Technical Specifications

**SECTION – I: REQUEST FOR QUOTATION****1.00 Event Information**

BRPL invites sealed tenders in 2 envelopes for following scope of work

Sl. No.	Description	Part	Estimated Cost (Rs.)	Qty.	Delivery & Installation at
1	SUPPLY, INSTALLATION, TESTING & COMMISSIONING OF 33 KV EHV Lines & 11 KV/LT DISTRIBUTION NETWORK INCLUDING DISMANTLING ON SINGLE POINT RESPONSIBILITY BASIS IN CONNECTION WITH & SHIFTING /RELOCATION OF 11 KV & 33 KV FEEDERS AT SARAI KALE KHAN (NCRTC)	<p><b>A.</b> Shifting /Relocation of 33kV feeders (IP to Kilokari Bay no. 1 &amp; 3) and 33kV O/H D/C line Bay 25 &amp; 37 at Sarai Kale khan_ NCRTC</p> <p><b>B.</b> Shifting of BSES Services up to 11 kv infringing right of way for the construction of Delhi-Ghaziabad-Meerut Regional Rapid Transit System (RRTS) Corridor near Sarai Kale Khan area NCRTC</p>	6.33 Crores	As per BOQ Attached	Delhi, Sites

The bidder must qualify the requirements as specified in clause 2.0 stated below.

All envelopes shall be duly super scribed "SUPPLY, INSTALLATION, TESTING & COMMISSIONING OF 33 KV EHV Lines & 11 KV/LT DISTRIBUTION NETWORK INCLUDING DISMANTLING ON SINGLE POINT RESPONSIBILITY BASIS IN CONNECTION WITH & SHIFTING /RELOCATION OF 11 KV & 33 KV FEEDERS AT SARAI KALE KHAN (NCRTC) NIT NO CMC/BR/20-21/SV/RS/KG/870"

1.01 The schedule of specifications with detail terms & conditions can be obtained from address given below against submission of non-refundable demand draft of **Rs.1180/-** drawn in favour of BSES Rajdhani Power Ltd, payable at Delhi. The tender documents & detail terms and conditions can also be downloaded from the website "[www.bsesdelhi.com](http://www.bsesdelhi.com) --> **Tenders** --> **BSES Rajdhani Power Ltd** --> **Open Tenders**".

In case tender papers are downloaded from the above website, then the bidder has to enclose a demand draft covering the cost of bid documents.

1.02 Bids will be received up to 29/09/2020 1530 HRS at the address given at 3.01 below. Part A of the Bid shall be opened on 29/09/2020 1600 HRS.

Part B of the Bid will be opened in case of Techno-Commercially qualified Bidders and the date of opening of same shall be intimated in due course. It is the sole responsibility of the bidder to ensure that the bid documents reach this office on or before the last date.

1.02.1 BSES Rajdhani Power Ltd reserves the right to accept/reject any or all Tenders without assigning any reason thereof in the event of following

- (i) **Earnest Money Deposit (EMD)** of value **Rs 6,33,000/-** is not deposited in shape of Demand Draft/Pay Order/Banker's Cheque /Bank Guarantee drawn in favour of BSES Rajdhani Power Ltd, payable at Delhi.
- (ii) The offer does not contain prices indicating break-up towards all taxes & duties in prescribed format
- (iii) Complete Technical details are not enclosed.
- (iv) Tender is received after due date and time.
- (iv) Technical offer contains any prices
- (v) Prices are **not FIRM** and subject to Price Variation

## 2.0 **Qualification Criteria:-**

### **Technical**

The prospective bidder must qualify all of the following requirements to participate in the bidding process and bidder who meets following requirements will be considered as successful bidder and BRPL has a right to disqualify those bidders who do not meet these requirements.

- a. The Bidder must be a manufactures of 33 kV or higher grade HV power cable for past 2 years through CCV or VCV line with following
  - i. Bidder shall have true triple extrusion machine along with CCV line with dry curing and dry cooling in Nitrogen
  - ii. Cable eccentricity monitoring system during triple extrusion in CCV line. Chartered Engineer certificate should to be submitted in support of this QR.
- b. The Bidder should have supplied at least 25 KMS of cable of 33 KV or higher voltage grade cable during last 3 years from the date of technical bid opening. Documents in support of this QR to be submitted.
- c. The Bidder should have In-house testing facilities for raw material, routine and acceptance tests as per relevant IS/IEC Self-declaration & List of testing equipment to be submitted in support of this QR.
- d. In case of new vendor not registered with BRPL, factory inspection and evaluation shall be carried out to ascertain bidder's manufacturing capability and quality procedure. However, BRPL reserves right to carry out factory inspection and evaluation for any bidder prior to technical qualification evaluation.
- e. The bidder should possess valid Electrical Contractor License issued by competent statutory agency to undertake work in NCT Delhi. In case bidder is not having this license, Bidder to give the undertaking that it will be obtained by them before the start of the work at site or suitable sub-contractor having the valid license shall be engaged for works at site where copy of valid license shall be submitted to BRPL before the award of the PO.
- f. The bidder must be a manufacturer of offered Power Cables of same or higher voltage, type with similar cross section or higher and having valid Type Test Reports carried out at CPRI/ERDA only (not more than 5 years old from the date of technical bid opening).

In case type test reports are older than five (5) years from the date of bid opening, bidder shall submit the undertaking that there is "No Design Change". Type test older than ten (10) years shall not be acceptable and bid is liable for rejection.

- g. Bidder should have at least two performance/Successful completion Certificates of successful supply, laying, testing & commissioning of 33 KV or higher voltage cable on turnkey basis in the last 3 years from the date of technical bid opening from utilities/SEBs/Govt. Bodies/reputed firms for installation in distribution network. Out of these, one certificate should be more than 10 KMs of cable.

- h. Bidder need to share at least two numbers of sub-vendors (to be engaged in execution work) and their credentials (list of Project executed, T&P, Manpower details, electrical license etc.) to BRPL. Sub-vendors shall meet the qualifying criteria as listed out in QR-2 below.

Indian Subsidiaries of global companies having plant in India are also eligible to bid if the qualification requirements stated above are met independently or in combination with the parent company. Declaration from parent company needs to be submitted.

### **Financial**

- i. **Turnover:** Bidder should have Average Annual Sales Turnover of Rs 100 Crore or more in last three (3) financial years, duly certified CA certificate to be submitted.
- j. The bidder must possess valid ISO 9001:2015 certification and valid BIS License or Equivalent International License.
- k. The bidder should have qualified technical & qualified QA personnel at various stages of manufacture & testing.
- l. An undertaking (self-certificate) that the bidder has not been blacklisted/debarred by any central/state government institution including electricity boards.
- m. The bidder must have valid PAN No., GST registration nos., in addition to other statutory compliances. The bidder must submit the copy of registrations and submit an undertaking that the bidder shall comply with all the statutory compliances as per the applicable laws/rules etc. before the start of the work.

Notwithstanding anything stated above, BRPL reserves the right to assess bidder's capability to perform the contract, assess the capability and installed capacity of the Bidder for carrying out the supplies, should the circumstances warrant such assessment in the overall interest of the purchaser. BRPL also reserves the right to evaluate the bidder based on performance of past supplies/projects executed in BRPL. In this regard the decision of the purchaser is final.

### **QR-2.0: For Sub-vendors:**

- a. Sub-vendor must provide experience certificate of having successfully laid minimum 10 KM cable of rating 33 KV\_ and above in utilities/SEBs/Govt. Bodies/reputed firms for installation in distribution network\_during the last five years in Delhi/NCR area.
- b. The Sub-vendor must enclose order copies along with performance certificates/successful completion certificates in support of relevant experience. Experience credential as a joint venture / subcontract/ consortium will not be considered
- c. For Existing vendors of BRPL, performance shall be measured on earlier executed similar works/ other works and will be taken into account in technical evaluation for qualification of bids

### **Financial**

- d. **Turnover:** Sub-vendor should have Average Annual Turnover of Rs 3 Crore or more in last three (3) financial years, duly certified CA certificate to be submitted.

- e. Sub-vendor must provide proof of having solvency of an amount equal to Rs. 50 Lacs from any nationalized/ scheduled commercial bank. (Not older than 1st April 2020)
- f. Sub-vendor should have PAN No & should fulfill all statutory compliances like PF, ESI registration, GST no.
- g. Entities that have been debarred/ blacklisted in other utilities in India will not be considered; in this regard a written statement has to be provided on Sub-vendor's letter head along with other documents.
- h. Sub-vendor should have a valid Electrical License issued by Delhi Govt. for doing electrical works in Delhi region.
- i. The Sub-vendor should give an undertaking on the company's letter head that all the documents/certificates/information submitted by them against the tender are genuine

### 3.00 **Bidding and Award Process**

Bidders are requested to submit their offer strictly in line with this tender document. **NO DEVIATION IS ACCEPTABLE.** BRPL shall response to the clarifications raised by various bidders and the will be distributed to all participating bidders through website.

#### 3.01 **BID SUBMISSION**

The bidders are required to submit the bids in 2(two) parts to the following address

**Head of Department  
Contracts & Material Department  
BSES Rajdhani Power Ltd  
1<sup>st</sup> Floor, C Block  
BSES Bhawan, Nehru Place  
New Delhi 110019**

PART A: TECHNICAL **BID** comprising of following (1 original + 1 copy)

- EMD in prescribed format
- Non-refundable demand draft for Rs 1180/- in case the forms are downloaded from website
- Documentary evidence in support of qualifying criteria
- Technical Details / Filled in GTP/Type test report etc
- Qualified Manpower available & Organization Chart
- Testing Facilities
- Copies of Orders, Execution /Performance Certificate & Other Documents to support the QC as per clause 2.0
- Original Tender documents duly stamped & signed on each page as token of acceptance
- Acceptance to Commercial Terms and Conditions viz Delivery schedule/period, Payment terms, PBG etc

PART B: FINANCIAL **BID** comprising of (1 original only)

- Price strictly in the Format enclosed indicating Break up of basic price, taxes & duties, transportation etc

### 3.02 TIME SCHEDULE

The bidders should complete the following within the dates specified as under:

S. No.	Steps	Date
1	Date of sale of bid documents	08.09.2020
2	Pre-Bid meeting	15.09.2020 1430 HRS
3	Last date of Queries, if any	18.09.2020
4	Last date of receipt of bid documents	29.09.2020 1530HRS
5	Date & time of opening of tender – Part A	29.09.2020 1600HRS

This is a two part bid process. Bidders are to submit the bids in 2(two) parts

Both these parts should be furnished in separate sealed covers super scribing NIT no. DUE DATE OF SUBMISSION, with particulars as **PART-A TECHNICAL BID & COMMERCIAL TERMS & CONDITIONS** and **Part-B FINANCIAL BID** and these sealed envelopes should again be placed in another sealed cover which shall be submitted before the due date & time specified.

**Part – A:** Technical Bid should not contain any cost information whatsoever and shall be submitted within the due date.

**PART B:** This envelope will be opened after techno-commercial evaluation and only of the qualified bidders.

**REVERSE AUCTION:** Purchaser reserves the right to use **REVERSE AUCTION** through SAP-SRM as an optional tool as an integral part of the entire tendering process. All techno-commercially qualified bidders shall participate in this event

Notwithstanding anything stated above, the Purchaser reserves the right to assess bidder's capability to perform the contract, should the circumstances warrant such assessment in the overall interest of the purchaser. In this regard the decision of the purchaser is final.

In case RA is not concluded/conducted for any reasons, a "final no regret" financial bid in a sealed envelope will be called for from all qualified bidders

### **BIDS RECEIVED AFTER DUE DATE AND TIME SHALL BE LIABLE TO REJECTION**

#### 4.00 Award Decision

4.01 Purchaser intends to award the business on a lowest bid basis, so suppliers are encouraged to submit the bid competitively. The decision to place purchase order/LOI solely depends on purchaser on the cost competitiveness across multiple lots, quality, delivery and bidder's capacity, in addition to other factors that Purchaser may deem relevant.

4.02 **Splitting of Tendered Scope of works in two or more bidders:** BSES reserve the right to split the tender scope amongst techno- commercially qualified bidders. The purchaser reserves all the rights to award the contract to one or more bidders to meet the timelines of the projects /scope of work or nullify the award decision without any reason.

4.03 In the event of your bid being selected by purchaser (and / or its affiliates) and you subsequent DEFAULT

on your bid; you will be required to pay purchaser (and / or its affiliates) an amount equal to the difference in your bid and the next lowest bid on the quantity declared in NIT/RFQ.

4.04 In case any supplier is found unsatisfactory during the delivery process, the award will be cancelled and BRPL reserves the right to award other suppliers who are found fit.

#### 5.00 **Market Integrity**

We have a fair and competitive marketplace. The rules for bidders are outlined in the Terms & Conditions. Bidders must agree to these rules prior to participating. In addition to other remedies available, we reserves the right to exclude a bidder from participating in future markets due to the bidder's violation of any of the rules or obligations contained in the Terms & Condition. A bidder who violates the marketplace rules or engages in behavior that disrupts the fair execution of the marketplace shall be restricted from bidding for a length of time, depending upon the seriousness of the violation. Examples of violations include, but are not limited to:

- Failure to honor prices submitted to the marketplace.
- Breach of the terms of the published in Request for Quotation/NIT.

#### 6.00 **Confidentiality**

All information contained in this RFQ is confidential and shall not be disclosed, published or advertised in any manner without written authorization from BRPL. This includes all bidding information submitted.

All RFQ documents remain the property of BRPL and all bidders are required to return these documents to BRPL upon request.

Bidders who do not honor these confidentiality provisions will be excluded from participating in future bidding events.

#### 7.00 **Contact Information**

Technical or Commercial clarifications, if any, as regards this RFQ shall be sought in writing and sent by post/courier to following address. The same shall not be communicated through email/phone

	<b>Technical</b>	<b>Commercial</b>
<b>Contact Person</b>	Mr. Sheshadri Krishnapura(HOD-TSG)	Mr. Robin Sebastian (Head Procurement)
<b>Address</b>	BSES Rajdhani Power Ltd , 2 <sup>nd</sup> Floor, B Block, BSES Bhawan, Nehru Place, New Delhi 110019	BSES Rajdhani Power Ltd , 1 <sup>st</sup> Floor, D Block, BSES Bhawan, Nehru Place, New Delhi 110019
<b>Email</b>	<u><a href="mailto:sheshadri.krishnapura@relianceada.com">sheshadri.krishnapura@relianceada.com</a></u> amit.as.tomar@relianceada.com	<u><a href="mailto:robin.sebastian@relianceada.com">robin.sebastian@relianceada.com</a></u> pankaj.goyal@relianceada.com



## **SECTION – II: INSTRUCTION TO BIDDERS**

### **1.00 GENERAL**

BSES Rajdhani Power Ltd, hereinafter referred to as "The Company" are desirous of awarding work for "Supply, Installation, Testing & Commissioning of 33 kV EHV lines & 11 kV/LT distribution network including dismantling on single point responsibility basis in connection with & shifting/relocation of 11 kV & 33 kV feeders at Sarai Kale Khan (NCRTC)

### **2.00 SCOPE OF WORK**

The scope of the work is as per BOQ in the tender.

### **3.00 DISCLAIMER**

This Document includes statements, which reflect various assumptions, which may or may not be correct. Each Bidder shall conduct its own estimation and analysis and should check the accuracy, reliability and completeness of the information in this Document and obtain independent advice from appropriate sources in their own interest.

Neither Purchaser nor its employees will have any liability whatsoever to any Bidder or any other person under the law or contract, the principles of restitution or unjust enrichment or otherwise for any loss, expense or damage whatsoever which may arise from or be incurred or suffered in connection with anything contained in this Document, any matter deemed to form part of this Document, provision of Services and any other information supplied by or on behalf of Purchaser or its employees, or otherwise arising in any way from the selection process for the Supply.

Though adequate care has been taken while issuing the Bid document, the Bidder should satisfy itself that Documents are complete in all respects. Intimation of any discrepancy shall be given to this office immediately.

This Document and the information contained herein are Strictly Confidential and are for the use of only the person(s) to whom it is issued. It may not be copied or distributed by the recipient to third parties (other than in confidence to the recipient's professional advisors).

### **4.00 COST OF BIDDING**

The Bidder shall bear all cost associated with the preparation and submission of its Bid and the company will be in no case be responsible or liable for those costs.

### **5.00 BIDDING DOCUMENTS**

The Scope of Work, Bidding Procedures and Contract Terms are described in the Bidding Documents. In addition to the covering letter accompanying Bidding Documents, the Bidding Documents include:

- Request for Quotation (RFQ) - Section - I
- Instructions to Bidders (ITB) - Section - II
- Special Terms & Conditions of Contract (SCC) - Section –III
- General Terms and Condition Supply (GCC-Supply) - Section –IV
- Price Format Supply- Section V
- General Terms and Condition Erection, Testing & Commissioning (GCC-ETC) - Section –VI
- Price Format Erection, Testing & Commissioning - Section VII
- Grand Summary of the Quoted Price – Section VIII
- Vendor Code of Conduct - Section IX

Scope Demarcation and Route Map – Annexure II  
Technical Specifications - Annexure III

The Bidder is expected to examine the Bidding Documents, including all Instructions, Forms, Terms and Specifications. Failure to furnish all information required by the Bidding Documents or submission of a Bid not substantially responsive to the Bidding Documents in every respect will may result in the rejection of the Bid.

**6.00 AMENDMENT OF BIDDING DOCUMENTS**

At any time prior to the deadline for submission of Bids, the Company may for any reasons, whether at its own initiative or in response to a clarification requested by a prospective Bidder, modify the Bidding Documents by amendment.

The Amendment shall be part of the Bidding Documents, pursuant to Clause 5.00, and it will be notified in web site [www.bsesdelhi.com](http://www.bsesdelhi.com), and will be binding on them.

In order to afford prospective Bidders reasonable time in which to take the Amendment into account in preparing their Bids, the Company may, at its discretion, extend the deadline for the submission of Bids. The same shall be published as a corrigendum in website [www.bsesdelhi.com](http://www.bsesdelhi.com).

Purchaser shall reserve the rights to following

- extend due date of submission
- modify tender document in part/whole
- cancel the entire tender

**Bidders are requested to visit website regularly for any modification/clarification/corrigendum/addendum of the bid documents**

**7.00 LANGUAGE OF BID**

The Bid prepared by the Bidder, and all correspondence and documents relating to the Bid exchanged by the Bidder and the Purchaser shall be written in the English Language. Any printed literature furnished by the Bidder may be written in another Language, provided that this literature is accompanied by English translation, in which case, for purposes of interpretation of the Bid, the English translation shall govern.

**8.00 DOCUMENTS COMPRISING THE BID**

The Bid prepared and submitted by the Bidder shall comprise the following components:

- Bid Form, Price & other Schedules (STRICTLY AS PER FORMAT) and Technical Data Sheets completed in accordance with Technical Specification
- All the Bids must be accompanied with the required EMD as mentioned in the Section-I against each tender.
- Tender documents duly stamped and signed on each page by authorized signatory

**9.00 BID FORM**

9.01 The Bidder shall submit one "Original" and one "Copy" of the Un-priced Bid Form, Price Schedules & Technical Data Sheets duly filled in as per attached specification/BOM etc enclosed.

**9.02 EMD**

The bidder shall furnish, as part of its bid, an EMD amounting as specified in the RFQ. The EMD is required to protect the Purchaser against the risk of Bidder's conduct which would warrant forfeiture.

The EMD shall be denominated in any of the following form:

- (a) Banker's Cheque / Demand Draft/Pay Order drawn in favour of BSES Rajdhani Power Ltd, payable at Delhi.
- (b) Bank Guarantee valid for One hundred Twenty (120) days after due date of submission or amended due date of submission drawn in favour of BSES Rajdhani Power Ltd, BSES Bhawan, Nehru Place, New Delhi 110019

The EMD may be forfeited in case of:

- (a) The Bidder withdraws its bid during the period of specified bid validity

OR

- (b) The case of a successful Bidder, if the Bidder does not
  - (i) Accept the Purchase Order, or
  - (ii) Furnish the required performance security BG.

**10.00 BID PRICES**

10.01 Bidders shall quote for the entire Scope of Supply/Work with a break-up of prices for individual items and Taxes & Duties. The total Bid Price shall also cover all the Supplier's obligations mentioned in or reasonably to be inferred from the Bidding Documents in respect of Design, Supply, Transportation to site, Erection, testing & commissioning all in accordance with the requirement of Bidding Documents The Bidder shall complete the appropriate Price Schedules included herein, stating the Unit Price for each item & total Price with taxes, duties & freight upto destination.

10.02 The prices offered shall be inclusive of all costs as well as Duties, Taxes and Levies paid or payable during execution of the supply work, breakup of price constituents, should be there. The Bidder is required, at his expense, to obtain all the information he may require to enable him to submit his tender including necessary visits to the site to ascertain the local conditions, procurement of necessary materials, labour, etc., requirements of the local/government/public authorities in such matters.

10.03 Prices quoted by the Bidder shall be **"Firm"** and not subject to any price adjustment during the performance of the Contract. **A Bid submitted with an adjustable price/ Price Variation Clause will be treated as non-responsive and rejected.**

**11.00 BID CURRENCIES**

Prices shall be quoted in Indian Rupees Only.

**12.00 PERIOD OF VALIDITY OF BIDS**

12.01 Bids shall remain valid for 120 days from the due date of submission of the Bid & subsequent corrigendum/amendment/extension of due date of submission.

12.02 Notwithstanding Clause 12.01 above, the Purchaser may solicit the Bidder's consent to an extension of the Period of Bid Validity. The request and the responses thereto shall be made in writing and sent by post/courier.

### 13.00 **ALTERNATIVE BIDS**

Bidders shall submit Bids, which comply with the Bidding Documents. Alternative Bids will not be considered. The attention of Bidders is drawn to the provisions regarding the rejection of Bids in the terms and conditions, which are not substantially responsive to the requirements of the Bidding Documents.

### 14.00 **FORMAT AND SIGNING OF BID**

14.01 The original Bid Form and accompanying documents, clearly marked "Original Bid" and "copy" must be received by the Purchaser at the date, time and place specified pursuant to Clauses 15.0 and 16.0. In the event of any discrepancy between the original and the copy, the original shall govern.

14.02 The original and copies of the Bid shall be typed or written in indelible ink and shall be signed by the Bidder or a person or persons duly authorized to sign on behalf of the Bidder. **Such authorization shall be indicated by written Power-of-Authority accompanying the Bid.**

14.03 The Bid shall contain no interlineations, erasures or overwriting except as necessary to correct errors made by the Bidder, in which case such corrections shall be initialed by the person or persons signing the Bid.

### 15.00 **SEALING AND MARKING OF BIDS**

15.01 Bid submission: One original & one Copy (hard copies) of all the Bid Documents shall be sealed and submitted to the Purchaser before the closing time for submission of the bid.

15.02 The Technical Documents and the EMD shall be enclosed in a sealed envelope and the said envelope shall be super scribed with —"Technical & EMD". The price bid shall be inside another sealed envelope with super scribed "Financial Bid ". Both these envelopes shall be sealed inside another big envelope. All the envelopes should bear the Name and Address of the Bidder and marking for the Original and Copy. The envelopes should be super scribed with —"Tender Notice No. & Due date of opening".

15.03 The Bidder has the option of sending the Bids in person. Bids submitted by Email/Telex/Telegram /Fax will be rejected. No request from any Bidder to the Purchaser to collect the proposals from Courier/Airlines/Cargo Agents etc shall be entertained by the Purchaser.

### 16.00 **DEADLINE FOR SUBMISSION OF BIDS**

16.01 The original Bid, together with the required copies, must be received by the Purchaser at the address specified earlier.

16.02 The Purchaser may, at its discretion, extend the deadline for the submission of Bids by amending the Bidding Documents, in which case all rights and obligations of the Purchaser and Bidders previously subject to the deadline will thereafter be subject to the deadline as extended.

### 17.00 **ONE BID PER BIDDER**

Each Bidder shall submit only one Bid by itself. **No Joint Venture is acceptable.** A Bidder who submits or participates in more than one Bid will cause all those Bids to be rejected.

**18.00 LATE BIDS**

Any Bid received by the Purchaser after the deadline for submission of Bids prescribed by the Purchaser, pursuant to Clause 16.0, will be declared "Late" and shall be rejected and returned unopened to the Bidder.

**19.00 MODIFICATIONS AND WITHDRAWAL OF BIDS**

19.01 The Bidder is not allowed to modify or withdraw its Bid after the Bid's submission.

**20.00 PROCESS TO BE CONFIDENTIAL**

Information relating to the examination, clarification, evaluation and comparison of Bids and recommendations for the award of a contract shall not be disclosed to Bidders or any other persons not officially concerned with such process. Any effort by a Bidder to influence the Purchaser's processing of Bids or award decisions may result in the rejection of the Bidder's Bid.

**21.00 CLARIFICATION OF BIDS**

To assist in the examination, evaluation and comparison of Bids, the Purchaser may, at its discretion, ask the Bidder for a clarification of its Bid. All responses to requests for clarification shall be in writing and no change in the price or substance of the Bid shall be sought, offered or permitted.

**22.0 PRELIMINARY EXAMINATION OF BIDS / RESPONSIVENESS**

22.01 Purchaser will examine the Bids to determine whether they are complete, whether any computational errors have been made, whether required sureties have been furnished, whether the documents have been properly signed, and whether the Bids are generally in order. Purchaser may ask for submission of original documents in order to verify the documents submitted in support of qualification criteria.

22.02 Arithmetical errors will be rectified on the following basis. If there is a discrepancy between the unit price and the total price per item that is obtained by multiplying the unit price and quantity, the unit price shall prevail and the total price per item will be corrected. If there is a discrepancy between the Total Amount and the sum of the total price per item, the sum of the total price per item shall prevail and the Total Amount will be corrected.

22.03 Prior to the detailed evaluation, Purchaser will determine the substantial responsiveness of each Bid to the Bidding Documents including production capability and acceptable quality of the Goods offered. A substantially responsive Bid is one, which conforms to all the terms and conditions of the Bidding Documents without material deviation.

22.04 Bid determined as not substantially responsive will be rejected by the purchaser and/or the Purchaser and may not subsequently be made responsive by the Bidder by correction of the non - conformity.

**23.00 EVALUATION AND COMPARISON OF BIDS**

The evaluation of Bids shall be done based on the delivered cost competitiveness basis.

23.01 The evaluation of the Bids shall be a stage-wise procedure. The following stages are identified for evaluation purposes: In the first stage, the Bids would be subjected to a responsiveness check. The Technical Proposals and the Conditional ties of the Bidders would be evaluated.

23.02 Subsequently, the Financial Proposals along with Supplementary Financial Proposals, if any, of Bidders with Techno-commercially Acceptable Bids shall be considered for final evaluation.

23.03 The Purchaser's evaluation of a Bid will take into account, in addition to the Bid price, the following factors, in the manner and to the extent indicated in this Clause:

- Delivery Schedule
- Conformance to Qualifying Criteria
- Deviations from Bidding Documents

Bidders shall base their Bid price on the terms and conditions specified in the Bidding Documents.

The cost of all quantifiable deviations and omissions from the specification, terms and conditions specified in Bidding Documents shall be evaluated. The Purchaser will make its own assessment of the cost of any deviation for the purpose of ensuring fair comparison of Bids.

23.04 Any adjustments in price, which result from the above procedures, shall be added for the purposes of comparative evaluation only to arrive at an "Evaluated Bid Price". Bid Prices quoted by Bidders shall remain unaltered.

#### 24.00 **CONTACTING THE PURCHASER**

24.01 If any Bidder wishes to contact the Purchaser on any matter related to the Bid, from the time of Bid opening to the time of contract award, the same shall be done in writing only.

24.02 Any effort by a Bidder to influence the Purchaser and/or in the Purchaser's decisions in respect of Bid evaluation, Bid comparison or Contract Award, will result in the rejection of the Bidder's Bid.

#### 25.00 **THE PURCHASER 'S RIGHT TO ACCEPT ANY BID AND TO REJECT ANY OR ALL BIDS**

The Purchaser reserves the right to accept or reject any Bid and to annul the Bidding process and reject all Bids at any time prior to award of Contract, without thereby incurring any liability to the affected Bidder or Bidders or any obligation to inform the affected Bidder or Bidders of the grounds for the Purchaser's action.

#### 26.00 **AWARD OF CONTRACT**

26.01 The Purchaser will award the Contract to the successful Bidder whose Bid has been determined to be the lowest-evaluated responsive Bid, provided further that the Bidder has been determined to be qualified to satisfactorily perform the Contract. Purchaser reserves the right to award order to other bidders in the tender, provided it is required for timely execution of project & provided he agrees to come to the lowest rate.

26.02 **Splitting of Tendered Scope of works in two or more bidders:** BRPL reserve the right to split the tender scope amongst techno- commercially qualified bidders. The purchaser reserves all the rights to award the contract to one or more bidders to meet the timelines of the projects /scope of work or nullify the award decision without any reason.

26.03 The Purchaser intends to issue separate Purchase/Work Orders viz  
a) Purchase Order for Supply Portion of 11 KV & 33 KV circuits Part I & II  
b) Work Order for Installation, Testing & Commissioning of 11 KV & 33 KV circuits Part I & II

#### 27.00 **THE PURCHASER 'S RIGHT TO VARY QUANTITIES**

The Purchaser reserves the right to vary the quantity i.e. increase or decrease the numbers/quantities without any change in terms and conditions during the execution of the Order.

#### 28.00 **LETTER OF INTENT/ NOTIFICATION OF AWARD**

The letter of intent/ Notification of Award shall be issued to the successful Bidder whose bids have been considered responsive, techno-commercially acceptable and evaluated to be the lowest (L1). The successful Bidder shall be required to furnish a letter of acceptance within 7 days of issue of the letter of intent /Notification of Award by Purchaser. The date of LOI/LOA shall be treated as Start date of work.

**29.00 CONTRACT PERFORMANCE BANK GAURANTEE**

Within 15 days of the receipt of Notification of Award/ Letter of Intent/PO from the Purchaser, the successful Bidder shall furnish the Performance Bank Guarantee towards faithful performance of Contract for an amount of 10% (Ten percent) of the Contract Price. The Performance Bond shall be valid upto completion period/handing over, whichever is earlier plus 3 months claim period. Upon submission of the performance security, the EMD shall be released. 2 (two) nos. separate CPBG's shall be submitted against Supply, ETC.

**30.00 CORRUPT OR FRADULENT PRACTICES**

30.01 The Company requires that the Bidders observe the highest standard of ethics during the procurement and execution of the Project. In pursuance of this policy, the Company:

(a) Defines, for the purposes of this provision, the terms set forth below as follows:

"Corrupt practice" means behavior on the part of officials in the public or private sectors by which they improperly and unlawfully enrich themselves and/or those close to them, or induce others to do so, by misusing the position in which they are placed, and it includes the offering, giving, receiving, or soliciting of anything of value to influence the action of any such official in the procurement process or in contract execution; and

"Fraudulent practice" means a misrepresentation of facts in order to influence a award process or the execution of a contract to the detriment of the Company, and includes collusive practice among Bidders (prior to or after Bid submission) designed to establish Bid prices at artificial non -competitive levels and to deprive the Company of the benefits of free and open competition.

(b) Will reject a proposal for award if it determines that the Bidder recommended for award has engaged in corrupt or fraudulent practices in competing for the contract in question ;

(c) Will declare a firm ineligible, either indefinitely or for a stated period of time, to be awarded a contract if it at any time determines that the firm has engaged in corrupt or fraudulent practices in competing for, or in executing, a contract.

30.02 Furthermore, Bidders shall be aware of the provision stated in the Terms and Conditions of Contract.

**31.00 COMPLETION PERIOD**

Within 4 months from the date of issuance of LOI/Order.

### **Section III: SPECIAL TERMS AND CONDITIONS OF CONTRACT**

- 1.1. Bidders are requested to visit the site to understand the scope of work, site conditions and requirements prior to Bidding. Hence, no price/time escalation shall be admissible on these accounts.
- 1.2. The scope of this tender includes supply , survey , design , engineering , manufacturer , shop testing , inspection , packing , dispatch , loading , unloading and storage at site, storage and construction insurance , assembly , erection ,structural , complete pre-commissioning checks , testing and commissioning at site , obtaining statutory clearance & certification from state electrical inspector and handing over to owner after successful laying of EHV & 11 KV Cables, dismantling of existing circuits and installation of RMUs, Package Substations (PSS), etc as per BOQ ,with required accessories on single point responsibility basis.
- 1.3. The scope includes supply of all barricading, free issued materials (including installation, transportation, loading & unloading), dewatering, watch and ward and transportation of scrap (generated at Site), balance free-issued material, dismantled material from site to BRPL store including loading & unloading and no additional charges shall be paid against these activities. Used barricading material will be taken back by bidder soon after job is handed over or as directed by BRPL Engineer-In-Charge (E-I-C). No additional cost for these items will be paid to the Bidder. Any leakage, pilferage and damage of the material shall be in vendor's scope.
- 1.4. Delivery of cable at site and all other equipments/accessories have to be aligned as per site requirements and progress.
- 1.5. Since the work is required to be done parallel on both the 33kV & 11KV circuits, Bidder needs to deploy separate manpower for both the sites. Proper Co-ordination is required while working along the common route of the two circuits. Separate machinery is also required to be deployed for working in trenchless part of both the circuits.
- 1.6. Joints & Terminations installation shall only be done by OEM. No additional cost for this item will be paid to the Bidder. Contractor to provide all support to the Jointers for doing Joints & Terminations of Joint Kits.
- 1.7. Prices for all the activities shall be FIRM till the actual completion of the job. Statutory variation will be allowed for direct supplies only wherever breakup of Taxes & Duties are available in Price Bid. In case bidder has not submitted any price breakup, no variation on account of statutory variation shall be paid extra by BRPL.
- 1.8. There will be no price escalation given to bidder even if there is delay in the project due to ROW permission.
- 1.9. Permission from road owning agencies & statutory clearance for road cutting shall be in the scope of bidder. However statutory fees will be borne by BRPL.
- 1.10. Bidder has to submit the technical parameters with details of Spares for each rating with catalogue, reference codes etc.
- 1.11. Wherever BRPL specifications are not available relevant IS/IEC to be followed. All Drawings mentioned in the Tender Specification and other required for the completeness of the tender shall be submitted. Drawing submission process shall not be deemed complete if all the requirements are not complied during the submission of the same.



- 1.12. The bidder should have own testing equipment's/they have to provide like IR Tester, Hi Pot Test Kit and Earth Tester and Sheath Integrity test kit with Calibration Certificates for testing the cables. Sheath integrity test will in scope bidder before charging of cable(for 66 kV Cable only)
- 1.13. The Bidder should have own Safety equipment like Neon Tester, Portable Earth, Earthing discharge rod etc. along with Calibration Certificates of all the equipment.
- 1.14. The Bidder should have all major tools and tackles for cable laying like Bench Machine, Rollers, Jack for lifting the Cable drum along with calibration certificates etc.
- 1.15. Bidder has to submit the item wise price bifurcation in bid. Unprice copy must be attached with the Part A. Reverse Auction will be carried out on Lump sum Basis/Total Landed Cost i.e. Supply + ETC
- 1.16. Any other material not specifically mentioned above but required for successful commissioning and operation is in the scope of bidder. Prior approval shall be taken from central engineering department before execution. Commercial approval shall be taken from C&M Department before execution.
- 1.17. Successful bidder has to adhere to the statutory compliance.
- 1.18. Successful Bidder has to depute the safety officer and quality officer separately at site for whole duration and they have to submit the safety report and quality report to BRPL E-I-C on weekly basis.
- 1.19. Successful bidder has to send the weekly progress report to BRPL EIC.
- 1.20. In case of any major deviation, deletion or addition which bidder may feel is relevant to this project & for its safe operation and completion of works; Bidder may clearly highlight and communicate the same to the purchaser with his bid.
- 1.21. Necessary Statutory Clearances from CEI of Delhi & any other authority for energizing shall be in the scope of this tender. However, any statutory fees shall be borne by BRPL on production of documentary evidence.
- 1.22. Taking over after commissioning of the complete system and final approval of Electrical Inspector & Compliance to punch points observed to the satisfaction of Projects as per statutory requirements, system shall be handed over to BRPL.
- 1.23. **Guarantee period/Defect Liability period:**

The Guarantee Period will be equipment/service/work specific and shall be as specified in the Technical Specifications for the equipment/material/service/work and where Technical specifications are not part of contract documents or guarantee period is not specified in the Technical specifications, the guarantee period shall be as per the Special Terms and Conditions of the Contract. In case of no mention of the guarantee period in Technical specifications, Defect liability period will be 24 Months from the Date of Commissioning or 30 months from the date of delivery of final lot of supplies made, whichever is later.

For Cable & Joints, RMU & PSS: The defect liability period shall be 60 months from the date of commissioning or 66 months from the date of delivery whichever is later.

If during the defects liability period any materials / items are found to be defective, these shall be replaced or rectified by the bidder at his own cost within 30 days from the date of receipt of intimation

- 1.24. **Failure during Guarantee Period:**

If the equipment and material supplied/service or work rendered under the contract fails to perform its due, rated & intended quality performance, during the Guarantee period, the bidder is liable to undertake repair/rectify/replace the equipment and material supplied/service or work rendered under the contract within time frame as specified below at bidder's cost to make the equipment and material supplied/service or work rendered under the contract of performing its due, rated and intended quality performance. If bidder fails to repair/rectify/replace the equipment or material supplied/service or work rendered under the contract, failed in Guarantee Period, purchaser will be at liberty to get the same done at bidder's risks and costs and recover all such expenses plus the purchaser own charges (@ 15% of expenses incurred), from the bidder or from the "Performance Bank Guarantee" as the case may be.

If during the Warranty/ Guarantee period some parts of the supplies are replaced owing to the defects/damages under the Warranty, the Warranty period for such replaced parts shall be until the expiry of twelve months from the date of such replacement or renewal or until the end of original Guarantee period, whichever is later.

- a) Service Engineer Availability to Attend, Identify & Restore Defects (Minor) of materials/Equipment's under Guarantee Period within 48 Working Hours (Exclusion of Material Support Cases)
- b) Spare Material Delivery for rectification of defect (Major) Under Guarantee Period within Two Weeks. Bidder must keep Requisite Inventory of Critical Spares & Other Equipments Covered in Guarantee Period to Restore Equipment within Two Weeks.
- c) In Case Of Complete Replacement of material, within a Period of 4 Weeks.

**Note:** BRPL is in the business of Power distribution and is committed to providing reliable and continuous power supply to its customers. In case of any fault in the system, BRPL's top most priority is to rectify the fault and restore the system as soon as possible and maintain the supply.

If during the defect liability period any fault occurs in the system due to faulty materials, design or workmanship, BRPL shall intimate the vendor of such occurrence for taking immediate corrective action.

However, if the situation, in BRPL's sole discretion warrants an emergency restoration, it reserves the right to take immediate action for identifying the fault and restoring the system with available resources & materials or with help from any other third party agency under intimation to the Vendor. All costs of replacement, substitution, shipping, labour and other related expenses including taxes and levies incurred in connection with the restoration of fault plus 15% of expenses incurred as administrative overheads shall be for the account of Vendor. BRPL will charge the vendor for the costs incurred for fault restoration or may set off such costs against any amounts payable by BRPL to the Vendor or deduct from the PBG submitted by the Vendor. Vendor shall pay BRPL the amount within 30 days.

Root cause analysis of the fault shall be done jointly by BRPL's CES & O&M teams and Vendor. In case the fault is due to any reason other than faulty materials, design or workmanship, Vendor shall be exempted from any further action or Cost.

1.25. All the bay equipment (i.e- LA, CT, PT, Disc Insulator, String, Suspension Insulator, Bushing etc.) shall be Polymeric type in the place of porcelain with creepage 31mm/kV. Rest of the parameter to be followed as per tech spec.

#### 1.26. PROJECT INFORMATION & COMPLETION

The contractor shall be fully responsible to complete the project in time. It is desired that the project should be completed as per the schedule from the date of LOI or purchase order whichever is earlier. The detailed

completion schedule shall be prepared by vendor and shall be submitted at the time of detailed engineering for approval. Vendor has to submit the progress report fortnightly in the format attached (Appendix VIII) with this tender/as asked by the Purchaser.

#### 1.27. PROJECT IMPLEMENTATION & EXECUTION CONTROL

The bidders are requested to submit the following along with the bid, about the project implementation & execution methodology.

- a) Write up/overview of project Plan
- b) Implementation Methodology
- c) Project Organization Chart for Representatives, Project Office & site office teams along with the functions.
- d) Bar Chart & Network Diagram (with critical path) for various activities to achieve scheduled completion.

### **SECTION IV: GENERAL TERMS AND CONDITIONS - SUPPLY**

- 1.01** All the Bids shall be prepared and submitted in accordance with these instructions.
- 1.02** Bidder shall bear all costs associated with the preparation and delivery of its Bid, and the Purchaser will in no case shall be responsible or liable for these costs.
- 1.03** The Bid should be submitted by the Bidder in whose name the bid document has been issued and under no circumstances it shall be transferred /sold to the other party.
- 1.04** The Purchaser reserves the right to request for any additional information and also reserves the right to reject the proposal of any Bidder, if in the opinion of the Purchaser, the data in support of RFQ requirement is incomplete.
- 1.05** The Bidder is expected to examine all instructions, forms, terms & conditions and specifications in the Bid Documents. Failure to furnish all information required in the Bid Documents or submission of a Bid not substantially responsive to the Bid Documents in every respect may result in rejection of the Bid. However, the Purchaser's decision in regard to the responsiveness and rejection of bids shall be final and binding without any obligation, financial or otherwise, on the Purchaser.
- 2.0 Definition of Terms**
- 2.01** "Purchaser" shall mean BSES Rajdhani Power Limited, on whose behalf this bid enquiry is issued by its authorized representative / officers.
- 2.02** "Bidder" shall mean the firm who quotes against this bid enquiry issued by the Purchaser. "Supplier" or "Supplier" shall mean the successful Bidder and/or Bidders whose bid has been accepted by the Purchaser and on whom the "Letter of Acceptance" is placed by the Purchaser and shall include his heirs, legal representatives, successors and permitted assigns wherever the context so admits.
- 2.03** "Supply" shall mean the Scope of Contract as described.
- 2.04** "Specification" shall mean collectively all the terms and stipulations contained in those portions of this bid document known as RFQ, Commercial Terms & Condition, Instructions to Bidders, Technical Specifications and the Amendments, Revisions, Deletions or Additions, as may be made by the Purchaser from time to time.
- 2.05** "Letter of Acceptance" shall mean the official notice issued by the Purchaser notifying the Supplier that his proposal has been accepted and it shall include amendments thereto, if any, issued by the Purchaser. The

"Letter of Acceptance" issued by the Purchaser shall be binding on the "Supplier" The date of Letter of Acceptance shall be taken as the effective date of the commencement of contract.

- 2.06** "Month" shall mean the calendar month and "Day" shall mean the calendar day.
- 2.07** "Codes and Standards" shall mean all the applicable codes and standards as indicated in the Specification.
- 2.08** "Offer Sheet" shall mean Bidder's firm offer submitted to BRPL in accordance with the specification.
- 2.09** "Contract" shall mean the "Letter of Acceptance/Purchase Order" issued by the Purchaser.
- 2.10** "Contract Price" shall mean the price referred to in the "Letter of Acceptance/Purchase Order".
- 2.11** "Contract Period" shall mean the period during which the "Contract" shall be executed as agreed between the Supplier and the Purchaser in the Contract inclusive of extended contract period for reason beyond the control of the Supplier and/or Purchaser due to force majeure.
- 2.12** "Acceptance" shall mean and deemed to include one or more of the following as will be stipulated in the specification:
- a) The written acceptance of material by the inspector at suppliers works to ship the materials.
  - b) Acceptance of material at Purchaser site stores after its receipt and due inspection/ testing and release of material acceptance voucher.
  - c) Where the scope of the contract includes supplying, acceptance shall mean issue of necessary equipment / material takeover receipt after installation & commissioning and final acceptance.

### **3.0 Contract Documents & Priority**

Contract Documents: The terms and conditions of the contract shall consist solely of these RFQ conditions and the offer sheet. The several documents forming the Contract are to be taken as mutually explanatory of one another, but in case of ambiguities or discrepancies, the same shall be explained and adjusted by the Purchaser, who shall thereupon issue to the Contractor, instructions thereon. In such event, unless otherwise provided in the Contract, the priority of the documents forming the Contract shall be as follows:

1. Any amendments to Contract
2. Commercial Terms & Conditions of the Contract
3. Clarifications/addendum/corrigendum to Tender
4. Terms & Conditions of the Tender

### **4.0 Scope of Supply -General**

- 4.01 The "Scope of Supply" shall be on the basis of Bidder's responsibility, completely covering the obligations, responsibility and supplies provided in this Bid enquiry whether implicit or explicit.
- 4.02 Bidder shall have to quote for the Bill of quantities as listed elsewhere.
- 4.03 All relevant drawings, data and instruction manuals.

### **5.0 Quality Assurance and Inspection**

- 5.01 Immediately on award of contract, the bidder shall prepare detailed quality assurance plan/test procedure identifying the various stages of manufacture, quality checks performed at each stage, raw material inspection and the Customer hold points. The document shall also furnish details of method of checking, inspection and acceptance standards / values and get the approval of Purchaser before proceeding with manufacturing. However, Purchaser shall have right to review the inspection reports, quality checks and results of suppliers in house inspection department which are not Customer hold points and the supplier shall comply with the remarks

made by purchaser or his representative on such reviews with regards to further testing, rectification or rejection, etc. In case of standard items, BRPL shall forward the standard QAP which is to be followed by vendor during manufacturing.

- 5.02 Witness and Hold points are critical steps in manufacturing, inspection and testing where the supplier is obliged to notify the Purchaser in advance so that it may be witnessed by the Purchaser. Final inspection is a mandatory hold point. The supplier can proceed with the work past a hold point only after clearance by purchaser or a witness waiver letter from BRPL.
- 5.03 The performance of waiver of QA activity by Purchaser at any stage of manufacturing does not relieve the supplier of any obligation to perform in accordance with and meet all the requirements of the procurement documents and also all the codes & reference documents mentioned in the procurement document nor shall it preclude subsequent rejection by the purchaser.
- 5.04 On completion of manufacturing the items can only be dispatched after receipt of dispatch instructions issued by the Purchaser.
- 5.05 All in-house testing and inspection shall be done without any extra cost. The in-house inspection shall be carried out in presence of BRPL/BRPL authorized third party inspection agency. Cost of Futile/abortive visit(s) shall be debited from the invoices
- 5.06 Purchaser reserves the right to send any material being supplied to any recognized laboratory for testing, wherever necessary and the cost of testing shall be borne by the Bidder. In case the material is found not in order with the technical requirement / specification, the charges along with any other penalty which may be levied is to be borne by the bidder. To avoid any complaint the supplier is advised to send his representative to the stores to see that the material sent for testing is being sealed in the presence of bidder's representative.

## **6.0 Packing, Packing List & Marking**

- 6.01 **Packing:** Supplier shall pack or shall cause to be packed all Commodities in crates/boxes/drums/containers/cartons and otherwise in such a manner as shall be reasonably suitable for shipment by road or rail to BRPL, Delhi/New Delhi stores/site without undue risk of damage in transit.
- 6.02 **Packing List:** The contents of each package shall be itemized on a detailed list showing the exact weight, extreme outside dimensions (length, width & weight) of each container/box/drum/carton, Item SAP Code, PO No & date. One copy of the packing list shall be enclosed in each package delivered.

## **7.01 Price basis for supply of materials**

Bidder to quote their prices on Landed Cost Basis and separate price for each item.

FIRM prices for supply to BRPL Delhi/New Delhi stores inclusive of packing, forwarding, loading at manufacturer's premises, payment of all taxes, GST, Freight, any other local charges etc.

The above supply prices shall also include unloading at BRPL Delhi/New Delhi stores/site.

Transit insurance will be arranged by bidder.

## **8.0 Terms of payment and billing – SUPPLY**

- a) 70% prorata of supply value shall be payable against R/A bills for supply of equipment and materials within 30 days against receipt of material at site and submission of following documents duly certified by BRPL Project-in-charge:

- i. Consignee copy of LR
  - ii. Detailed invoice showing commodity description, qty, unit & total price,
  - iii. Original certificate issued by BRPL confirming receipt of material at site & acceptance
  - iv. Dispatch clearance & inspection report issued by the inspection authority
  - v. Packing List, Test Reports
  - vi. Guarantee Certificate.
- b) 15% prorata after installation/erection of equipment duly certified by BRPL Project-in-charge
- c) 15% prorata after completion of successful acceptance testing, commissioning and Handing Over of the entire Installation and duly certified by BRPL Project-in-charge and submission of PBG of 10% of contract value valid up to Defect Liability period i.e. 24 months from the date of Handing over of entire Installation Plus 3 months towards Claim period.

## **9.0 Price Validity**

- 9.01 All bids submitted shall remain valid, firm and subject to unconditional acceptance by BRPL Delhi for 120 days from the due date of submission & subsequent corrigendum/amendment/extension of due date of submission. For awarded suppliers/contractors, the prices shall remain valid and firm till contract completion.

## **10.0 Performance Guarantee**

- 10.01 Bank guarantee shall be drawn in favour of "BSES Rajdhani Power Ltd" as applicable. The performance Bank guarantee shall be in the format as specified by BRPL.
- 10.02 Contract performance bank guarantee of total 10% of the contract price shall be submitted within 15 days of award of contract with the validity till completion of the contract period.
- 10.03 Contractor shall submit the performance bank guarantee equivalent to the 10% of the contract value at the time of claiming the last payment as per clause no. 8.0(C) (Terms of payment and billing – SUPPLY), with the validity of the bank guarantee till Defect Liability Period plus 3 months towards Claim period.

## **11.0 Forfeiture**

- 11.01 Each Performance Bond established under Clause 10.0 shall contain a statement that it shall be automatically and unconditionally forfeited without recourse and payable against the presentation by BRPL of this Performance Bond, to the relevant bank referred to above, together with a simple statement that supplier has failed to comply with any term or condition set forth in the Contract.
- 11.02 Each Performance BG established under will be automatically and unconditionally forfeited without recourse if BRPL at its sole discretion determines that supplier has failed to comply with any term or condition set forth in the contract.

## **12.0 Release**

All Performance Bonds will be released without interest within seven (7) days from the last date up to which the Performance Bond has to be kept valid (as defined in Clause 10.0) except for the case set forth in Clause 21.0.

**13.0 Guarantee of Performance**

The bidder shall stand guarantee that the equipment and material supplied/service or work rendered under the contract is free from design, manufacturing, material, construction, erection & installation and workmanship & quality defects and is capable of its due, rated and intended quality performance, as an integrated product delivered under the contract for a specific period termed as Guarantee Period. The bidder should also guarantee that the equipment/material is new and unused except for the usage required for the tests and checks required as part of quality assurance.

**14.0 Guarantee Period/Defects Liability Period**

The Guarantee Period will be equipment/service/work specific and shall be as specified in the Technical Specifications for the equipment/material/service/work and where Technical specifications are not part of contract documents or guarantee period is not specified in the Technical specifications, the guarantee period shall be as per the Special Terms and Conditions of the Contract. In case of no mention of the guarantee period in Technical specifications, Defect liability period will be 24 Months from the Date of Commissioning or 30 months from the date of delivery of final lot of supplies made, whichever is later.

For Cable & Joints, RMU and PSS: The defect liability period shall be 60 months from the date of commissioning or 66 months from the date of delivery whichever is later.

If during the defects liability period any materials / items are found to be defective, these shall be replaced or rectified by the bidder at his own cost within 30 days from the date of receipt of intimation.

Cost of repairs on failure in Guarantee Period:

The cost of repairs/rectification /replacement, apart from the actual cost of repairs/rectification/replacement is also inclusive of all bidder costs of required transportation, site inspection /mobilization/dismantling and re-installation costs as applicable, to be borne by the bidder. The bidder has to ensure that the interruption in the usage of intended purpose of the equipment is minimized to the maximum extent In lieu of the time taken for repairs/rectification/replacement.

**15.0 Latent Defect:**

Hidden defects in manufacturing or design of the product supplied and which could not be identified by the tests conducted but later manifested during operation of the equipment are termed as latent defects. Bidder shall further be responsible for 'free replacement' for another period of FIVE years from the end of the guarantee period for any 'Latent Defects' if noticed and reported by the Purchaser.

**16.0 Support beyond the Guarantee Period**

The Bidder shall ensure availability of spares and necessary support for a period of at least 10 years post completion of guarantee period of equipment /technology supplied against this contract. BRPL shall be duly intimated by the Vendor of End of Life Support for the product /technology supplied at least 12 months in advance.

**17.0 Return, Replacement or Substitution**

BRPL shall give Supplier notice of any defective Commodity promptly after becoming aware thereof. BRPL may at its discretion elect to return defective Commodities to Supplier for replacement, free of charge to BRPL, or

may reject such Commodities and purchase the same or similar Commodities from any third party. In the latter case BRPL shall furnish proof to Supplier of the cost of such substitute purchase. In either case, all costs of any replacement, substitution, shipping, labour and other related expenses incurred in connection with the return and replacement or for the substitute purchase of a Commodity hereunder should be for the account of Supplier. BRPL may set off such costs against any amounts payable by BRPL to Supplier. Supplier shall reimburse BRPL for the amount, if any, by which the price of a substitute Commodity exceeds the price for such Commodity as quoted in the Bid.

**18.0 Effective Date of Commencement of Contract:**

The date of the issuance of the Letter of Acceptance/Purchase Order shall be treated as the effective date of the commencement of Contract.

**19.0 Time – The Essence of Contract**

The time and the date of completion of the "Supply" as stipulated in the Letter Of Acceptance / Purchase order issued to the Supplier shall be deemed to be the essence of the "Contract". The Supply has to be completed not later than the aforesaid Schedule and date of completion of supply.

**20.0 The Laws and Jurisdiction of Contract:**

The laws applicable to this Contract shall be the Laws in force in India. To the best of their ability, the parties hereto shall endeavor to resolve amicably between themselves all disputes arising in connection with this work order. If the same remain unresolved within thirty (30) days of the matter being raised by either party, either party may refer the dispute for adjudication by arbitration. The arbitration shall be undertaken by the sole arbitrator jointly appointed by the parties. In case the parties fail to arrive at consensus to appoint the sole arbitrator, either party may approach the Court for appointing an arbitrator under Section 11 of the Arbitration and Conciliation Act, 1996 and the award of the said sole arbitrator, shall be final and binding upon the parties. The arbitration proceeding shall be conducted in accordance with this provisions of the Indian Arbitration & Conciliation Act, 1996 (as amended up to date) and the venue of such arbitration shall be the city of New Delhi only. The Arbitration shall be conducted in English language only. The courts at Delhi shall have the exclusive jurisdiction over the subject matter of Arbitration/dispute. The cost of the Arbitration shall be equally shared by the parties as per directions of the Sole Arbitrator.

**21.0 Events of Default**

21.01 Events of Default. Each of the following events or occurrences shall constitute an event of default ("Event of Default") under the Contract:

- (a) Supplier fails or refuses to pay any amounts due under the Contract;
- (b) Supplier fails or refuses to deliver Commodities conforming to this RFQ/ specifications, or fails to deliver Commodities within the period specified in P.O. or any extension thereof
- (c) Supplier becomes insolvent or unable to pay its debts when due, or commits any act of bankruptcy, such as filing any petition in any bankruptcy, winding-up or reorganization proceeding, or acknowledges in writing its insolvency or inability to pay its debts; or the Supplier's creditors file any petition relating to bankruptcy of Supplier;
- (d) Supplier otherwise fails or refuses to perform or observe any term or condition of the Contract and such failure is not remediable or, if remediable, continues for a period of 30 days after receipt by the Supplier of notice of such failure from BRPL.



**22.0 Consequences of Default**

- (a) If an Event of Default shall occur and be continuing, BRPL may forthwith terminate the Contract by written notice.
- (b) In the event of an Event of Default, BRPL may, without prejudice to any other right granted to it by law, or the Contract, take any or all of the following actions;
  - (i) present for ` to the relevant bank the Performance Bond;
  - (ii) Purchase the same or similar Commodities from any third party; and/or
  - (iii) Recover any losses and/or additional expenses BRPL may incur as a result of Supplier's default.

**23.0 Liquidated Damages**

- 23.01 If supply of items / equipment is delayed beyond the supply schedule as stipulated in LOI/PO, then the Supplier shall be liable to pay the Purchaser for delay a sum of 0.5% (half percent) of the total price for every week of delay or part thereof for undelivered units.
- 23.02 The total amount for delay under the contract will be subject to a maximum of ten percent (10%) of the total contract value.
- 23.03 The Purchaser may, without prejudice to any method of recovery, deduct the amount for such damages from any amount due or which may become due to the Supplier or from the Performance Bond or file a claim against the supplier.

**24.0 Statutory variation in Taxes and Duties**

The total order value shall remain **FIRM** within stipulated delivery period and shall not be adjusted on account of any price increase/variations in commodities & raw materials. However Statutory Taxes, duties and Levies imposed by Competent Authorities by way of fresh notification(s) within the stipulated delivery period shall be borne by BRPL on submission of necessary documents claiming such variation. The variation will be applicable only on such value wherever price breakup of same is submitted by vendor/available in PO/WO

**25.0 Force Majeure**

## 25.01 General

An "Event of Force Majeure" shall mean any event or circumstance not within the reasonable control directly or indirectly, of the Party affected, but only if and to the extent that:

- (i) Such event or circumstance materially and adversely affects the ability of the affected Party to perform its obligations under this Contract, and the affected Party has taken all reasonable precautions, due care and reasonable alternative measures in order to prevent or avoid the effect of such event on the affected party's ability to perform its obligations under this Contract and to mitigate the consequences thereof.
- (ii) For the avoidance of doubt, if such event or circumstance would not have materially and adversely affected the performance of the affected party had such affected party followed good industry practice, such event or circumstance shall not constitute force majeure.

- (iii) Such event is not the direct or indirect result of the failure of such Party to perform any of its obligations under this Contract.
  - (iv) Such Party has given the other Party prompt notice describing such events, the effect thereof and the actions being taken in order to comply with above clause.
- 25.02 Specific Events of Force Majeure subject to the provisions of above clause, Events of Force Majeure shall include only the following to the extent that they or their consequences satisfy the above requirements:
- (i) The following events and circumstances:
    - a) Effect of any natural element or other acts of God, including but not limited to storm, flood, earthquake, lightning, cyclone, landslides or other natural disasters.
    - b) Explosions or fires
  - (ii) War declared by the Government of India, provided that the ports at Mumbai are declared as a war zone.
  - (iii) Dangers of navigation, perils of the sea.
- 25.03 Notice of Events of Force Majeure If a force majeure event prevents a party from performing any obligations under the Contract in part or in full that party shall:
- i) Immediately notify the other party in writing of the force majeure events within 7(seven) working days of the occurrence of the force majeure event
  - ii) Be entitled to suspend performance of the obligation under the Contract which is affected by force majeure event for the duration of the force majeure event.
  - iii) Use all reasonable efforts to resume full performance of the obligation as soon as practicable
  - iv) Keep the other party informed of all such efforts to resume full performance of the obligation on a regular basis.
  - v) Provide prompt notice of the resumption of full performance or obligation to the other party.
- 25.04 Mitigation of Events of Force Majeure Each Party shall:
- (i) Make all reasonable efforts to prevent and reduce to a minimum and mitigate the effect of any delay occasioned by an Event of Force Majeure including recourse to alternate methods of satisfying its obligations under the Contract;
  - (ii) Use its best efforts to ensure resumption of normal performance after the termination of any Event of Force Majeure and shall perform its obligations to the maximum extent practicable as agreed between the Parties; and
  - (iii) Keep the other Party informed at regular intervals of the circumstances concerning the event of Force Majeure, with best estimates as to its likely continuation and what measures or contingency planning it is taking to mitigate and or terminate the Event of Force Majeure.
- 25.05 Burden of Proof In the event that the Parties are unable in good faith to agree that a Force Majeure event has occurred to an affected party, the parties shall resolve their dispute in accordance with the provisions of this Agreement. The burden of proof as to whether or not a force Majeure event has occurred shall be upon the party claiming that the force majeure event has occurred and that it is the affected party.
- 25.06 Termination for Certain Events of Force Majeure. If any obligation of any Party under the Contract is or is reasonably expected to be delayed or prevented by a Force Majeure event for a continuous period of more than 3 months, the Parties shall promptly discuss in good faith how to proceed with a view to reaching a solution on mutually agreed basis. If a solution on mutually agreed basis cannot be arrived at within a period of 30 days after the expiry of the period of three months, the Contract shall be terminated after the said period of 30 days and neither Party shall be liable to the other for any consequences arising on account of such termination.
- 25.07 The Purchaser may terminate the contract after giving 7(seven) days notice if any of following occurs:
- a) Contractor fails to complete execution of works within the approved schedule of works, terms and conditions

- b) In case the contractor commits any Act of Insolvency, or adjudged insolvent
- c) Has abandoned the contract
- d) Has failed to commence work or has suspended the progress of works
- e) Has failed to proceed the works with due diligence and failed to make such due progress

25.08 Limitation of Force Majeure event. The Supplier shall not be relieved of any obligation under the Contract solely because cost of performance is increased, whether as a consequence of adverse economic consequences or otherwise.

25.09 Extension of Contract Period due to Force Majeure event The Contract period may be extended by mutual agreement of Parties by way of an adjustment on account of any period during which an obligation of either Party is suspended due to a Force Majeure event.

25.10 Effect of Events of Force Majeure. Except as otherwise provided herein or may further be agreed between the Parties, either Party shall be excused from performance and neither Party shall be construed to be in default in respect of any obligations hereunder, for so long as failure to perform such obligations shall be due to an event of Force Majeure."

### **26.0 Transfer and Sub-Letting**

The Supplier shall not sublet, transfer, assign or otherwise part with the Contract or any part thereof, either directly or indirectly, without prior written permission of the Purchaser.

### **27.0 Recoveries**

When ever under this contract any money is recoverable from and payable by the bidder, the purchaser shall be entitled to recover such sum by appropriating in part or in whole by deducting any sum due to which any time thereafter may become due from the supplier in this or any other contract. Should the sum be not sufficient to cover the full amount recoverable the bidder shall pay to the purchaser on demand the remaining balance.

### **28.0 Waiver**

Failure to enforce any condition herein contained shall not operate as a waiver of the condition itself or any subsequent breach thereof.

### **29.0 Indemnification**

Notwithstanding contrary to anything contained in this RFQ, Supplier shall at his costs and risks make good any loss or damage to the property of the Purchaser and/or the other Supplier engaged by the Purchaser and/or the employees of the Purchaser and/or employees of the other Supplier engaged by the Purchaser whatsoever arising out of the negligence of the Supplier while performing the obligations under this contract.

### **30.0 Documentation:**

The Bidder's shall procure all equipment from BRPL approved sources as per attached specifications. The Bidder's shall submit 5 copies of Material/Type Test Certificates, O&M Manuals, and Approved & As-built drawings. The Bidder's shall ensure for the strict compliance to the specifications and Field Quality Procedures issued by BRPL Engineer in-charge.

### **31.0 Commissioning Spares**

Commissioning Spares shall be deemed to be included in the quoted prices

SECTION V  
**PRICE FORMAT – SUPPLY**

**Part I**

Project	Shifting/Relocation of 33kV feeders (IP to Kilokari Bay no. 1 & 3) and 33kV O/H D/C line Bay 25 & 37 at Sarai Kale khan_ NCRTC							
S.No.	A. Supply_Item Discriptions	UoM	Qty.	Basic (Rs)	Freight (Rs)	GST (Rs)	Unit Landed (Rs)	Total Landed Cost (Rs)
1	CBL,PWR,400MM2;3C;33KV;AL ARMD, XLPE, OFC embeded (OFC details: ITU-T G.657. A1 SINGLE MODE -36 NOS. OM-2 (50/125) MULTI MODE-12 NOS, 12 NOS OFC PER TUBE)	M	9200					
2	KIT STRT JNT 33KV 3CX400MM2 HS XLPE INCLUDING OFC JOINTING KIT	EA	62					
3	MRKR,CBL;ELEC BAL MRKR ACTIVE (AT EVERY JOINT)	Nos	62					
4	MRKR,CBL;ELEC SAL MRKR PASSIVE (AT EVERY 50M)	Nos	62					
5	CVR,ELECT ,RCC coffin cover(1 RCC COFFIN SHALL BE SUITABLE TO COVER NET JOINT)	Nos	62					
6	TAG,SFTY,RCTNGL;AL;MTLC (ALUMINIUM CABLE TAG). 3 MM THICK	NOS	227					
7	CVR,CBL;600X550X50MM;RCC	EA	2846					
8	Supply of HDPE pipes as per IS 4984,PN 6 class PE 80 - 180MM DIA	M	5640					
9	TAPE,SFTY BARR,150MM;PVC;DNGER 33KV BSE (WARNING TAPE)	M	1780					
10	Supply of Cable Route/Joint Marker as per approved drawing.For 33/66 KV cables.	Nos	62					
11	Supply of B Class GI Pipe 8" O.D.	M	144					

**Part II**

Project	<b>NCRTC_ Sarai Kale Khan Shifting_11kV Feeder</b>							
Sr No	A. Supply _Item Descriptions	UO M	Qty	Basic (Rs)	Freight (Rs)	GST (Rs)	Unit Landed (Rs)	Total Landed Cost (Rs)
1	SUBSTA,PKG,CONVENTIONAL DRY,1000KVA	NOS	1					
2	RNG MAIN UNT,OUTDR,3WAYS,11KV	NOS	1					
3	CBL,PWR,300MM2;4;1.1KV;AL;XLPE	M	1500					
4	CBL,PWR,FRLS;300MM2;3C;11KV	M	2200					
5	CBL,PWR,150MM2;4C;1.1KV;AL;XLPE	M	300					
6	END TERMINATION KITS- 4X150 SQMM XLPE	EA	6					
7	END TERM KIT HS 1.1 KV 4C 300MM2 XLPE	NOS	12					
8	TERM KIT HS I/D 11KV 3C 300MM2 XLPE	EA	8					
9	FDR PILLAR,ELEC,B1;415V;IP 55	NOS	2					
10	KIT STRT HS JNT- 3X300 SQMM XLPE	NOS	26					
11	CONDUIT,METAL,RIGID,100MM;GS	M	12					
12	TAPE,ELEC,18MM;PVC;BLACK	NOS	30					
13	TAPE,ELEC,18MM;PVC;BLUE	NOS	30					
14	TAPE,ELEC,1.8CM;PVC;RED	NOS	30					
15	TAPE,ELEC,1.8CM;PVC;YELLOW	NOS	30					
16	TAPE,ELEC,BLK;AMALGAMATING	NOS	1					
17	Supply of HDPE pipes as per IS 4984,PN6 class PE 80 - 160mm dia.	M	2050					
18	STRIP,MTLC,EARTHNG;50X6MM;MS GALVANIZED	KG	180					
19	KIT,CHEM EARTHING KIT	NOS	12					
20	BRD,SIGN,250MM;200MM;1.6MM;MS;D ANGER	NOS	6					
21	Supply of fire buckets filled with sand, including fabrication of frame/stand of suitable size, canopy, grouting on surface or wall, painting of frame including necessary hardware and consumables. 4 bucket stand	SET	1					
22	Supply of Bolts/ nuts(including erection)	KG	31.76					

**Appendix- I****COMMERCIAL TERMS AND CONDITIONS - SUPPLY**

Sl No	Item Description	AS PER BRPL	BIDDER'S CONFIRMATION
1	Validity	120 days from the due date of submission or amended due date of submission	
2	Price basis	a) <b>Firm</b> , FOR Delhi store basis. Prices shall be inclusive of all taxes & duties, freight up to Delhi stores. b) Unloading at stores - in vendor's scope c) Transit insurance in Bidder scope	
3	Payment terms	a. 70 % against R/A bills within 30 days against receipt of material at site b. 15% prorata after installation/erection of equipment c. 15% prorata after completion of successful acceptance testing, commissioning and Handing Over of the entire Installation and duly certified by BRPL Project-in-charge and submission of BG of 10% of contract value valid up to Defect Liability period i.e. 24 months from the date of Handing over of entire Installation Plus 3 months towards Claim period	
4	Completion time	4 months from date of LOI/Order	
5	Defect Liability period	24 months from the date of Handing over of entire Installation. For Cable & Joints, PSS and RMU: The defect liability period shall be 60 months from the date of commissioning or 66 months from the date of delivery whichever is later.	
6	Liquidated damages	0.5% of total price for every week delay subject to maximum of 10% of total contract value	
7	Contract Performance Bank Guarantee	10% (Ten percent) of the Contract Price valid up to completion period/handing over.	
8	Performance Bank Guarantee	10% (Ten percent) of the Contract Price valid up to Defect Liability Period plus 3 months towards claim period.	

**APPENDIX II****BID FORM**

To

Head of Department  
Contracts & Material Deptt.  
BSES Rajdhani Power Ltd  
New Delhi 110019

Sir,

1 We understand that BRPL is desirous of execution of  
.....(Name of work)

2 Having examined the Bidding Documents for the above named works, we the undersigned, offer to deliver the goods in full conformity with the Terms and Conditions and technical specifications for the sum indicated in Price Bid or such other sums as may be determined in accordance with the terms and conditions of the contract .The above amounts are in accordance with the Price Schedules attached herewith and are made part of this bid.

3 If our Bid is accepted, we under take to deliver the entire goods as) as per delivery schedule mentioned in Section IV from the date of award of purchase order/letter of intent.

4 If our Bid is accepted, we will furnish a performance bank guarantee for an amount of 10% (Ten)percent of the total contract value for due performance of the Contract in accordance with the Terms and Conditions.

5 We agree to abide by this Bid for a period of 120 days from the due date of bid submission & subsequent corrigendum/amendment/extension of due date of submission. It shall remain binding upon us and may be accepted at any time before the expiration of that period.

6 We declare that we have studied the provision of Indian Laws for supply of equipments/materials and the prices have been quoted accordingly.

7 Unless and until Letter of Intent is issued, this Bid, together with your written acceptance there of, shall constitute a binding contract between us.

8 We understand that you are not bound to accept the lowest, or any bid you may receive.

9 There is provision for Resolution of Disputes under this Contract, in accordance with the Laws and Jurisdiction of Contract.

Dated this..... day of..... 20.....

Signature..... In the capacity of

.....duly authorized to sign for

and on behalf of

(IN BLOCK CAPITALS).....

**Appendix III****ACCEPTANCE FORM FOR PARTICIPATION IN REVERSE AUCTION EVENT**

(To be signed & stamped by the bidder along-with bid)

BSES Rajdhani Power Ltd (BRPL) intends to use reverse auction through SAP-SRM tool as an integral part of entire tendering process. All techno-commercially qualified bidders shall participate in the reverse auction.

The following terms and conditions are deemed as accepted by the bidder on participation in the bid:-

1. In case of bidding through Internet medium, bidders are advised to ensure availability of all associated infrastructure as required to participate in the reverse auction event. Inability to bid due to telephone glitch, internet response issues, software & hardware hangs/failures, power failures or any other reason shall not be the responsibility of BRPL.
2. In case bidder fails to participate in the reverse auction event due to any reason whatsoever, it shall be presumed that the bidder has no further discounts to offer and the initial bid submitted by them as a part of tender shall be considered as bidder's Final No Regret offer. Any off-line price bids received from a bidder in lieu of non-participation in the reverse auction event shall be rejected by BRPL.
3. The bidder is advised to understand the auto bid process to safeguard themselves against any possibility of non-participation in the reverse auction event.
4. The bidder shall be prepared with competitive price quotes during the day of reverse auction event.
5. The prices quoted by bidder in reverse auction event shall be on FOR Landed cost BRPL Store/site basis inclusive of all relevant taxes, duties, levies, transportation charges etc.
6. The prices submitted by the bidder during reverse auction event shall be binding on the Bidder.
7. The bidder agrees to non-disclosure of trade information regarding bid details e.g. purchase, Identity, bid process/technology, bid documentation etc.
8. BRPL will make every effort to make the bid process transparent. However award decision of BRPL will be final and binding on the bidder.
9. The prices submitted during reverse auction event shall be binding on the bidder.
10. No request for Time extension of the reverse auction event shall be considered by BRPL.
11. BRPL shall provide the user id and password to the authorized representative of the bidder. Authorization letter in lieu of the same shall be submitted along with the signed and stamped acceptance form.
12. The original price bids of the bidders shall be reduced on pro-rata basis against each line item based on the final all inclusive prices offered during conclusion of the reverse auction event for arriving at contract amount



**APPENDIX IV****FORMAT FOR EMD BANK GUARANTEE**

*(To be issued in a Non Judicial Stamp Paper of Rs.50/-purchased in the name of the bank)*

Whereas [*name of the Bidder*] (herein after called the "Bidder") has submitted its bid dated [*date of submission of bid*] for the supply of [*name and/or description of the goods*] (here after called the "Bid").

KNOW ALL PEOPLE by these presents that WE [*name of bank*] at [*Branch Name and address*],having our registered office at[*address of the registered office of the bank*](herein after called the "Bank"),are bound unto BSES Rajdhani Power Ltd., with it's Corporate Office at BSES Bhawan Nehru Place, New Delhi -110019 ,(herein after called —the "Purchaser")in the sum of Rs. ....../- (Rupees ..... only) for which payment well and truly to be made to the said Purchaser, the Bank binds itself, its successors, and assigns by these presents.

Sealed with the Common Seal of the said Bank this\_\_\_\_\_ day of\_\_\_\_\_ 20\_\_\_\_\_.

THE CONDITIONS of this obligation are:

- 1 If the Bidder withdraws its Bid during the period of bid validity specified by the Bidder on the Bid Form ; or
2. If the Bidder, having been notified of the acceptance of its Bid by the Purchaser during the period of bid validity:
  - (a) Fails or refuses to execute the Contract Form, if required; or
  - (b) Fails or refuses to furnish the performance security, In accordance with the Instructions to Bidders/ Terms and Conditions;

We undertake to pay to the Purchaser up to the above amount upon receipt of its first written demand, without the Purchaser having to substantiate its demand, provided that is its demand the purchaser will note that amount claimed by it is due to it, owing to the occurrence of one or both of the two condition(s), specifying the occurred condition or condition(s).

This guarantee will remain in force up to and including One Hundred Twenty (120) days after the due date of submission bid, and any demand in respect thereof should reach the Bank not later than the above date.

(Stamp & signature of the bank)

Signature of the witness

**APPENDIX - V****LITIGATION HISTORY**

Year	Name of client	Details of contract & date	Cause of Litigation/ arbitration and dispute	Disputed amount

**APPENDIX - VI****CURRENT CONTRACT COMMITMENTS/ WORK IN PROGRESS**

Year	Name of client	Details of contract & date	Value of outstanding work	Estimated completion date

**APPENDIX - VII****FINANCIAL DATA**

(Duly Certified by Chartered Accountant)

	FY 18-19	FY 17-18	FY 16-17
Total assets			
Current assets			
Total Liability			
Current Liability			
Profit before taxes			
Profit after taxes			
Sales Turnover			

**APPENDIX VIII****Progress Report Format**

<b>SCHEDULE Format</b>									
<b>Section Name</b>	<b>Approx length</b>	<b>Material Availability</b>	<b>Digging</b>	<b>Preparing trench/HDPE Pipe</b>	<b>Cable Laying</b>	<b>Jointing</b>	<b>Back Fill</b>	<b>Issue</b>	<b>Remarks</b>
End termination									
Section 1									
Section 2									
Section 3									
Section 4									
Section X									
End termination									

<b>Cable laying and Joint completion</b>	
<b>Cable testing Date</b>	
<b>Electrical Inspection Date</b>	
<b>Final Energisation Date</b>	

**APPENDIX IX****CHECK LIST**

Sl No	Description	Compliance
1	INDEX	YES/NO
2	COVERING LETTER	YES/NO
3	BID FORM (UNPRICED) DULY SIGNED	YES/NO
4	BILL OF MATERIAL (UNPRICED)	YES/NO
5	DOCUMENTS IN SUPPORT OF QUALIFICATION CRITERIA	YES/NO
6	TECHNICAL BID	YES/NO
7	ACCEPTANCE TO COMMERCIAL TERMS AND CONDITIONS	YES/NO
8	FINANCIAL BID (IN SEALED ENVELOPE)	YES/NO
9	EMD IN PRESCRIBED FORMAT	YES/NO
10	DEMAND DRAFT OF RS 1000/- DRAWN IN FAVOUR OF BSES RAJDHANI POWER LTD	YES/NO
11	POWER OF ATTORNEY/AUTHORISATION LETTER FOR SIGNING THE BID	YES/NO
12	FINANCIAL DATA IN TABULAR FORMAT	YES/NO
13	LIST OF CURRENT COMMITMENTS/ WORK IN PROGRESS	YES/NO
14	BANK SOLVENCY CERTIFICATE	YES/NO
15	NO LITIGATION CERTIFICATE	YES/NO

## **SECTION VI**

### **GENERAL TERMS & CONDITIONS - ERECTION, TESTING & COMMISSIONING**

#### **1. DEFINITIONS and INTERPRETATION**

The following terms shall have the following meanings:

1.1 "Company": means BSES Rajdhani Power Ltd, a company incorporated under the Companies Act 1956 and having its office at BSES Bhawan, Nehru Place, New Delhi 110 019, which expression shall include its authorized representatives, agents, successors and assigns.

1.2 "Contractor": shall mean the successful Tenderer / vendor to whom the contract has been awarded

1.3 "Rate": The unit rates for the work to be carried out at site shall be as per finalized unit rates through tender. The finalized rates shall be firm for the entire duration of work to be carried out by the Contractor under the work order and are not subject to escalation for any reason whatsoever.

1.4. CONTRACT SPECIFICATION: The terms "CONTRACT Specification" shall mean the Technical specification of the work as agreed by you and description of work as detailed in Annexure-I enclosed herewith and all such particulars mentioned directly/referred to or implied as such in the contract.

1.5 SITE: The terms "Site" shall mean the working location in BRPL area. Under this tender, working location shall be as mentioned elsewhere.

1.6 ENGINEER IN CHARGE: "Engineer In-charge" means the Company's authorized representative for the purpose of carrying out the work.

#### **2. EXAMINATION OF SITE AND LOCAL CONDITIONS:**

The contractor is deemed to have visited the site of the work and ascertained therefore all site conditions and information pertaining to his work. The company shall not accept any claim whatsoever arising out of the difficult site/terrain/local conditions, if any.

#### **3. LANGUAGE AND MEASUREMENT:**

The CONTRACT issued to the contractor by the company and all correspondence and documents relating to the CONTRACT placed on the Contractor shall be written in English language.

Metric System shall be followed for all dimension, units etc.

#### **4. SCOPE OF WORK:**

The scope includes survey , design , engineering , manufacture , shop testing ,inspection , packing , dispatch , loading, unloading and storage at site, storage and construction insurance , assembly , erection ,structural , complete pre-commissioning checks , testing and commissioning at site , obtaining statutory clearance & certification from state electrical inspector and handing over to owner after successful laying of EHV & 11 kV Cable with required accessories & dismantling of existing circuits and installation of RMUs, Package Substations (PSS), etc as per BOQ ,with required accessories on single point responsibility basis. Schedule of work shall be as mentioned in the Bill of quantity attached herewith.

After completion of E/T/C work of the scheme, contractor has to obtain the Electrical Inspectorate's Clearance from the Electrical Inspector of Delhi Govt.

All the labour, cranes, tool and tackles, and technical supervision etc. are including in your scope of work. Adequate number of engineers, supervisors and laborers shall be posted at site and the list of the same along with certificate of Qualification of technical staff should be submitted by the Contractor to the Engineer In Charge for checking the adequacy immediately (with in seven days) after award of contract.

The Contractor shall also make his own arrangement for the accommodation/conveyance requirements for its staff at site. Company will be provided at site the adequate open space for contractor's site store for storing the materials, tools, tackles etc. The entire Contractor's storage will be within the site premises. All the incoming and outgoing materials, equipment, tools, tackles and any other items related to said work shall be entered into the register kept for this purpose and shall be in the custody of Contractor, however company does not hold any responsibility for any loss or damage of Contractor's material etc.

All loading/unloading, of materials at work-site shall be Bidder's responsibility. Involvement of Crane/Hydra/Tractor/Trailer for this type of work shall be in your scope. Adequate weather protection shall be provided by the contractor to keep the materials safe from sun & rain by providing covered storage space as well as using tarpaulins.

The contractor at his own shall arrange Water and Electricity Power at his cost.

**Special Instruction:-**

- a. Contractor need to conduct sheath voltage test after finishing the cable laying to check integrity of outer sheath in presence of project engineer(for 66kV only)
- b. EHV Cable should be tested as per the specification only. Contractor shall test the complete cable; BRPL will also witness the same.
- c. All cable laying tools and tackles and testing equipment shall be available with contractor in event of order.
- d. Contractor shall submit copy of cable laying schedule to BRPL in event of order so that quality checks can be done on sample basis.
- e. Penalty clause shall be incorporated in case any of workmen of contractor is found violating safety protocol as per BRPL WO.
- f. In case cable is damaged / fails during commissioning or during period of defect liability contractor shall bear all the repair and material cost.

Any additional work beyond the scope enumerated in the work order above shall be carried out as per the instructions of Engineer-In Charge. The company shall not entertain any claim or increase in the Work Order value due to execution of such additional work if the same is not approved by Engineer in Charge.

**5. RATES:**

The rates finalized for this order shall be firm for the entire duration of work carried out by the Contractor under the order and are not subject to any variation and escalation for any reason whatsoever.

The cost of insurance during loading/unloading of materials/ equipments during its storage and handling/erection at site for installation is included in the Bidder's scope and value shall be included in the unit rates finalized.

The unit rates finalized is also inclusive of barricading and watch & ward during execution and no separate charges shall be paid for the same.

The cost of training of BRPL Official shall be included in the prices quoted by vendor.

## **6. TAXES AND DUTIES:**

Prices are inclusive of all taxes and duties including GST as applicable. However, IT as per applicable rate will be deducted from your bills as Tax Deduction at Source (TDS).

The total order value shall remain **FIRM** within stipulated delivery period and shall not be adjusted on account of any price increase/variations in labour. However Statutory Taxes, duties and Levies imposed by Competent Authorities by way of fresh notification(s) within the stipulated delivery period shall be borne by BRPL on submission of necessary documents claiming such variation. The variation will be applicable only on such value wherever price breakup of same is submitted by vendor/available in PO/WO.

## **7. TERMS OF PAYMENT (Erection, Testing & Commissioning)**

Payment shall be made as under:

(i) 10% mobilization advance against submission of Advance Bank Guarantee of equivalent amount valid up to completion period/ handing over, whichever is earlier plus 3 months claim period. In case of delay, the BG shall be extended suitably.

ii) 75% prorata of total installation value shall be payable against R/A bills payable within 30 days after installation, testing & commissioning of material at site duly certified by Engineer in charge.

iii) 15% of contract value payable after completion of successful acceptance testing, commissioning and handing over of complete systems duly certified by Engineer in charge, submission of Electrical Inspector Clearance Certificate & submission of Performance Bank Guarantee of 10% of contract value valid up to defect liability period i.e. 24 months from the date of Handing over of entire Installation Plus 3 months towards Claim period.

All the Bank guarantees shall be submitted as per Company's format (Appendix I) and from any scheduled Bank approved by Company.

Company shall make payments of the bills either; By crossed cheque or by electronic transfer directly to Contractor's designated bank account.

## **8. Guarantee of Performance**

The bidder shall stand guarantee that the equipment and material supplied/service or work rendered under the contract is free from design, manufacturing, material, construction, erection & installation and workmanship & quality defects and is capable of its due, rated and intended quality performance, as an integrated product delivered under the contract for a specific period termed as Guarantee Period. The bidder should also guarantee that the equipment/material is new and unused except for the usage required for the tests and checks required as part of quality assurance.

**9. Guarantee period/Defect Liability period:**

The Guarantee Period will be equipment/service/work specific and shall be as specified in the Technical Specifications for the equipment/material/service/work and where Technical specifications are not part of contract documents or guarantee period is not specified in the Technical specifications, the guarantee period shall be as per the Special Terms and Conditions of the Contract. In case of no mention of the guarantee period in Technical specifications, Defect liability period will be 24 Months from the Date of Commissioning or 30 months from the date of delivery of final lot of supplies made, whichever is later.

For Cable & Joints, RMU and PSS: The defect liability period shall be 60 months from the date of commissioning or 66 months from the date of delivery whichever is later.

If during the defects liability period any materials / items are found to be defective, these shall be replaced or rectified by the bidder at his own cost within 30 days from the date of receipt of intimation.

**10. Performance Guarantee**

10.01 Bank guarantee shall be drawn in favour of "BSES Rajdhani Power Ltd" as applicable. The performance Bank guarantee shall be in the format as specified by BRPL.

10.02 Contract performance bank guarantee of total 10% of the contract price shall be submitted within 15 days of award of contract with the validity till completion of the contract period.

10.03 Contractor shall submit the performance bank guarantee equivalent to the 10% of the contract value at the time of claiming the last payment as per clause no. 7.0 (iii) (TERMS OF PAYMENT (Erection, Testing & Commissioning)), with the validity of the bank guarantee till Defect Liability Period i.e. 24 months from the date of Handing over of entire Installation plus 3 months.

**11. COMPLETION PERIOD**

You are required to mobilize your manpower and Tools & Tackles and furnish a list of equipments to be used for erection and commence the execution activity as per instructions of Engineer In-charge. The entire Erection, Testing & Commissioning work should be completed within 4 months from the date of issue of LOI/WO. The detailed schedule and milestone completion dates would be as per the contract schedules given from time to time by Engineer In-charge at site. You shall submit a weekly progress report to Engineer In charge.

**12. CLEANLINESS**

All debris shall be removed and disposed of at assigned areas on daily basis. Surplus excavated earth shall be disposed of in an approved manner. In short, you shall be fully responsible for keeping the work site clean at all times. In case of non-compliance, company shall get the same done at Contractor's risk and costs.

**13. COMMISSIONING & ACCEPTANCE TEST:**

After completion of the work, the Contractor shall conduct trial run/ operation in the presence of Engineer In charge. During such trial run the system shall be operated under the supervision of the Contractor. If any rectification/modification required during this period the Contractor shall do all necessary measures.

On satisfactory completion of above, the system shall be deemed to have energized and placed in commercial operation. The Engineer In Charge will issue an acceptance certificate.



**14. WORK COMPLETION CERTIFICATION, HANDING OVER.**

The work carried out by the Contractor under this order has to be certified by Engineer In-charge for satisfactory completion of work allotted to the contractor with respect to specifications / Field Quality Procedures as per applicable standards. In case of modification/correction to be carried out, contractor shall carry out the said modifications/correction without additional cost. The Contractor shall remain in close contact with Engineer In-Charge at site to report the general findings of the fieldwork during the initial as well as later stage of the work at site.

The contractor shall be solely responsible for any shortage or damage of materials issued to them handling of and / or in storage and erection at site and cost of the same will be recovered from the contractor as certified by Engineer In-Charge. Contractor must submit a periodical material reconciliation statement in the approval format with every Running Bill raise by him or end of every month whichever is earlier. The contractor shall maintain an accurate and exhaustive record detailing out the list of all items received by him for the purpose of erection and keep such record open for the inspection of the company.

**15. PENALTY AND LIQUIDATED DAMAGES**

14.1 Penalty: A penalty of 2.5% of bill amount shall be levied in each case of non-compliance of safety practices and site cleanliness.

14.2 Liquidated Damages: In the event of any delay in completion of the work beyond the stipulated time given by in order due to reasons solely attributable to the Contractor, the Contractor shall pay to the Company liquidated damages.

If the Contractor failed perform the services within the time period specified in the order, the Company shall, without prejudice to its other remedies under the contract, deduct liquidated damages a sum equivalent to 0.5 % of the order value for each week or part there of delay until the actual date of completion up to a maximum deduction of 10% of total order value. Once the maximum is reached to Company may consider termination of contract without any liabilities to Company.

Engineer In charge should specifically mention the amount of LD levied on the bill of contractor.

**16. SAFETY CODE:**

The Contractor shall ensure adequate safety precautions at site as required under the law of the land and shall be entirely responsible for the complete safety of their workman as well as other workers at site and premises. The contractor shall not deploy any worker below the age of 18 years.

The contractor shall observe the safety requirements as laid down in the contract and in case of sub-contract (only after written approval of company), it shall be the responsibility of main contractor that all safety requirements are followed by the employees and staff of the sub-contractor.

The contractor employing two hundred employees or more, including contract workers, shall have a safety coordinator in order to ensure the implementation of safety requirements of the contract and a contractor with lesser number of employees, including contract workers, shall nominate one of his employees to act as safety coordinator who shall liaise with the safety officer on matters relating to safety and his name shall be displayed on the notice board at a prominent place at the work site.

The contractor shall be responsible for non-compliance of the safety measures, implications, injuries, fatalities and compensation arising out of such situations or incidents.

In case of any accident, the contractor shall immediately submit a statement of the same to the owner and the safety officer, containing the details of the accident, any injury or casualties, extent of properly damage and remedial action taken to prevent recurrence and in addition, the contractor shall submit a monthly statement of the accidents to the owner at the end of each month.

**17. STATUTORY OBLIGATIONS:**

The Contractor shall take all steps as may be necessary to comply with the various applicable laws/rules including the provisions of contract labour (Regulation & Abolition Act) 1970 as amended, minimum wages Act, 1984, Workman Compensation Act, ESI Act, PF Act, Bonus Act and all other applicable laws and rules framed there under including any statutory approval required from the Central/State Govt. Ministry of Labour. Broadly, the compliance shall be as detailed below, but not limited to:

- a) An Electrical license issued by Govt.of Delhi.
- b) PF Code No. and all employees to have PF A/c No. under PF every Act, 1952.
- c) All employees to have a temporary or permanent ESI Card as per ESI Act.
- d) ESI Registration No.
- e) PAN No.
- f) Work Contract Tax Registration Number/ GSTN Registration.
- g) Labour License under Contract Labour Act (R & A) Act 1970

(The Contractor shall provide BRPL Engineer-in-charge a copy of Labour License responsible for execution of the job before start of the work.)

The Contractor must follow:

- a) Third party Insurance Policy before start of work.
- b) To follow Minimum Wages Act prevailing in the state.
- c) Salary / Wages to be distributed in presence of representative of Company's representative not later than 7th of each month.
- d) To maintain Wage- cum - Attendance Register.
- e) To maintain First Aid Box at Site.
- f) Latest P.F. and E.S.I. challans pertaining to the period in which work was undertaken along with a certificate mentioning that P.F. and E.S.I. applicable to all the employees has been deducted and deposited with the Authorities within the time limits specified under the respective Acts.
- g) Workman Compensation Policy. {If applicable}
- h) Labour license before start of work. {If applicable}

**18. WORKMAN COMPENSATION:**

The Contractor shall take insurance policy under the Workman Compensation Act to cover such workers who are not covered under ESI and PF by the Contractor however engaged to undertake the jobs covered under this order and a copy of this insurance policy will be given to Company for reference and records. This insurance policy shall be kept valid at all times. In case there are no worker involve other than those who are covered under ESI and PF by the Contractor, the Contractor shall certify for the same,

The contractor shall keep the company indemnified at all times, against all claims of compensation under the provision of Workmen Compensation Act 1923 and as amended from time to time or any compensation payable under any other law for the time being workman engaged by the contractor/sub-contractor/sub-agent in carrying out the job involved under this work order and against costs and expenses, if any, incurred by the company in connection therewith and without prejudice to make any recovery.

The company shall be entitled to deduct from any money due to or to become due to the Contractor, moneys paid or payable by way of compensation as aforesaid or cost or expenses in connection with any claims thereto and the Contractor shall abide by the decision of the Company as to the sum payable by the Contractor under the provisions of this clause.

## **19. STAFF AND WORKMAN**

It shall be responsibility of contractor

(a) To obtain Contract Labour License from the concerned authorities and maintain proper liaison with them. Necessary Forms for obtaining Labour License would be issued by the company. However you will bear all expenses for obtaining Labour license and registration in PF Department for your scope of work. You will deposit PF of your staff/laborer each month and all related documents should be furnished to us.

b) To obtain workman insurance cover against deployment of workers etc.

(II) To maintain, proper records relating to workmen employed, in the form of various Registers, namely,

- a) Register of workmen.
- b) Register of muster roll.
- c) Register of overtime.
- d) Register of wages.
- e) Any other register as per latest amendment Labour Act.

The records shall be in the prescribed formats only.

(III) To disburse monthly wages to your workers/ supervisors in time and in the presence of Company representatives or as directed by the Labour authorities.

(IV) To maintain proper liaison with the Project authorities, local police and all other government and local bodies.

(V) To pay your workmen at least not less than the minimum prescribed wages as per state/Central Labour laws as may be, applicable. The contractor shall, be responsible for compliance of all the provisions of minimum Wages Act, PF, ESIC Act workmen Compensation Act and Contract Labour Regulation & Abolition Act the rules made there under. In case of non-compliance of the statutory requirements. the company would take necessary action at the risk and cost of the Contractor.

(VI) To employ required number of skilled/semi-skilled and unskilled workmen as per site requirement to complete the entire project as per schedule. To provide safety shoes, safety helmets, safety belts, gloves etc. to your worker/staff as per requirement during erection work.

(VII) To employ necessary engineering and supervisory staff for completion of the Project in time. While day-to-day management of the site and supervision of the works shall be the responsibility of your Engineer - In charge, he will report to the Engineer in charge to assist him to discharge the overall responsibility of the execution of the project.

## **20. INSURANCE**

### **a) THIRD PARTY INSURANCE**

Before commencing the execution of the work the contractor shall take third party insurance policy at his own cost to insure against any damage or loss or injury which may occur to any property/public property or to NIT NO CMC/BR/20-21/SV/RS/KG/870

any person or any employee or representative of any outside Agency / the company engaged or not engaged for the work of the company, by or arising out of the execution of the work or temporary work or in carrying out of this Agreement. For third party insurance policies, the contractor shall be responsible for settlement of claims with the underwriters without any liability on the purchaser / owner and will arrange replacements / rectification expeditiously without awaiting settlement by insurance claim at contractors own cost.

**b) ACCIDENTAL INSURANCE POLICY FOR LIFE COVER:**

Before commencing the execution of the work, the CONTRACTOR shall take Accidental insurance policy for the staff engaged by him for this work to insure against any loss of life which may occur during the contract for the work of the COMPANY. The policy shall have coverage of Rs. 10 Lacs (Table C- Death + Permanent Total Disability + Partial permanent Disability due to external accidents). The Contractor shall be responsible for on the spot same day claim settlement with the victim's legal heirs without waiting for settlement by insurance claim without any liability on BRPL. The premium amount for such life cover policy shall be borne by the contractor. The contractor shall furnish copy of policy when demanded by BRPL.

**c) INSURANCE FOR MAN, MATERIAL & MACHINERY DEPLOYED AT SITE**

Contractor shall be responsible for the insurance for his own man, material and machinery deployed at site for the package awarded. Contractor shall furnish the copy of this insurance policy to the purchaser, prior start of work.

**21. SECURITY**

Adequate number of trained Security Guards shall be deployed both at the storage yard and stores as well as places of work to prevent theft and pilferage of material and accessories and various other materials. All security rules and safety rules enforced at site by company shall be strictly observed.

**22. ENVIRONMENTAL, HEALTH & SAFETY PLAN:**

Contractor will make ensure that the Environment, Health & Safety (EHS) requirements are clearly understood and faithfully implemented at all levels at site as per instruction of Company. Contractors must comply with these requirements:

- a) Comply with all of the elements of the EHS Plan and any regulations applicable to the work
- b) Comply with the procedures provided in the interests of Environment, Health and Safety
- c) Ensure that all of their employees designated to work are properly trained and competent
- d) Ensure that all plant and equipment they bring on to site has been inspected and serviced in accordance with legal requirement and manufacturer's or suppliers' instructions
- e) Make arrangements to ensure that all employees designated to work on or visit the site present themselves for site induction prior to commencement of work
- f) Provide details of any hazardous substances to be brought onsite
- g) Ensure that a responsible person accompanies any of their visitors to site

All contractors staff are accountable for the following:

1. Use the correct tools and equipment for the job and use safety equipment and protective clothing supplied, e.g. helmets, goggles, ear protection, etc. as instructed

2. Keep tools in good condition
3. Report to the Supervisor any unsafe or unhealthy condition or any defects in plant or equipment
4. Develop a concern for safety for themselves and for others
5. Prohibit horseplay
6. Not to operate any item of plant unless they have been specifically trained and are authorized to do so.

**23. TEST CERTIFICATE & QUALITY ASSURANCE:**

The Contractor shall procure all equipment from genuine sources as approved by the Company and as per Company specifications. The Contractor shall submit all the test certificates and joint inspection reports related to major equipment wherever applicable. The contractor shall ensure for the strict compliance to the specifications and Field Quality Procedures issued by company / Engineer in-charge.

**24. SUB-CONTRACTING / SUBLETTING:**

CONTRACTOR shall not assign or transfer the whole or any part of this Work Order or any other benefits accruing there from nor shall it subcontract / sublet the whole or any part of the Works without the prior written consent of COMPANY.

In the event the contractor assigns this work order, contractor's assignees shall be bound by the terms and conditions of this work order and shall , if deemed necessary by COMPANY at the time of such assignment, undertake in writing to be so bound by this Work Order.

Notwithstanding the subletting / subcontracting of any portion of the works, contractor shall remain wholly responsible for the carrying out, completion and satisfactory execution of Works in all respects in accordance with this Work Order, specification, approved drawings and data sheets.

**25. INDEMNITY:**

Contractor shall indemnify and save harmless COMPANY against and from any and all liabilities, claims, damages, losses or expenses arising due to or resulting from:

- a) any breach non-observance or non-performance by contractor or its employees or agents of any of the provisions of this Work Order.
- b) any act or omission of contractor or its employees or agents.
- c) any negligence or breach of duty on the part of contractor, its employees or agents including any wrongful use by it or them of any property or goods belonging to or by COMPANY.

Contractor shall at all times indemnify COMPANY against all liabilities to other persons, including he employees or agents of COMPANY or contractor for bodily injury, damage to property or other loss which may arise out of or in consequence of the execution or completion of Works and against all costs charges and expenses that may be occasioned to COMPANY by the claims of such person.

**26. EVENTS OF DEFAULTS:**

COMPANY may, without prejudice to any of its other rights or remedies under the Work Order or in law, terminate the whole or any part of this Work Order by giving written notice to the Contractor, if in the opinion of COMPANY, contractor has neglected to proceed with the works with due diligence or commits a breach of any of the provisions of this work order including but not limited to any of the following cases:

- a) Failing to complete execution of work within the terms specified in this work order.
- b) Failing to complete works in accordance with the approved schedule of works.
- c) Failing to meet requirements of specifications, drawings, and designs as approved by COMPANY.
- d) Failing to comply with any reasonable instructions or orders issued by COMPANY in connection with the works.

- e) Failing to comply with any of the terms or conditions of this work order.

In the event COMPANY terminates this work order, in whole or in part, on the occurrence of any event of default, COMPANY reserves the right to engage any other subcontractor or agency to complete the work or any part thereof, and in addition to any other right COMPANY may have under this work order or in law including without limitation the right to penalize for delay under clause 15.0 of this work order, the contractor shall be liable to COMPANY for any additional costs that may be incurred by COMPANY for the execution of the Work.

**27. RISK & COST:**

If the Contractor fails to execute the work as per specification / as per the direction of Engineer's In-charge within the scheduled period and even after the extended period, the contract shall get cancelled and company reserves the right to get the work executed from any other source at the Risk & Cost of the Contractor. The Extra Expenditure so incurred shall be debited to the Contractor.

**28. ARBITRATION:**

To the best of their ability, the parties hereto shall endeavor to resolve amicably between themselves all disputes arising in connection with this LOA. If the same remain unresolved within thirty (30) days of the matter being raised by either party, either party may refer the dispute for settlement by arbitration. The arbitration is to be undertaken by two arbitrators, one each to be appointed by either party. The arbitrators appointed by both the parties shall mutually nominate a person to act as presiding arbitrator before entering upon the reference in the event of a difference between the two arbitrators and the award of the said presiding arbitrator in such a contingency shall be conducted in accordance with the provisions of the Indian Arbitration & Conciliation Act, 1996 and the venue of such arbitration shall be in the city of New Delhi only.

**29. FORCE MAJEURE:****29.1 General:**

An "Event of Force Majeure" shall mean any event or circumstance not within the reasonable control, of the Party affected, but only if and to the extent that:

(i) Such event or circumstance, despite the exercise of reasonable diligence, could not have been prevented, avoided or reasonably foreseen by such Party;

(ii) Such event or circumstance materially and adversely affects the ability of the affected Party to perform its obligations under this Contract, and the affected Party has taken all reasonable precautions, due care and reasonable alternative measures in order to prevent or avoid the effect of such event on the affected parties ability to perform its obligations under this Contract and to mitigate the consequences thereof. For the avoidance of doubt, if such event or circumstance would not have materially and adversely affected the performance of the affected party had such affected party followed good industry practice, such event or circumstance shall not constitute force majeure.

(iii) Such event is not the direct or indirect result of the failure of such Party to perform any of its obligations under this Contract; and

(iv) Such Party has given the other Party prompt notice describing such events, the effect thereof and the actions being taken in order to comply with above clause

**29.2 Specific Events of Force Majeure:**

Subject to the provisions of above clause, Events of Force Majeure shall include only the following to the extent that they or their consequences satisfy the above requirements:

The following events and circumstances:

- a) Effect of any natural element or other acts of God, including but not limited to storm, flood, earthquake, lightning, cyclone, landslides or other natural disasters, and
- b) Explosions or fires
- c) Declaration of the Site as war zone.
- d) Any order, regulation, directive, requirement from any Governmental, legislative, executive or judicial authority.

#### 29.3 Notice of Events of Force Majeure

If a force majeure event prevents a party from performing any obligations under the Contract in part or in full, that party shall:

- (i) Immediately notify the other party in writing of the force majeure events within 2 working days of the occurrence of the force majeure event
- (ii) Be entitled to suspend performance of the obligation under the Contract which is affected by force majeure event for the duration of the force majeure event
- (iii) Use all reasonable efforts to resume full performance of the obligation as soon as practicable
- (iv) Keep the other party informed of all such efforts to resume full performance of the obligation on a regular basis
- (v) Provide prompt notice of the resumption of full performance or obligation to the other party.

#### 29.4 Mitigation of events of force majeure:

The Contractor shall:

- (i) Make all reasonable efforts to prevent and reduce to a minimum and mitigate the effect of any delay occasioned by an Event of Force Majeure, including applying other ways in which to perform the Contract;
- (ii) Use its best efforts to ensure resumption of normal performance after the termination of any Event of Force Majeure and shall perform its obligations to the maximum extent practicable as agreed between the Parties; and Keep the Company informed at regular intervals of the circumstances concerning the event of Force Majeure, with best estimates as to its likely continuation and what measures or contingency planning it is taking to mitigate and or terminate the Event of Force Majeure.

#### 29.5 Burden of proof:

In the event that the Parties are unable in good faith to agree that a Force Majeure event has occurred to an affected party, the parties shall resolve their dispute in accordance with the provisions of this Contract. The burden of proof as to whether or not a force majeure event has occurred shall be upon the party claiming that the force majeure event has occurred and that it is the affected party.

#### 29.6 Terminations for certain events of force majeure:

If any obligation of any Party under the Contract is or is reasonably expected to be delayed or prevented by a Force Majeure event for a continuous period of more than 1 (one) month during the Term of the Contract the Contract shall be terminated at the discretion of the Company and neither Party shall be liable to the other for any consequences arising on account of such termination.

**30. SECURITY CLAUSE:**

The technical information, drawing and other related documents forming part of work order and the information obtained during the course of investigation under this work order shall be the Company's executive property and shall not be used for any other purpose except for the execution of the work order. The technical information drawing, records and other document shall not be copied, transferred, or divulged and/ or disclosed to third party in full/part, not misused in any form whatsoever except to the extent for the execution of this work order.

This technical information, drawing and other related documents shall be returned to the Company with all approved copies and duplicates including drawing/plans as are prepared by the Contractor during the executions of this work order, if any, immediately after they have been used for agreed purpose.

In the event of any breach of this provision, the contractor shall indemnify the Company against any loss, cost or damage or claim by any party in respect of such breach.

**31. TERMINATION**

"During the course of the execution, if at any time BRPL observe and form an opinion that the work under the order is not being performed in accordance with the terms of this Agreement, BRPL reserves its right to cancel this Agreement giving 15 days notice mentioning the reason for the termination of the agreement and BRPL will recover all damages including losses occurred due to loss of time from Contractor.

**31. QUALITY**

Contractor shall ensure that strict quality is maintained and execution of works under the Work Order and Works are executed in conformity with the Specification.

All tools, tackles, instruments and other equipments used in the execution of the Works shall be duly calibrated as required and Contractor shall maintain proper records of such tools, tackles, instruments and / or equipment.

**32. ACCEPTANCE**

Acceptance of the work order implies and includes acceptance of all terms and conditions enumerated in this work order in the technical specification and drawings made available to you consisting of general conditions, detailed scope of work, detailed technical specification & detailed equipment, drawing. Complete scope of work and the Contractor's and Company's contractual obligation are strictly limited to the terms set out in the work order. No amendments to the concluded work order shall be binding unless agreed to in writing for such amendment by both the parties.

However, during the course of the execution of the work order, if at any time the Company's representative observe and form an opinion that the work under the work order is not being performed in accordance with the terms of this work order, the company reserves its right to cancel this work order forthwith without assigning any reason and the Company will recover all damages including losses occurred due to loss of time from the Contractor.

We request you to please sign the duplicate copy of the work order as a token of your acceptance and return to us.



**SECTION VII****PRICE FORMAT – ERECTION, TESTING & COMMISSIONING****Part I**

Project	Shifting/Relocation of 33kV feeders (IP to Kilokari Bay no. 1 & 3) and 33kV O/H D/C line Bay 25 & 37 at Sarai Kale khan_ NCRTC						
Sr. No.	B. Service_Item Discriptions	Unit	Quantity	Basic (Rs)	GST(Rs)	Unit Landed (Rs)	Total Landed Cost (Rs)
1	Transportation of various electrical equipment / material from various BRPL / BYPL Store / any site to the site of work in the Union Territory of Delhi including loading and unloading at both ends manually / by using suitable T&P for safe loading/ unloading.The material transported at site should be placed inyard where ever required. by Manually.	TRP	15				
2	Transportation of various electrical equipment / material from various BRPL / BYPL Store / any site to the site of work in the Union Territory of Delhi including loading and unloading at both ends manually / by using suitable T&P for safe loading/ unloading.The material transported at site should be placed inyard where ever required. by Using Crane.	TRP	15				
3	Transportation of Empty cable drum from site to site or from site to store any	TRP	0				

	where in Union territory of Delhi.						
4	Digging of cable trench as per specification and drawings. Rate is inclusive of digging and backfilling. Measurement shall be as per actual depth excavated . For Ordinary Bituminous	CUM	495				
5	Digging of cable trench as per specification and drawings. Rate is inclusive of digging and backfilling. Measurement shall be as per actual depth excavated . For Dense Carpeted bituminous Road.	CUM	840				
6	Digging of joint pit suitable for 33/66 KV cable joint box and covering the joint box with sand and providing protection as per BYPL/BRPL design. For Ordinary bituminous road	CUM	234				
7	Digging of joint pit suitable for 33/66 KV cable joint box and covering the joint box with sand and providing protection as per BYPL/BRPL design. Dence carpet	CUM	324				
8	Digging of test pits of requiried size( not lessthan 1/2 Mtr. Wide at site for identification of cable route). Relevent volume shall be deducted from quantities of same item of item No. 3. for Ordinary bituminous road	EA	18				
9	Digging of test pits of requiried size( not lessthan 1/2 Mtr. Wide at site for identification of cable route). Relevent volume shall be deducted from quantities of same item of cable digging For Dense carpeted bituminous road / CC Road	EA	32				

10	Removal of Malba including Loading / Unloading on own vehicle. The payment shall be restricted to the quantity of sand laid.	CUM	538				
11	Laying of under ground cable in trench, supply and fixing of cable identification tags (9" X 4") at every 30 Mtrs, refilling the trench and ramming the surface, including watch and ward till charging of cable ( This activity includes only labour jobs ) for 33 KV three core cable Running Mtr	M	9200				
12	Providing 1:2:4 concrete including supply of all required materials, labour curing etc. complete.	CUM	10				
13	Charges for providing continous steel barricade including cost of all material plant consumables transport and labour for shifting placing painting and regular maintenance. As per new specification.	M	2300				
14	Charges of making 33kv, 3x400SQ MM Straight through joints	EA	62				
15	Laying Sand Cushioning for cable route as per BRPL/BYPL specification,Sand cushion will be min 75mm below and 75mm above the cable, (scope covers including supply of sand)	CUM	409				
16	Installation of Warning Tape as per the Specification of BRPL/BYPL	M	1780				
17	Installation of RCC Cable Cover	EA	2846				
18	Survey and submission of Ground penetration report for entire Route.	M	2300				
19	Charges for carrying out Route survey and identification of underground utilities of various civic agencies	M	9200				

	before/ during execution of scheme involving cable laying work. Route length will be considered for payment. Route length will be specifically verified by DGM.						
20	Laying of HDPE pipe of 180mm dia.of PN6 Class PE80 For crossing of roads by trenchless technology including required equipment, manpower & transport of equipment from one place to another.	M	3240				
21	Crossing of roads by trenchless technology by laying of HDPE pipe excluding supply of pipe .Laying by Pneumatic Jack Hammer Road Cutting.laying . 180mm dia.	M	2400				
22	Charges for Hi pot test - Testing equipment to be provided by the contractor. For 33 KV cables	EA	8				
23	Fixing of RCC Coffin for joint as per the specification of BRPL/BYPL(sand required for filling of coffin is in bidder scope)	EA	62				
24	Installation, testing and commissioning of RFID active Electronic ball markers (for 33kV and 66kV joint)	EA	62				
25	Installation, testing and commissioning of RFID passive Electronic ball markers (for 33kV and 66kV joint)	EA	62				
26	Laying of 8" O.D. GI pipe for crossing small Nallas in the cable route.	M	144				

27	<p>Dismantling of ACSR GOAT Conductor, Earthwire, Insulator &amp; Hardware Fittings i.e. Single Tension String Insulator fittings with single tension clamp for single GOAT conductor ,Single Tension String Insulator fittings with double tension clamp for twin GOAT conductor, Double Tension String Insulator fittings with single tension clamp for single GOAT conductor, Single Suspension String Insulator fittings with single drop/tension clamp for single GOAT conductor, Single Suspension String Insulator fittings with double drop/tension clamp for twin GOAT conductor, Single Suspension String Insulator fittings with single suspension clamp for single GOAT conductor, Single Suspension String Insulator fittings with double suspension clamp for twin GOAT conductor , Bolted type 'T' Connector suitable for single GOAT conductor, Vibration Damper for GOAT Conductor, Repair Sleeve for GOAT, Mid span compression joint for ACSR GOAT, Rigid Type Spacers for twin GOAT PER CIRCUIT INCLUDING EARTH WIRE( PER CIRCUIT MEANS 3 CONDUCTORS AND ONE EARTH WIRE INCLUDING HARDWARE FITTINGS AND ACCESSORIES)</p>	KM	2.2				
28	<p>Dismantling MS structure for different equipment cable supporting structure including supply of nuts and bolts, consumables ,</p>	MT	25				

	welding electrode, hacksaw blades etc.						
29	Fixing of Cable Route/Joint Marker as per approved drawing.For 33/66 KV cables.	Nos	62				

## Part II

Project	NCRTC_ Sarai Kale Khan Shifting_11kV Feeder						
Sr No	B. Service _Item Descriptions	UOM	Qty	Basic (Rs)	GST (Rs)	Unit Landed (Rs)	Total Landed Cost (Rs)
1	Transportation of material by hand-cart	TRP	15				
2	Transportation of Electrical equipments or any any kind of materials from store to site or from site to site including laoding and unloading at both ends by manually -> By Half body Truck. Note:- Above tem will be selected ensuring optimum utilization of the approved rates.	TRP	3				
3	Transportation of material by trailor including loading and un-loading	TRP	1				
4	Transportation of Electrical equipments or any any kind of materials from store to site or from site to site including laoding and unloading at both ends by using T & P such as Tripod/cranes -> By Full body truck load (9T capacity). Note:- Above item will be selected ensuring optimum utilization of the approved rates.	TRP	13				
5	Transportation of empty cable drum from site to designated store anywhere in Delhi.For Steel Drum	EA	2				
6	RMU installation 3- Function	EA	1				
7	Testing and commissioning comprising of Hi-pot test, primary injection, IR & mV Drop test for 3-Function RMU.	EA	1				
8	Making Straight through Joint	EA	26				
9	Making Cable End	EA	19				

10	Labour charges for digging of the trench of the required size including the backfilling with the excavated earth ramming the same and disposing the surplus excavated material all complete. Payment shall be released as per actual depth excavated or as mentioned in drawing whichever is less. Digging of cable trench in Dense carpeted bituminous roads/CC Road/Asphaltic Road for 1.1KV LT 3.5X300 sq.mm Single /Double / Triple circuit of size 400X875 mm as per Drg.# 8,Type A-1.	M	175				
11	Laying of under- ground LT cable in trench ,docketing with bricks & sand as per BSES specifications, refilling the trench and ramming the surface & removal of malba if any, including supply of IInd class bricks and sand (Sand cushion min 65mm below and 75mm above the cable. Also a warning tape above 224mm of the docket be laid ) and including watch and ward till charging of cable of size 3.5X300 sq.mm.Single Circuit,as per Drg.# 8,Type A-1.	M	175				
12	Labour charges for digging of the trench of the required size including the backfilling with the excavated earth ramming the same and disposing the surplus excavated material all complete. Payment shall be released as per actual depth excavated or as mentioned in drawing whichever is less. Digging of cable trench in Dense carpeted bituminous roads/CC Road/Asphaltic Road for 1.1KV LT 3.5X150 sq.mm Single /Double / Triple circuit of size 400X875 mm as per Drg.# 9,Type A-1.	M	150				
13	Laying of under- ground LT cable in trench ,docketing with bricks & sand as per BSES specifications, refilling the trench and ramming the surface & removal of malba if any, including supply of IInd class bricks and sand (Sand cushion min 75mm below and 80mm above the cable. Also a warning tape above 300mm of the docket be laid ) and including watch and ward till charging of cable of size 3.5X150 sq.mm.Single Circuit,as per Drg.# 9,Type A-1.	M	150				
14	Mounting of LT cables on pole,after passing through suitable size of GI pipe proper Clamping and proving and fixing wooden bush alongwith clamping of end box. Above Of size 150 sqmm /pole.(The length of cable to be mounted on pole should be excluded from the laying length.)	M	50				
15	Laying of LT cable of following size in S/ Stn. Trench.above 150 sq.mm.	M	75				

16	Labour charges for digging of the trench of the required size including the backfilling with the excavated earth and ramming the same and disposing the surplus excavated material all complete. Payment shall be released as per actual depth excavated or as mentioned in drawing whichever is less. Digging of cable trench in Dense carpeted bituminous roads/CC Road/Asphaltic Road for 11KV H.T. 3X150/300 sq.mm Single Circuit of size 400X1055 mm as per Drg.# 6 and Type A-2.	M	600				
17	Labour charges for digging of the trench of the required size including the backfilling with the excavated earth and ramming the same and disposing the surplus excavated material all complete. Payment shall be released as per actual depth excavated or as mentioned in drawing whichever is less. Digging of Cable trench in ordinary soil for 11KV H.T. 3X150/300 sq mm Single Circuit of size 400X1055 mm as per Drg.# 6, TYPE A-2.	M	700				
18	Laying of under- ground HT. cable in trench ,docketing with bricks & sand as per BSES specifications, refilling the trench and ramming the surface & removal of malba if any, including supply of IInd class bricks and sand (Sand cushion min 75mm below and 75mm above the cable. Also a warning tape above 224 mm of the docket be laid.) and including watch and ward till charging of cable of size 3X150/300 sq.mm. 11KV. Single Circuit, as per Drg.#6, Type A-2.	M	1300				
19	Laying of HT cable of following size in S/ Stn. Trench. above 150 sq.mm.	M	50				
20	Crossing of roads by trench-less technology by laying of HDPE pipe excluding supply of pipe. Laying by HDD Machine Molding. Drilling and laying. 160mm dia.	M	2050				
21	Laying of HT cables through GI Pipe /RCC hume pipe/HDPE Pipe. above 150 sqmm upto 300 sqmm.	M	2050				
22	Plinthing and erection of Service Pillars / Feeder Pillars as per BSES design including supply of bricks, cement, badarpur, jamuna sand etc. Feeder Pillar	EA	2				
23	Installation of fire buckets filled with sand, including fabrication of frame/stand of suitable size, canopy, grouting on surface or wall, painting of frame including necessary hardware and consumables. 4 bucket stand	SET	1				



24	Fabrication work using MS steel ( for any type & as per drawing, specification provided by BSES ) including all consumables i.e. welding rods, supplying and providing 2 coats of red oxide primer and one coat of aluminum paint, nuts, bolts and washers. All type frames,structure,clamps etc.Steel shall be provided by Contactor.	KG	200				
25	Installation of any hardware fitting on GI pipe for supporting service line/LT main (excluding fabrication works but including jumpering etc.).Rate is for per GI Pipe.	EA	10				
26	Painting of nomenclature of size(s) as reqd. on FP/Service Pillar / LT Panel / HT Panel and LT ACBs etc. including supply of paint. Rates are per alphabet	EA	200				
27	Optional price for Continuous Steel Barricading of 1.2 M High including cost of all materials.40% quantity for selected location per meter Trench	M	600				
28	High Voltage test of 11KV 3x300sq.mm cable - Testing Equipment to be provided by the contractor.	EA	3				
29	Term.of LT Cbils to MCCB w/o supply	EA	3.00				
30	Inst. 11/.433KV Tranf 1000KVA	EA	1.00				
31	Inst. HT11KV 350MVA RMU-3Funct.	EA	1.00				
32	Testing & Comm. RMU 3Function	EA	1.00				
33	Inst. LT Bd for 990KVA Tranf	EA	1.00				
34	Civil Works	LS	1				

**Appendix-X****COMMERCIAL TERMS AND CONDITIONS – E/T/C**

SI No	Item Description	AS PER BRPL	BIDDER'S CONFIRMATION
1	Validity	120 days from the due date of submission or amended due date of submission	
2	Price basis	<b>Firm.</b> Prices shall be inclusive of all taxes & duties.	
3	Payment terms	<p>a) 10% mobilization advance against submission of Advance Bank Guarantee of equivalent amount valid upto completion period/ handing over, whichever is earlier plus 3 months claim period. In case of delay, the BG shall be extended suitably.</p> <p>b) 75% prorata of total installation value shall be payable against R/A bills payable within 30 days after installation, testing &amp; commissioning of material at site duly certified by Engineer in charge.</p> <p>c) 15% of contract value payable after completion of successful acceptance testing, commissioning and handing over of complete systems duly certified by Engineer in charge, submission of Electrical Inspector Clearance Certificate &amp; submission of Bank Guarantee of 10% of contract value valid up to defect liability period i.e. 24 months from the date of Handing over of entire Installation Plus 3 months towards Claim period.</p>	
4	Completion time	4 months from date of LOI/Order	
5	Defect Liability period	24 months from the date of Handing over of entire Installation. For Cable & Joints, PSS and RMU: The defect liability period shall be 60 months from the date of commissioning or 66 months from the date of delivery whichever is earlier.	
6	Liquidated damages	0.5 % of the order value for each week or part there of delay until the actual date of completion up to a maximum deduction of 10% of total order value	
7	Contract Performance Bank Guarantee	10% (Ten percent) of the Contract Price valid up to completion period/handing over.	
8	Performance Bank Guarantee	10% (Ten percent) of the Contract Price valid up to Defect Liability Period i.e. 24 months from the date of Handing over of entire Installation plus 3 months towards claim period.	

**APPENDIX-XI**  
**FORMAT FOR PERFORMANCE BANK GUARANTEE**

(TO BE ISSUED ON RS 100/- STAMP PAPER)

Bank Guarantee No.

Place:

Date:

To  
BSES Rajdhani Power Limited

Whereas BSES RAJDHANI POWER LTD (hereinafter referred to as the "Purchaser", which expression shall unless repugnant to the context or meaning thereof include its successors, administrators and assigns) has awarded to M/s. \_\_\_\_\_ with its Registered/ Head Office at \_\_\_\_\_

(Hereinafter referred to as the "Supplier" which expression shall unless repugnant to the context or meaning thereof, include its successors administrators, executors and assigns), a contract no. \_\_\_\_\_ Dated \_\_\_\_\_ (the Contract);

And whereas the value of the Contract is Rs. \_\_\_\_\_ (The Contract Value).

And whereas it is a condition of the Contract that the Supplier shall provide a Performance Bank Guarantee for the due and faithful performance of the entire Contract for a sum equivalent to - % of the Contract Value to the Purchaser on or before \_\_\_\_\_

And whereas the Bank under instructions from the Supplier has agreed to guarantee the due performance of the Contract.

Now it is agreed as follows:

1. we \_\_\_\_\_ (Name of the Bank) having its Head Office at \_\_\_\_\_ (hereinafter referred to as the Bank, which expression shall unless repugnant to the context or meaning thereof, include its successors, administrators, executors and assigns) shall indemnify and keep indemnified the Purchaser for, and guarantee and undertake to pay to the Purchaser immediately on written demand, a sum equivalent to % of the Contract Value

as aforesaid at any time upto \_\_\_\_\_ (day/month/year) without any demur, reservation, contest, recourse or protest and/or without any reference to the Supplier, against all losses, damages, costs and expenses that may be caused to or suffered by the Purchaser by reason of any default on the part of the Supplier in performing and observing any and all the terms and conditions of the Contract or breach on the part of the Supplier of terms or conditions of the Contract.

2. The demand shall consist only of an original letter issued by Purchaser stating that the Supplier has failed to fulfill its obligations under the Contract. Such demand made by the Purchaser on the Bank shall be conclusive and binding notwithstanding any difference or dispute between the Purchaser and the Supplier or any difference or dispute pending before any Court, Tribunal, Arbitrator or any other authority.

3. The Bank undertakes not to revoke this guarantee during its currency without previous written consent of the Purchaser and further agrees that the guarantee herein contained shall continue to be enforceable during the period that would be taken for satisfactory performance and fulfillment in all respects of the Contract or in the event of any dispute between the Purchaser and Supplier until the dispute is settled (provided that the claim/ demand under this guarantee is \_\_\_\_\_)

lodged /referred during the currency of this guarantee) or till the Purchaser discharges this guarantee whichever is earlier.

4. The Purchaser shall have the fullest liberty without affecting in any way the liability of the Bank under this guarantee from time to time to extend the time for performance of the Contract by the Supplier. The Purchaser shall have the fullest liberty, without affecting the liability of the Bank under this guarantee, to postpone from time to time the exercise of any powers vested in them or of any right which they might have against the Supplier, and to exercise the same at any time in any manner, and either to enforce or to forbear to enforce any covenants, contained or implied, in the Contract. or any other course or remedy or security available to the Purchaser. The Bank shall not be released of its obligations under these presents by any exercise by the Purchaser of its liberty with reference: to the matters aforesaid or any of them or by reason of any other act or forbearance or other acts of omission or commission on the part of the Purchaser or any other indulgence shown by the Purchaser of by any other matter or thing whatsoever which under law would, but for this provision, have the effect of relieving the Bank.

5. The Bank agrees that the Purchaser and its option shall be entitled to enforce this guarantee against the Bank as a principal debtor, in the first instance without proceeding against the Supplier and notwithstanding any security or other guarantee that the Purchaser may have in relation to the Supplier's liabilities.

6. Notwithstanding anything contained hereinabove the liability of the Bank under this guarantee is restricted to a sum equivalent to % of the Contract Value ie. Rs.(Rupees) and it shall remain in force upto and including .Unless a demand to enforce a claim under this guarantee is made against the Bank within 3 months from the the above date of expiry i.e. up to all the rights of the Purchaser under the said guarantee shall be forfeited and the Bank shall be released and discharged from all liabilities thereafter.

7. This Performance Bank Guarantee shall be governed by the laws of India.

Dated this Witness

day of 20..... at

1. For Bank

2. Signature Name Power of Attorney No:

Banker's Seal

**SECTION VIII****GRAND SUMMARY OF THE QUOTED PRICE**

Sr. Nos.	SCHEME DESCRIPTION	Total price for supply F.O.R site inclusive all duties taxes	Total for Erection, Testing & Commissioning inclusive all Taxes(INR)	Grand Total(INR)
1	<b>A.</b> Shifting /Relocation of 33kV feeders (IP to Kilokari Bay no. 1 & 3) and 33kV O/H D/C line Bay 25 & 37 at Sarai Kale khan_ NCRTC			
2	<b>B.</b> Shifting of BSES Services up to 11 kV infringing right of way for the construction of Delhi-Ghaziabad-Meerut Regional Rapid Transit System (RRTS) Corridor near Sarai Kale Khan area NCRTC			
<b>TOTAL Package Cost</b>				
<b>In words :</b>				

We declare that the following are our quoted prices in INR for the entire project/schemes.

Date:

Bidder Name:

Place:

Bidders Address:

Name & Signature .....

Designation: .....

Common Seal:.....

## **SECTION IX**

### **VENDOR CODE OF CONDUCT**

Bidder shall agree to comply with Vendor code of Conduct as mentioned in BRPL Website. Purchaser is committed to conducting its business in an ethical, legal and socially responsible manner. To encourage compliance with all legal requirements and ethical business practices, Purchaser has established this Vendor Code of Conduct (the "Code") for Purchaser's Vendors. For the purposes of this document, "Vendor" means any company, corporation or other entity that sells, or seeks to sell goods or services, to Purchaser, including the Vendor's employees, agents and other representatives. Fundamental to adopting the Code is the understanding that a business, in all of its activities, must operate in full compliance with the laws, rules and regulations of the countries in which it operates. This Code encourages Vendors to go beyond legal compliance, drawing upon internationally recognized standards, in order to advance social and environmental responsibility.

#### **I. Labour and Human Rights**

Vendors must uphold the human rights of workers, and treat them with dignity and respect as understood by the international community.

- Fair Treatment - Vendors must be committed to a workplace free of harassment. Vendors shall not threaten workers with or subject them to harsh or inhumane treatment, including sexual harassment, sexual abuse, corporal punishment, mental coercion, physical coercion, verbal abuse or unreasonable restrictions on entering or exiting company provided facilities.
- Antidiscrimination - Vendors shall not discriminate against any worker based on race, colour, age, gender, sexual orientation, ethnicity, disability, religion, political affiliation, union membership, national origin, or marital status in hiring and employment practices such as applications for employment, promotions, rewards, access to training, job assignments, wages, benefits, discipline, and termination. Vendors shall not require a pregnancy test or discriminate against pregnant workers except where required by applicable laws or regulations or prudent for workplace safety. In addition, Vendors shall not require workers or potential workers to undergo medical tests that could be used in a discriminatory way except where required by applicable law or regulation or prudent for workplace safety.
- Freely Chosen Employment - Forced, bonded or indentured labour or involuntary prison labour is not to be used. All work will be voluntary, and workers should be free to leave upon reasonable notice.

Workers shall not be required to hand over government-issued identification, passports or work permits as a condition of employment.

- Prevention of Under Age Labour - Child labour is strictly prohibited. Vendors shall not employ children. The minimum age for employment or work shall be 15 years of age, the minimum age for employment in that country, or the age for completing compulsory education in that country, whichever is higher. This Code does not prohibit participation in legitimate workplace apprenticeship programs that are consistent with Article 6 of ILO Minimum Age Convention No. 138 or light work consistent with Article 7 of ILO Minimum Age Convention No. 138.
- Juvenile Labour - Vendors may employ juveniles who are older than the applicable legal minimum age for employment but are younger than 18 years of age, provided they do not perform work likely to jeopardize their health, safety, or morals, consistent with ILO Minimum Age Convention No. 138.
- Minimum Wages - Compensation paid to workers shall comply with all applicable wage laws, including those relating to minimum wages, overtime hours and legally mandated benefits. Any disciplinary wage deductions are to conform to local law. The basis on which workers are being paid is to be clearly conveyed to them in a timely manner.
- Working Hours - Studies of good manufacturing practices clearly link worker strain to reduced productivity, increased turnover and increased injury and illness. Work weeks are not to exceed the maximum set by local law. Further, a work week should not be more than 60 hours per week, including overtime, except in emergency or unusual situations. Workers should be allowed at least one day off per seven-day week.
- Freedom of Association - Open communication and direct engagement between workers and management are the most effective ways to resolve workplace and compensation issues. Vendors are to respect the rights of workers to associate freely and to communicate openly with management regarding working conditions without fear of reprisal, intimidation or harassment. Workers' rights to join labour unions, seek representation and or join worker's councils in accordance with local laws should be acknowledged.

II. Health and Safety Vendors must recognize that in addition to minimizing the incidence of work-related injury and illness, a safe and healthy work environment enhances the quality of products and services, consistency of production and worker retention and morale. Vendors must also recognize that ongoing worker input and education is essential to identifying and solving health and safety issues in the workplace.

The health and safety standards are:

- Occupational Injury and Illness - Procedures and systems are to be in place to prevent, manage, track and report occupational injury and illness, including provisions to: a) encourage worker reporting; b) classify and record injury and illness cases; c) provide necessary medical treatment;

- d) investigate cases and implement corrective actions to eliminate their causes; and e) facilitate return of workers to work.
- Emergency Preparedness - Emergency situations and events are to be identified and assessed, and their impact minimized by implementing emergency plans and response procedures, including: emergency reporting, employee notification and evacuation procedures, worker training and drills, appropriate fire detection and suppression equipment, adequate exit facilities and recovery plans.
  - Occupational Safety - Worker exposure to potential safety hazards (e.g., electrical and other energy sources, fire, vehicles, and fall hazards) are to be controlled through proper design, engineering and administrative controls, preventative maintenance and safe work procedures (including lockout/tagout), and ongoing safety training. Where hazards cannot be adequately controlled by these means, workers are to be provided with appropriate, well-maintained, personal protective equipment. Workers shall not be disciplined for raising safety concerns.
  - Machine Safeguarding - Production and other machinery is to be evaluated for safety hazards. Physical guards, interlocks and barriers are to be provided and properly maintained where machinery presents an injury hazard to workers.
  - Industrial Hygiene - Worker exposure to chemical, biological and physical agents is to be identified, evaluated, and controlled. Engineering or administrative controls must be used to control overexposures. When hazards cannot be adequately controlled by such means, worker health is to be protected by appropriate personal protective equipment programs.
  - Sanitation, Food, and Housing - Workers are to be provided with ready access to clean toilet facilities, potable water and sanitary food preparation, storage, and eating facilities. Worker dormitories provided by the Participant or a labour agent are to be maintained clean and safe, and provided with appropriate emergency egress, hot water for bathing and showering, and adequate heat and ventilation and reasonable personal space along with reasonable entry and exit privileges.
  - Physically Demanding Work - Worker exposure to the hazards of physically demanding tasks, including manual material handling and heavy or repetitive lifting, prolonged standing and highly repetitive or forceful assembly tasks is to be identified, evaluated and controlled.

### III. Environmental

Vendors should recognize that environmental responsibility is integral to producing world class products. In manufacturing operations, adverse effects on the environment and natural resources are to be minimized while safeguarding the health and safety of the public.

The environmental standards are:

- Product Content Restrictions - Vendors are to adhere to applicable laws and regulations regarding prohibition or restriction of specific substances including labeling laws and regulations for recycling



and disposal. In addition, Vendors are to adhere to all environmental requirements specified by Purchaser.

- Chemical and Hazardous Materials -Chemical and other materials posing a hazard if released to the environment are to be identified and managed to ensure their safe handling, movement, storage, recycling or reuse and disposal.
- Air Emissions - Air emissions of volatile organic chemicals, aerosols, corrosives, particulates, ozone depleting chemicals and combustion by-products generated from operations are to be characterized, monitored, controlled and treated as required prior to discharge.
- Pollution Prevention and Resource Reduction -Waste of all types, including water and energy, are to be reduced or eliminated at the source or by practices such as modifying production, maintenance and facility processes, materials substitution, conservation, recycling and re-using materials.
- Wastewater and Solid Waste - Wastewater and solid waste generated from operations, industrial processes and sanitation facilities are to be monitored, controlled and treated as required prior to discharge or disposal.
- Environmental Permits and Reporting - All required environmental permits (e.g. discharge monitoring) and registrations are to be obtained, maintained and kept current and their operational and reporting requirements are to be followed.

#### IV. Ethics

Vendors must be committed to the highest standards of ethical conduct when dealing with workers, Vendors, and customers.

- Corruption, Extortion, or Embezzlement - Corruption, extortion, and embezzlement, in any form, are strictly prohibited. Vendors shall not engage in corruption, extortion or embezzlement in any form and violations of this prohibition may result in immediate termination as an Vendor and in legal action.
- Disclosure of Information - Vendors must disclose information regarding its business activities, structure, financial situation, and performance in accordance with applicable laws and regulations and prevailing industry practices.
- No Improper Advantage - Vendors shall not offer or accept bribes or other means of obtaining undue or improper advantage.
- Fair Business, Advertising, and Competition - Vendors must uphold fair business standards in advertising, sales, and competition.
- Business Integrity - The highest standards of integrity are to be expected in all business interactions. Participants shall prohibit any and all forms of corruption, extortion and embezzlement. Monitoring and enforcement procedures shall be implemented to ensure conformance.

- Community Engagement - Vendors are encouraged to engage the community to help foster social and economic development and to contribute to the sustainability of the communities in which they operate.
- Protection of Intellectual Property - Vendors must respect intellectual property rights; safeguard customer information; and transfer of technology and know-how must be done in a manner that protects intellectual property rights.

#### V. Management System

Vendors shall adopt or establish a management system whose scope is related to the content of this Code. The management system shall be designed to ensure (a) compliance with applicable laws, regulations and customer requirements related to the Vendors' operations and products; (b) conformance with this Code; and (c) identification and mitigation of operational risks related to this Code. It should also facilitate continual improvement.

The management system should contain the following elements:

- Company Commitment - Corporate social and environmental responsibility statements affirming Vendor's commitment to compliance and continual improvement.
- Management Accountability and Responsibility - Clearly identified company representative[s] responsible for ensuring implementation and periodic review of the status of the management systems.
- Legal and Customer Requirements - Identification, monitoring and understanding of applicable laws, regulations and customer requirements.
- Risk Assessment and Risk Management - Process to identify the environmental, health and safety and labour practice risks associated with Vendor's operations. Determination of the relative significance for each risk and implementation of appropriate procedural and physical controls to ensure regulatory compliance to control the identified risks.
- Performance Objectives with Implementation Plan and Measures - Areas to be included in a risk assessment for health and safety are warehouse and storage facilities, plant/facilities support equipment, laboratories and test areas, sanitation facilities (bathrooms), kitchen/cafeteria and worker housing /dormitories. Written standards, performance objectives, targets and implementation plans including a periodic assessment of Vendor's performance against those objectives.
- Training - Programs for training managers and workers to implement Vendor's policies, procedures and improvement objectives.
- Communication - Process for communicating clear and accurate information about Vendor's performance, practices and expectations to workers, Vendors and customers.

- Worker Feedback and Participation - Ongoing processes to assess employees' understanding of and obtain feedback on practices and conditions covered by this Code and to foster continuous improvement.
- Audits and Assessments - Periodic self-evaluations to ensure conformity to legal and regulatory requirements, the content of the Code and customer contractual requirements related to social and environmental responsibility.
- Corrective Action Process - Process for timely correction of deficiencies identified by internal or external assessments, inspections, investigations and reviews.
- Documentation and Records - Creation of documents and records to ensure regulatory compliance and conformity to company requirements along with appropriate confidentiality to protect privacy.

The Code is modelled on and contains language from the Recognized standards such as International Labour Organization Standards (ILO), Universal Declaration of Human Rights (UDHR), United Nations Convention against Corruption, and the Ethical Trading Initiative (ETI) were used as references in preparing this Code and may be useful sources of additional information.

## ANNEXURE –I

The Contractor must submit the following to Engineer-In-Charge before commencement of work:

- a) An Electrical license. (If applicable)
- b) PF Code No. and all employees to have PF A/c No. under PF every Act, 1952.
- c) All employees to have a temporary or permanent ESI Card as per ESI Act.
- d) ESI Registration No.
- e) PAN No.
- f) Work Contract Tax/GSTN Registration Number.
- g) Labor License under Contract Labor Act (R & A) Act 1970(All Engineer-in-charge responsible for execution of the job should obtain a copy of Labor License as per guidelines of HR department before start of the work by the contractor.)

The Contractor must follow:

- a) Third party Insurance Policy before start of work.
- b) To follow Minimum Wages Act prevailing in the state.
- c) Salary/ Wages to be distributed in presence of Company's representative not later than 7th of each month.
- d) To maintain Wage- cum - Attendance Register.
- e) To maintain First Aid Box at Site.
- f) Latest P.F. and E.S.I. challans pertaining to the period in which work was undertaken along with a certificate mentioning that P.F. and E.S.I. applicable to all the employees has been deducted and deposited with the Authorities within the time limits specified under the respective Acts.
- g) Workman Compensation Policy. (If applicable)
- h) Labor license before start of work. (If applicable)

### INSURANCE POLICY

Before commencing the execution of the work the CONTRACTOR shall take accidental insurance policy for the staff engaged by him for this work to insure against any loss of life which may occur during the contract for the work of the COMPANY. The policy shall have coverage of Rs. 10 Lacs (Table C- Death + Permanent Total Disability + Partial permanent Disability due to external accidents). The premium amount for such policy shall be in contractor scope. The policy document shall be submitted before commencement of the work by the contractor.

## **ANNEXURE-II**

### **SCOPE DEMARACATION AND ROUTE MAP**

## Scope Demarcations

S.No.	Head	BRPL Scope	Contractor's Scope	Remarks
1	Road Cutting Permission	X	√	Statutory fees will be borne by BRPL
2	Supply, Laying, testing and commissioning of 11kv/33kv/66kV cable , Cable Jointing, Cable termination including laying , testing and commissioning of OFC joint and OFC termination.	X	√	NA
3	Permissions from relevant External and Internal Agencies regarding Cable Laying and Commissioning (Traffic Police, GAIL, IGL, IOCL, PWD, CPWD, Pollution Control Board, DMRC etc.)	X	√	Statutory fees will be borne by BRPL
4	Supply, Erection, Testing and commissioning of Equipments related to schemes like CT, CVT, CB, Isolator, LA etc. if any.	X	√	As per specifications and Standards
5	Supply and Erection of structure for mounting equipments in the bay like structure for CT, CVT, CB, Isolator, LA etc.	X	√	
6	GPR/Scanning of the whole route shall be done and the same shall be submitted to BRPL. The report shall be submitted within 15 days after the issue of LOI/PO.	X	√	This work shall be done by vendor before execution of job.
7	Drawing Submissions	X	√	NA
8	Engineering Approvals	√	X	NA
9	Testing Equipments	X	√	NA
10	Lighting Arrangement	X	√	NA
11	Construction Power and Construction Water	X	√	NA
12	Safety , Security and insurance of Manpower (Labour, Engineers, Supervisors etc)	X	√	Labour should be provided with every safety gear like safety jacket, helmet etc.
13	Various Tools and Tackles related to Job	X	√	NA
14	Transportation of Material and any other tender related work	X	√	NA
15	Cleanliness around project site	X	√	NA

S.No.	Head	BRPL Scope	Contractor's Scope	Remarks
16	Security and Safety of material until handing over the project to BRPL	X	√	NA
17	Providing of Various Machines e.g Crane, Hydra, JCB, Hammer , Cutting Machine etc to complete the project	X	√	NA
18	Providing of Trenchless Machine	X	√	NA
19	Loading and Unloading of material at site including scrap returning to BRPL site	X	√	NA
20	Electrical Inspector Clearance	X	√	Statutory fees will be borne by BRPL
21	Providing of Continuous Steel Barricading with Mobile no of project supervisor, sufficient traffic marshal, becon light, Fluorescent tape, PPE etc. (Mobile no shall be clearly visible on the barricading)	X	√	as per drawing enclosed with specification.
22	Permit to work requesting Agency in BRPL premises	X	√	Permit Should be applied to Engineer Incharge prior to work through proper procedure
23	Permit to work issuing agency inside BRPL Premises	√	X	NA
24	Temporary office and Material Store near work premises	X	√	NA
25	Storage of all kind of Material required for project	X	√	BRPL premises will not provide for any kind of material storage and issuance
26	Dismantling of material at project site, , Dismantled material loading, Unloading and transportation and deposit to BRPL store	X	√	Store location will be within BRPL premises
27	Preparation, updation and submission of PERT chart fortnightly to track activities	X	√	NA
28	Submission of final drawing showing layout of cable in Google map alongwith of cable joint location with GPS Coordinates	X	√	Approval will be done by BRPL Representative
29	Removal and renaming of existing signboard of other utilities (if any) including painting as per their actual route	X	√	Painting colour and material should be in line with the existing ones for aesthetic look

S.No.	Head	BRPL Scope	Contractor's Scope	Remarks
30	Surface levelling, removal and disposal of excess earth (malwa) after back filling of trench. During execution excavated earth shall be covered with green mat to prevent dust pollution. Also regular Water Sprinkling is to be required at site.	X	√	NA
31	Supply, installation, testing and commissioning of Active and Passive ball markers	X	√	NA
32	Supply & installing of RCC cable route marker, RCC cable joint marker and RCC Coffin for joint. , RCC slab, warning tape etc.	X	√	Shall be designed as per tender document
33	Cable Route Tracer and Marker-supply, testing and commissioning (as applicable)	X	√	NA
34	Sheath Integrity test before Charging of Cable	X	√	NA
35	All cable drum shall be returnable basis so immediate after laying of cable, empty cable drum shall be removed away from site at their risk and cost by respective bidder from time to time in line with project progress.	X	√	
36	Compliance of instructions/ orders issued by National Green Tribunal/ Central Pollution Control Board/ any other agency related to pollution.	X	√	Any kind of penalty shall be borne by the vendor
37	De-watering of pits	X	√	Scope shall be covered as per execution team requirement.

**Special requirement**

1. All the joints shall be covered with RCC coffin. Each coffin or nos of coffin shall fully cover the joint. Drawing provided only for constructional purpose not showing complete length of coffin. Bidder has to consider coffin length or numbers such that the complete joint shall be covered.
2. Delivery of cable at site and all other associate equipments/accessories have to be aligned as per site requirement and progress.
3. All kind of structural steel shall be GI unless otherwise specified.
4. Make of all kind of materials shall be as per BRPL approved make list, no deviation shall be allowed from make list.



5. Cable drum no shall be included by embossing or by laser printing at a interval of 1 meter on the outer sheath of the cable.
  6. HDPE pipe make shall be from Flow well, Tirupati, Narendra Poly plast and EON plast
  7. Type test required after award of PO for cable
- a) Type test-1(To be borne by the bidder): Sample for Type test shall be taken from one randomly selected drum from any lot of each type/rating of PO. Sample shall be sent to CPRI/ERDA by respective OEM to conduct type test as per relevant IS/IEC. Cost of this type test shall be borne by respective bidder.
- ii) Type test -2: Type test on one cable drum of each type/rating from any lot shall be conducted at CPRI/ERDA on sample basis as per relevant IS/IEC. Sample shall be sealed by BRPL during inspection of cable. This type test is applicable subject to BRPL requirement and cost shall be borne by BRPL.

**SCHEDULE -1**  
**TECHNICAL DEVIATION FROM THE SPECIFICATION**  
(This shall be part of Technical bid)

Technical deviation from specification if any, shall be listed out in below format

Sl no	Specification cl no	Deviation	Remark

**Route MAP-1**

**A. Shifting/Relocation of 33kV feeders (IP to Kilokari Bay no. 1 & 3) and 33kV O/H D/C line Bay 25 & 37 at Sarai Kale khan\_ NCRTC**

**Circuit-1**

Shifting/Relocation of 33kV feeders (IP to Kilokari Bay no. 1 & 3) and 33kV O/H D/C line bay 25 & 37 at Sarai Kale khan on account of NCRTC.

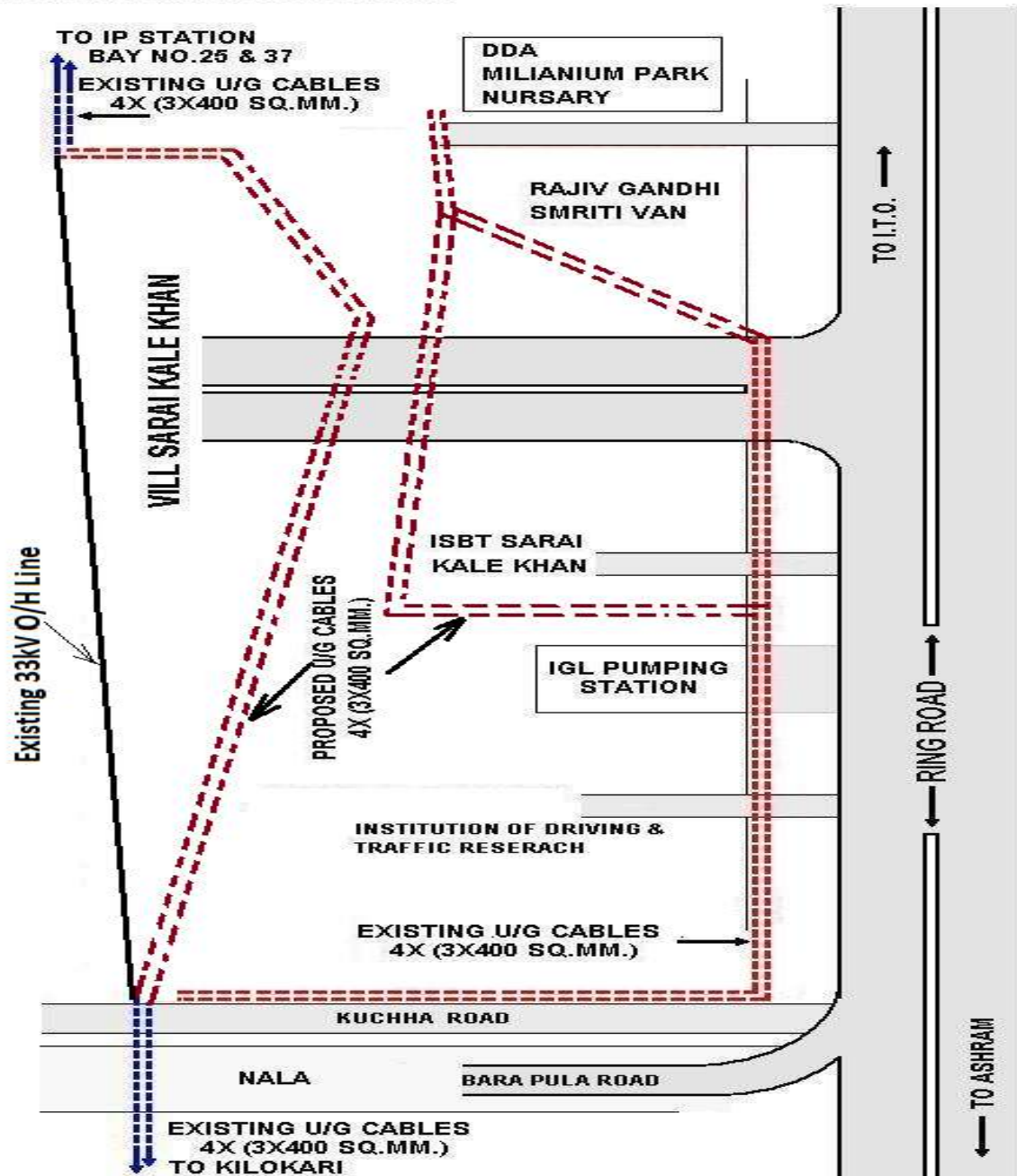

**Route MAP-2**

**A. Shifting/Relocation of 11kV feeders at Sarai Kale khan\_ NCRTC  
Circuit-2**

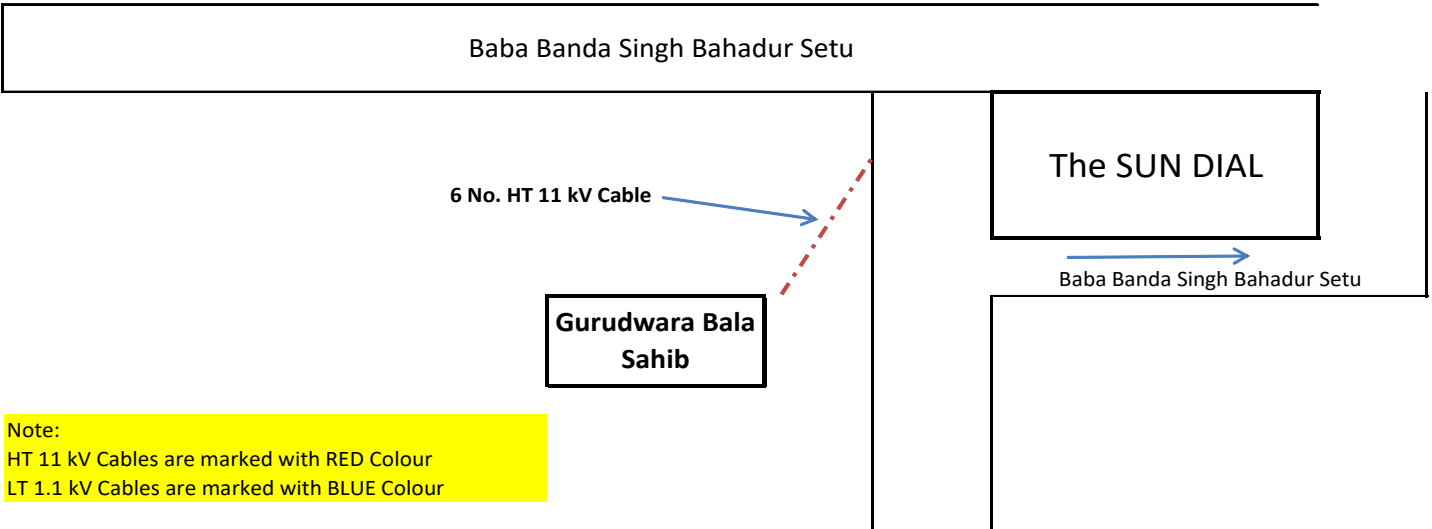
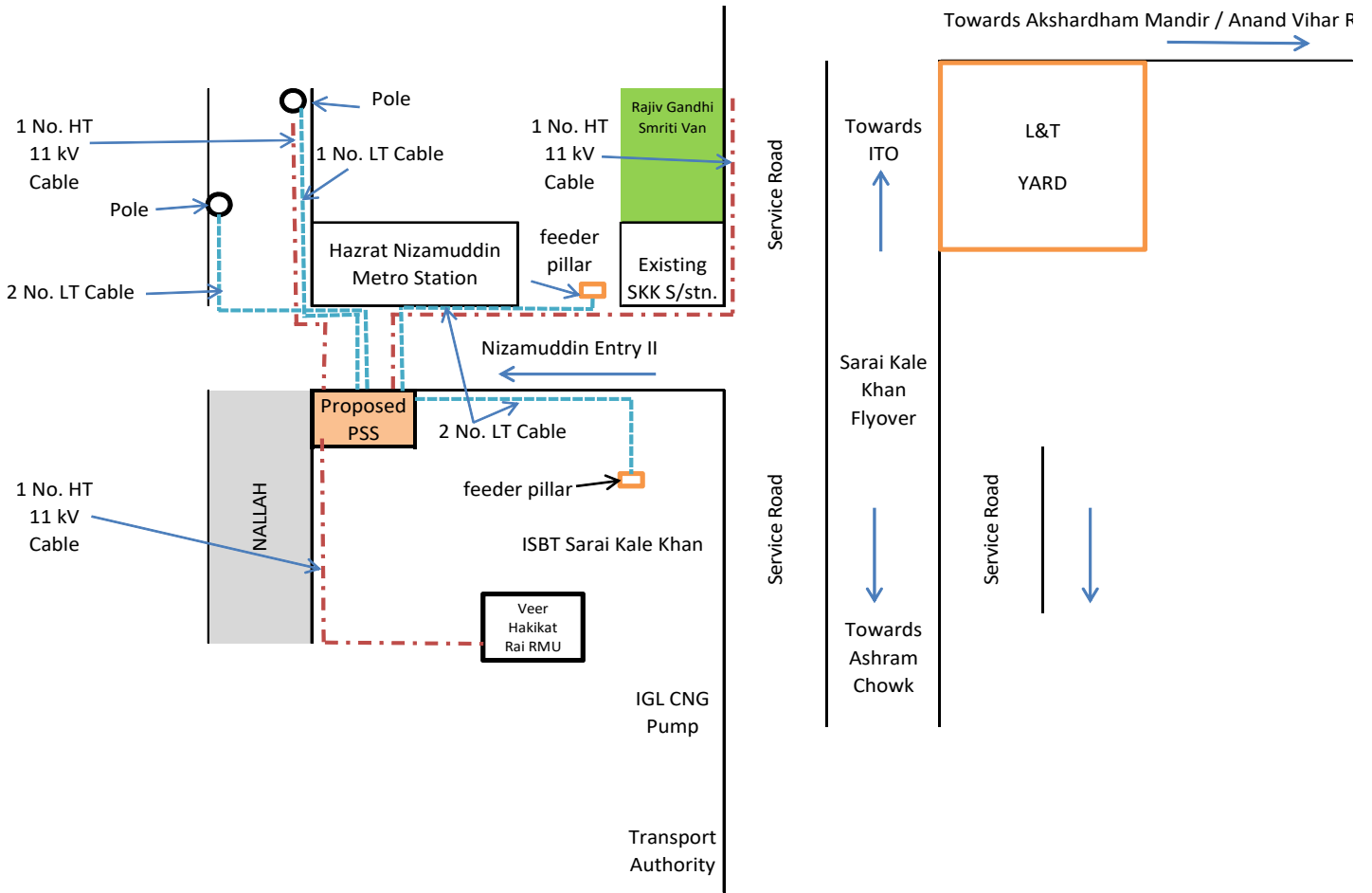

**Note:**  
 HT 11 kV Cables are marked with RED Colour  
 LT 1.1 kV Cables are marked with BLUE Colour

## **ANNEXURE-III**

# **TECHNICAL SPECIFICATIONS**



## Technical Specification

For

## 33kV,3CX400 sqmm Cable

Specification No: SP-EWHP-01- R5

Prepared by		Reviewed by		Approved by		Rev./Pages	Date
Name	Sign	Name	Sign	Name	Sign	5/43	22.11.2019
Gautam Deka		Amit Tomar		K. Sheshadri			
Pronab Bairagi							

	<b>Index</b>	<b>[R4]</b>	<b>Page</b>
<b>Revision Record</b>	.....		<b>3</b>
<b>General Specification</b>	.....		<b>5</b>
<b>Annexures:</b>			
<b>Annexure A:</b>	.....		<b>18</b>
<b>Scope, Documentation and Delivery Schedule</b>			
<b>Annexure B:</b>	.....		<b>20</b>
<b>General Technical Particulars (GTP)</b>			
<b>Annexure C:</b>	.....	<b>[R4]</b>	<b>27</b>
<b>List of R-Infra approved Sub-Vendors</b>			
<b>Annexure D :</b>	.....	<b>[R4]</b>	<b>29</b>
<b>Service Conditions</b>			
<b>Annexure E:</b>	.....		<b>30</b>
<b>(Attachments)</b>			
<b>a) General Arrangement Drawing for Pulling-eye Assembly</b>			
<b>b) General Arrangement Drawing for End-sealing Cap</b>			
<b>Annexure F:</b>	.....	<b>[R4]</b>	<b>33</b>
<b>(Attachment)</b>			
<b>R-Infra format (typical) for Quality Assurance Plan (QAP) for H. T. Cables</b>			
<b>Annexure G:</b>	.....	<b>[R4]</b>	<b>42</b>
<b>Testing and manufacturing process requirements w. r. t. TR- XLPE insulation</b>			

### Revision Record

Note:

Revisions made in R4 are marked by symbol [R4] at the respective text or drawing throughout the Specification.

[R4]

Rev. No.	Revision Date	Item/ clause no:	Page No.	Nature of Change	Approved by
R4	09.03.12	Cl. 1.0.0 ,	5	IS 0462 (Part1)/1983 - added	AM
R4	09.03.12	Cl. 1.0.0 ,	5	IEC 332 - added	AM
R4	09.03.12	Cl. 2.0.0 , GTP 5.0	5	Cable Code - added	AM
R4	09.03.12	Cl. 2.0.0 ,  GTP 5.0 (Annexure-B)	5	For 33 kV 3-core Cables only armour strips (not armour wires).	AM
R4	09.03.12	Cl. 2.0.0	5	1c x 630 sq. mm. Cables - added.	AM
R4	09.03.12	Cl. 2.1.1	7	Copper conductor - deleted.	AM
R4	09.03.12	Cl. 2.1.1	7	Conductor Al grade H4 - deleted	AM
R4	09.03.12	Cl. 2.1.1, GTP 8.0	7	"Longitudinal Water Blocking Arrangement" within conductor - added	AM
R4	09.03.12	Cl. 2.1.3, GTP-10.0	7	Eccentricity check with regard to Insulation - added	AM
R4	09.03.12	Cl. 2.1.4, GTP-11A.0	8	Ovality check on core (over outer semi-con) - added	AM
R4	09.03.12	Cl. 2.1.4A , GTP 28.0	8	For 11 kV Cables also : "Dry-cure process only" (no moisture cure)	AM
R4	09.03.12	Cl. 2.1.6 , GTP 11C	9	Colour strips to carry manufacturer's name also.	AM
R4	09.03.12	Cl. 2.1.6	9	Copper tape arrangement - added	AM
R4	09.03.12	Cl. 2.1.7	9	Properties of PP filler - added	AM
R4	09.03.12	Cl. 2.1.10	9	Zero negative tolerance for diameter of armour wire - added	AM
R4	09.03.12	Cl. 2.1.12	10	Anti-rodent properties for outer sheath - added	AM
R4	09.03.12	Cl. 2.1.12	10	Ovality check over completed cable - added.	AM
R4	09.03.12	Cl. 2.1.12, GTP 15.0	10	FRLS properties for outer sheath, when required - added	AM
R4	09.03.12	Cl. 2.1.12	10-11	Details of Embossing - revised	AM
R4	09.03.12	Cl. 4.0.0	12	R- Infra QAP detail added	AM
R4	09.03.12	Cl. 4.0.0	12	Strippability Test added in Routine Test and Acceptance Test.	AM
R4	09.03.12	Cl. 4.0.0	12	Minimum lot size of Cables for	AM



				raising Inspection Call - added	
R4	09.03.12	Cl. 4.0.0	13	Water Penetration Test (WPT) - added	AM
R4	09.03.12	Cl. 4.0.0	13	Make & Grade of critical items used during manufacture to be stated in TC - added	AM
R4	09.03.12	Cl. 5.0.0, GTP 18A.0	14	Cross-sectional drawing - added (required details mentioned)	AM
R4	09.03.12	Cl. 7.0.0 , GTP 18.0	15-16	a) Required Packing details mentioned. b) Drum Identification markings - revised c) M. S. Spindle required for drums - added f) Cable drum handling added	AM
R4	09.03.12	Annexure - A	18	a) Document Submission - revised b) Delivery Schedule - added	AM
R4	09.03.12	Annexure-B (GTP)	20	One consolidated GTP format is prepared, instead of earlier separate GTPs for different types of cables.	AM
R4	09.03.12	Annexure-B (GTP)	20	GTP generally revised as per revised clauses.	AM
R4	09.03.12	Annexure-B GTP 8H.0	21	Longitudinal Water blocking arrangement added	AM
R4	09.03.12	Annexure-B GTP 9.0	21	Conductor Screen thickness revised to 0.5 min.	AM
R4	09.03.12	Annexure-B (GTP) – 11B.0	22	Approval for Pre-slitted w. s. tapes from sub-vendors necessary. - added	AM
R4	09.03.12	Annexure-B GTP – 11D.0	22	Thickness of Copper Tape increased from 0.06 to 0.1 mm	AM
R4	09.03.12	Annexure-B (GTP) - 13.0	23	Inner Sheath – min thickness for 11 kV, 1cx1000 sq.mm. increased from 0.6 to 0.7 mm	AM
R4	09.03.12	Annexure-B (GTP) – 17A.0	24	Overall order tolerance - added	AM
R4	09.03.12	Annexure-C , Cl. 2.1.3 , GTP-31.0	27	R-Infra Approved Sub-Vendors List - added	AM
R4	09.03.12	Annexure-D	29	Service Conditions – added.	AM
R4	09.03.12	Annexure-E	31-32	For Pulling-eye Assembly and Sealing-end Cap, new drawings added.	AM
R4	09.03.12	i) Annexure-F (QAP) ii) Cl. 4.0.0 iii) GTP-30.0	34 to 41	QAP format - added.	AM
R4	09.03.12	Cl. 2.1.3	8	Introduction of “water-tree retardant” property for XLPE insulation	AM
		GTP 10.0-G	21		
R4	09.03.12	Annexure-G	42	Introduction of “water-tree retardant” property for XLPE insulation	AM

### Revision Details

Sl. no	Clause no.	Item descriptions	As per old Technical Specification(SP-EWHP-01- R4)	As per Revised Technical Specification(SP-EWHP-01- R5)	Date of approval	Approved by
1	2.1.12	Embossing and printing	Drum no. was not included	Drum no shall be embossed or printing on outer sheath.	22/11/2019	KS
2	Newly Added in Annexure-G	Type Test	Type test report with validity 5 years only	<u>Type Test Required After Award of PO:</u> i) Type test-1: Type test on one cable drum of each type/rating from any lot, shall be conducted at CPRI/ERDA on sample basis as per relevant IS/IEC. Sample shall be sealed by BRPL during inspection of cable. Cost for this type test shall be borne by the respective Bidder. ii) Type test -2: Type test on one cable drum of each type/rating from any lot shall be conducted at CPRI/ERDA on sample basis as per relevant IS/IEC. Sample shall be sealed by BRPL during inspection of cable. This type test is applicable subject to BRPL requirement and cost shall be borne by BRPL.	22/11/2019	KS
3	7.0.0-e	Type of Drum	Steel/Wooden	Only Steel non returnable	22/11/2019	KS
4	2.1.4A-2	Type of Cooling of core	Water/Moisture Cooling	Only Dry Cooling	22/11/2019	KS
5	---	Technical Specification details	Technical Specification for HT cable (11 and 33kV: 1 Core/3 Core)	Technical Specification for 33kV, 3CX400 sqmm (For Technical Specification of 11kV, 3CX300 sqmm, 3CX150 sqmm and for 1CX1000 sqmm Cable - refere technical specification no: GN101-03-SP-172-00)	22/11/2019	KS

Gautam Deka/  
Pronab Bairagi  
Prepared by

Amit Tomar  
Reviewed by

K. Sheshadri  
Approved by

## General Specification

### 1.0.0 Codes & Standards

The cables shall be designed, manufactured and tested in accordance with the following National Standards and IEC Standards.

#### National Standards

IS 7098 Part-2	Cross linked polyethylene (XLPE) insulated PVC sheathed cables for working voltages from 3.3 kV up to and including 33 kV.
IS 5831 : 1984	PVC insulation & sheath of electric cables.
IS 10810 : 1984	Methods of test for cables.
IS 8130 : 1984	Conductors for insulated electric cables and flexible cords.
IS 3975 : 1999	Mild steel wires, formed wires and tapes for armouring of cables.
IS 0462 (Part 1) / 1983	Fictitious Calculation Method for determination of dimensions of protective covering of cables

#### International Standards

IEC 60183	Guide to the selection of high voltage cables
IEC 60228	Conductors of insulated cables. Guide to the dimensional limits of circular conductors.
IEC 60332 - 3	Tests on electric cables under fire conditions. Part 3: Tests on bunched wires or cables.
IEC 60502 - 2	Power cables for rated voltages from 6 kV ( $U_m = 7.2$ kV) up to 30 kV ( $U_m = 36$ kV)
IEC 60811 Pts 1 through 5	Common test methods for insulating and sheathing materials of electric cables.
IEC 885 Pts 1 through 3	Electric test methods for electric cables.
IEC 28	International Standard of Resistance for Copper
IEC 332	Test on Electric Cables under fire conditions

### 2.0.0 Cable Construction Features

This Specification generally covers following types / sizes of TR-XLPE H. T. Cables used in BRPL network in Delhi Discom area, mostly under-ground (buried, with

chances of flooding by water) or for laying on racks, in ducts, trenches, conduits, and so on.

Note: (Ref.: Table stating Cable sizes given below.)

Cable Code: **[R4]**

As per IS, cable designations comprise of following codes / options, as applicable for this Specification:

(N.A. - Not applicable for Specification)

- (with Copper conductor) (N.A.) **[R4]**

A Aluminium conductor

-----  
 2X XLPE insulation  
 -----

W Steel round Wire armour (N.A.)

W W Double steel round Wire armour (N.A.)

Wa Non-magnetic round Wire armour

F Steel formed wire (strip) armour

FF Double steel formed wire (strip) armour (N.A.)

Fa Non-magnetic formed wire (strip) armour (N.A.)

- ("un-armoured" or without armour) (N.A.)  
 -----

Y PVC outer sheath

Sr. No.	Description	Conductor Material	Cable Code <b>[R4]</b>
1.	11 kV, 3c x 150 sq. mm.	Al	A 2X F Y
2.	11 kV, 3c x 300 sq. mm.	Al	A 2X F Y
3.	33 kV, 3c x 400 sq. mm.	Al	A 2X F Y
4.	33 kV, 1c x 630 sq. mm. <b>[R4]</b>	Al	A 2X Wa Y
5.	11 kV, 1c x 1000 sq. mm.	Al	A 2X Wa Y
6.	33 kV, 1c x 1000 sq. mm	Al	A 2X Wa Y

Description of each item mentioned in the Specification (the text, BOQ, GTP or any site specific requirement) shall be followed, along with IS: 7098 – Part 2.

2.1.1	<b>Conductor</b>	<ul style="list-style-type: none"> <li>a) Electrolytic Grade Stranded Aluminium Conductor <b>[R4]</b></li> <li>b) Grade: H2 as per IS: 8130 / 1984 (For Al) <b>[R4]</b></li> <li>c) Stranded, compacted and circular in shape</li> <li>d) Class 2</li> <li>e) “Longitudinal Water-Blocking Arrangement” (or water-tight construction or water barrier protection) shall be provided within the Conductor. <b>[R4]</b> <ul style="list-style-type: none"> <li>i) As per manufacturer’s procedures, 100 % water-tight conductor shall be achieved.</li> <li>iii) Make &amp; Type of materials to be used (i.e. Water-swellable tapes / yarn / powder, etc.) shall also be stated in the List of Sub-Vendors for pre-order approval.</li> </ul> </li> <li>f) All detailed constructional features shall be shown in the cross-sectional drawing.</li> </ul>
2.1.2	<b>Conductor Screen</b>	<p>Extruded semi-conducting material. (Also refer Cl. 2.1.3.) (Tapes are not acceptable)</p>
2.1.3	<b>Insulation</b>	<ul style="list-style-type: none"> <li>a) Extruded XLPE (Cross-Linked Poly-Ethylene) Insulation, with water-tree retardant (WTR) property<b>[R4]</b></li> <li>b) The required compound used shall be from R-Infra-approved sub-vendors and not from any other (refer Annexure – C). <b>[R4]</b></li> <li>c) Uniform thickness of insulation shall be within the permissible values as per IEC Standards;</li> </ul>

eccentricity check shall be carried out to ensure

		<p>this. [R4]</p> <p>d) Insulation Color : natural</p>
2.1.4	<b>Insulation Screen</b>	<p>a) Freely-strippable semi-conducting screen, which should not require application of heat for its removal. (Refer Cl. 2.1.3.)</p> <p>b) Text “Do not Heat - Freely Strippable” to be printed on insulation screen (at every 600 mm interval).</p> <p>c) Round shape over the outer semi-con shall be within the permissible limits as per IEC standards; Ovality check shall be carried out to ensure this. [R4]</p> <p>d) Compound used shall be suitable for the operating temperature of the Cable and shall be compatible with the insulation used. [R4]</p>
2.1.4A	<b>TR-XLPE Process</b>	
2.1.4A-1	11 KV	Dry Cure process only. [R4]
2.1.4A-2	33 KV	Dry Cure and Dry Cooling process only.
2.1.4A-3	Extrusion	It is desirable that Conductor Screen, Insulation and
	[R4]	Insulation Screen shall be extruded simultaneously, in a Single One-Time Process (i.e. as a triple-head extrusion) to ensure homogeneity of layers over the conductor, and absence of voids. However, Tandem Extrusion (1+2) is also acceptable
2.1.4A-4	Make of Compounds for	Any deviation from Approved Makes mentioned in
	Insulation and Semi-conducting	Annexure-C shall not be acceptable, unless the deviation has been specifically approved by R-Infra, prior to sourcing the compounds and taking up manufacturing of cable.
2.1.5	<b>Water-Swellable Tape</b>	a) Semi-Conducting Water-Sellable Tape shall be provided, under the copper tape, on each core.

		<ul style="list-style-type: none"> <li>b) Nominal thickness : 0.3 mm</li> <li>c) Weight: 118 gm / sq. m apprx.</li> <li>d) Swell height: <math>\geq 12</math> mm in 1 min.</li> <li>e) Compatible to strippable / non-strippable semi-con, over which it is applied.</li> </ul>
2.1.6	<b>Core Identification</b>	<ul style="list-style-type: none"> <li>a) For 3-core cables, cores shall be identified by coloured strips (Red, Yellow, Blue), applied helically / longitudinally below the copper tape. The coloured strips shall carry the name of manufacturer permanently printed at close intervals; this is to provide additional identification of manufacturer of the cable. <b>[R4]</b></li> </ul>
2.1.6A	<b>Copper Tape</b>	Copper Tape shall be applied helically over the layer formed after application of insulation screen, water-swellaable tape and identification strip. <b>[R4]</b>
2.1.7	<b>Filler</b>	<ul style="list-style-type: none"> <li>a) All interstices, including center interstices shall be filled by PP filler &amp; OFC(ref:OFC Note for detail)</li> <li>b) PP Filler shall be non-hygroscopic, not having any effect on other compounds used, stable at cable temperatures, etc. <b>[R4]</b></li> <li>c) PVC filler is not acceptable.</li> <li>d) Filler is not applicable for single-core cables.</li> </ul>
2.1.8	<b>Binder Tape</b>	As per manufacturer's standard
2.1.9	<b>Inner Sheath</b>	Extruded Inner Sheath of Black PVC type ST-2 (IS 5831)
2.1.10	<b>Armour</b>	<ul style="list-style-type: none"> <li>a) For 3-core Cables : Galvanised Steel flat strip armour</li> <li>b) For 1-core Cables : Non-magnetic round wire armour</li> </ul>

		<p>(hard-drawn aluminium wire)</p> <p>c) Minimum area of coverage of armouring shall be 90 % (min.). At any time, the gap between any two adjacent armour strips / wires shall not be more than the width of strip / diameter of wire.</p> <p>d) Zero negative tolerance is for :</p> <ul style="list-style-type: none"> <li>• Thickness of armour strip</li> <li>• Diameter of armour wire <b>[R4]</b></li> </ul>
2.1.11	<b>Binder Tape</b>	Rubberised cotton tape
2.1.12	<b>Outer Sheath</b>	<p>a) Extruded outer sheath of PVC (ST-2 as per IS 5831) with termite-repellant and anti-rodent properties. <b>[R4]</b></p> <p>(Outer Sheath shall be FRLS-type, if chosen by purchaser.) <b>[R4]</b></p>
		<p>b) Shape of the cable over the outer sheath shall be circular, when manufactured / completed. Regular Ovality check shall be carried out at factory, to detect any abnormality. Manufacturing quality shall be such that cable will retain its circular shape, even after it is laid at site. <b>[R4]</b></p>
		<p>c) The Outer Sheath shall be embossed with following minimum text : <b>[R4]</b></p> <ol style="list-style-type: none"> <li>1. The voltage designation</li> <li>2. Type of construction / cable code (e.g. A2XFY)</li> <li>3. Manufacturer's Name and Trade-mark</li> <li>4. Number of cores and nominal cross-sectional area of conductor</li> <li>5. Progressive (sequential) length of cable at every metre, starting from zero for every drum.</li> </ol> <p>Colour filled in for the progressive marking,</p>



		<p>shall be with proper contrast in colouring.</p> <p>6. Name of buyer / purchaser, (Reliance Infrastructure Ltd.)</p> <p>7. Month &amp; Year of manufacturing</p> <p>8. IS reference, i.e. IS : 7098</p> <p>9. Batch No. / Lot No. &amp; Drum no. (For traceability purpose, in case of any, in case of any manufacturing defect or otherwise arising in the cable in future.)</p> <p>10. Purchase Order Number &amp; date</p> <p>11. Word ' FRLSH ', in case the cable is of FRLSH type. [R4]</p>
2.1.13	<p><b>Pulling-eye Assembly</b> and <b>Sealing-end Cap</b> (for Cables)</p>	<p>a) A cable pulling-eye assembly Drg. No. MISC/E/4-1131/1698 (see Annexure-E) shall be provided at the loose end (outer end) of the cable on each drum. Sealing material shall be filled in inside the spaces / gaps between the pulling-eye assembly and cable outer sheath. Further, a heat-shrinkable sleeve shall be provided over the pulling-eye assembly and outer sheath of cable.</p> <p>b) Other end (inner end) of the cable shall be sealed as per MISC/E/4-1131/1699 (see Annexure-E.) One PVC cap with Polyurethane compound shall be provided as primary sealing and heat-shrink end-cap shall form a secondary sealing over the PVC cap.</p>
3.0.0	(This number not used.)	
4.0.0	<b>Testing &amp; Inspection</b>	Tests shall be carried out in accordance with IS 7098 (Part-2).
	a) Type Tests	1. Cables must be of type tested quality. Type Test Reports shall be submitted for the type, size and

		<p>rating of cable offered in the bid.</p> <ol style="list-style-type: none"> <li>2. If the manufacturer's laboratory is accredited by govt. /authorized body, then it shall be acceptable for type testing.</li> <li>3. Type test on one cable drum of each type/rating, from the first lot, shall be conducted at Govt.- approved / Internationally accredited labs.</li> </ol>
	<p>b) R-Infra QAP (Typical) <b>[R4]</b></p>	<p>In general, all tests mentioned in the R-Infra QAP (Characteristics – Typical) mentioned in Annexure-F shall be included in the Routine Tests, Type Tests and Acceptance Tests stated above.</p>
	<p>c) Routine Tests</p>	<ol style="list-style-type: none"> <li>1. Measurement of Electrical Resistance</li> <li>2. HV Test with power frequency AC voltage</li> <li>3. PD test</li> <li>4. "Strippability Test" at both the ends of cable for each drum, to check the freely-strippable property of the Insulation Screen (outer semi-con). <b>[R4]</b></li> </ol> <p>Test results from the above tests must appear in the documents forwarded by the vendor for Inspection call / waiver.</p>
	<p>d) Inspection</p>	<ol style="list-style-type: none"> <li>1. The Buyer reserves the right to witness all tests specified on completed cables.</li> <li>2. The Buyer reserves the right to inspect cables at Sellers works at any time prior to dispatch, to verify compliance with the specifications.</li> <li>3. In-process (stage inspection) and final inspection call intimation shall be given sufficiently in advance to the purchaser.</li> <li>4. Minimum lot size of Cables to be offered for inspection shall be mutually agreed between Purchaser and Vendor, before placing the order. Vendor shall raise inspection call only after a minimum lot size is ready and with due factory routine tests already carried out. <b>[R4]</b></li> </ol>
	<p>e) Acceptance Tests</p>	<p>Acceptance Tests shall be conducted as per Cl. 18.2</p>

		<p>of IS 7098 (Part-2) and the approved Quality Assurance Plan (QAP) for each lot of cables.</p> <p>Following tests shall also be carried out during the Acceptance Tests :</p> <p>a) "Wafer Boil Test" for checking integrity of semi-conducting layers.</p> <p>b) "Void-and-contamination Test" for the Insulation</p> <p>c) "Strippability Test" at both the ends of cable for each drum, to check freely-strippable property of the Insulation Screen (outer semi-con). <b>[R4]</b></p> <p>d) "Water Penetration Test (WPT)", as per applicable IEC standards, to check adequacy of water-blocking arrangement provided inside the conductor. <b>[R4]</b></p> <p>Number of times WPT is to be carried out, during Acceptance Test, shall be mutually agreed and generally determined as follows :</p> <p>a) For the order Qty. &lt; 50 kms : One no. WPT</p> <p>b) For the order Qty. &lt; 50 kms : Two times WPT <b>[R4]</b></p>
	f) Test Certificates (TC)	<p>Three sets of complete Test Certificates (Routine tests and Acceptance tests) shall be submitted along with the delivery of cables.</p> <p>Soft copy of the TCs shall be separately e-mailed to the Purchaser. <b>[R4]</b></p> <p><b>Note :</b> <b>[R4]</b></p> <p>Make/grades of critical materials (such as, for conductor screen, insulation, insulation screen, etc.), actually used during manufacturing of cables for order-on-hand, shall be clearly stated in the TCs forwarded by the Manufacturer, enabling references in future.</p>
5.0.0	<b>Drawing, Data and Manuals</b>	a) Refer Annexure-A regarding Document Submission.

		b) Cross-Sectional Drawing shall show every feature of construction, including the thickness / diameter over every layer. This drawing shall also state the text to be embossed over the outer sheath - i.e. type/size, etc. of the cable, drum no./lot no., sequential marking over every meter, printing text on outer semi-con (“Do Not Heat-Freely Strippable”), font sizes to be used, additional text, if any, etc. Also, drum details, markings to be made on both sides of the drum, and so on. <b>[R4]</b>
5.0.1	Documents to be submitted along with bid	The vendor shall submit : a) Cross-sectional drawing <b>[R4]</b> b) GTP (all data to appear) c) Type Test certificates d) Dimensional drawing for pulling eye e) Fault Level Calculation for armour and copper tape screen f) Complete Cable Catalogue and Manual g) Armour Coverage Calculation
5.0.2	Documents after award of contract	Within 15 days, the seller has to submit four sets of above-mentioned drawings, along with one soft copy for buyer’s approval.
5.0.3	Final As-Built Drawings	One soft copy of all documents, including type & routine test certificates.
6.0.0	<b>Drum length &amp; tolerance</b>	Cable length per drum
6.0.1	a) 11 KV, Three core b) 33 KV, Three core c) 11 KV, Single core d) 33 KV, Single core	a) 300 mtr +/- 5 % b) 200 mtr +/- 5 % c) 500 mtr +/- 5 % d) 500 mtr +/- 5 %
6.0.2	Overall tolerance	+/- 2 % for the total cable length for the entire order.

6.0.3	Short length of cables	<p>Manufacturer shall take prior approval from Purchaser for any supply of short length cables.</p> <p>For 33 KV, 3-core/1-core cables, minimum acceptable short length cable can be 150 meter and 250 meter respectively. Similarly, for 11 KV cables, minimum acceptable short length cables can be 250 meter.</p> <p>In any case, manufacturer shall not put two cable pieces of different short lengths in same cable drum.</p>
7.0.0	<b>Packing, Shipping, Handling &amp; Storage</b>	
	a) Packing	<p><b>[R4]</b></p> <ol style="list-style-type: none"> <li>1. Both the ends of the cables shall be properly sealed to prevent any deterioration of the cable, due to ingress of water, etc.</li> <li>2. Cable inner end (starting end) shall project, outside the completely wound cable, by sufficient length enabling verify cable details, including the initial length marking.</li> <li>3. Similarly, outer end of the cable shall be saddled / secured to the drum properly to prevent any external damage to the end at any time.</li> <li>4. Before putting on wooden planks, protective covers (thick plastic sheets, etc.) shall be secured over the wound cable, to avoid any abrasion by wooden planks, over the outer sheath of the cable.</li> <li>5. After providing the protective covers, the cable drums shall be finally closed by wooden planks (with saddles), without leaving any gaps between the planks; i.e. 100 % covering shall be</li> </ol>

		ensured.
	b) Drum Identification Markings:	<p>Direct marking (i.e. text painting through stencils, etc.) shall be done on the drums, instead of attaching labels, which may be misplaced/lost over a period of time. <b>[R4]</b></p> <ol style="list-style-type: none"> <li>1. Drum identification number</li> <li>2. Cable voltage grade</li> <li>3. Cable code (e.g. A2XFY, etc.)</li> <li>4. Number of cores and cross sectional area</li> <li>5. Cable quantity, i.e. cable length (metre)</li> <li>6. Purchase order number &amp; date</li> <li>7. SAP item code</li> <li>8. Total weight of cable and drum (kg)</li> <li>9. Manufacturer's Name</li> <li>10. Buyer's name</li> <li>11. Month &amp; Year of Manufacturing</li> <li>12. Direction of rotation of drum</li> <li>13. Cable length final end-markings (i.e., reading at the inner end and reading at the outer end, just before packing, shall be marked on the drum.)</li> </ol>
	c) Shipping information	The seller shall give complete shipping information concerning the weight, size of each package
	d) Transit damage	The seller shall be responsible for any transit damage due to improper packing.
	e) Type of Drum	Steel drums, as per relevant IS / IEC. (Steel drums shall be with M.S. spindle plate with nut-bolts)
	f) Cable Drum handling	The drums shall be with M.S. spindle plate (with nut-bolts) of adequate size to suit the spindle rods, normally required for handling the drums, according to expected weight of the cable drums. <b>[R4]</b>
8.0.0	<b>Quality Assurance Plan (QAP)</b>	
8.0.1	Vendor's QAP	Manufacturer shall submit QAP in line with R-Infra

		QAP format (Annexure-F) for purchaser's approval. <b>[R4]</b>
8.0.2	Inspection Points	To be mutually identified and agreed upon in QAP.
9.0.0	<b>Progress Reporting</b>	
9.0.1	Outline Document	To be submitted for purchaser's approval for outline of programmes for production, stage-inspection, testing, final inspection, packing, dispatch and documentation.
9.0.2	Detailed Progress Report	To be submitted to Purchaser once a month containing : i) Progress on material procurement ii) Progress on fabrication (as applicable) iii) Progress on assembly (as applicable) iv) Progress on internal stage-inspection v) Reason for any delay in total programme vi) Details of test failures, if any, during manufacturing stages. vii) Progress on final box-up Constraints / Forward Path
10.0.0	<b>Deviation</b>	a) Deviations from this specification are only acceptable, where the Seller has listed in his quotation the requirements he cannot, or does not, wish to comply with, and the Buyer has accepted, in writing, the deviations before the order is placed. b) In the absence of any list of deviation, it will be assumed by the Buyer that the Seller complies fully with this specification.

**Annexure – A****Scope, Documentation and Delivery schedule****1. Scope**

A.	Scope	Design, manufacture, testing at manufacturer's works before dispatch, packing, delivery, unloading, stacking at stores/site of H.T. Power cables, as per Purchaser's BOQ (Bill of Quantity).
B.	Delivery Schedule	To be filled up on a case-to-case basis.

**a) Document Submission**

Submission of drawings, calculations, catalogues, manuals, test reports shall be as follows. (Also refer clause 5.0.0 – Drawings, Data and Manuals.)

Legend:

GTP : Guaranteed Technical Particulars

TTR : Type Test Report

RTR : Routine Test Report

[R4]

	Documents Along with offer	After award of contract - for Approval	Final documents (after Approval)
<b>GTP</b>	3 copies	** 1 soft copy	** 1 soft copy + CD
<b>Drawings</b>	3 copies	** 1 soft copy	** 1 soft copy + CD
<b>Calculations</b>	3 copies	** 1 soft copy	** 1 soft copy + CD
<b>Catalogues &amp; Manual</b>	1 copy each		** 1 soft copy + CD
<b>Test Report</b>	1 copy each of TTR and sample RTR		** 1 soft copy + CD

\*\* Soft copy and CD shall contain documents duly approved, signed and scanned.



**3. Delivery Schedule [R4]**

- a) Delivery period Start Date : from date of LOI / LOA
- b) Delivery period End Date : as agreed with supplier
- c) Material dispatch Clearance : after inspection by purchaser

## Annexure - B

**GUARANTEED TECHNICAL PARTICULARS  
(GTP) [R4]**
**Note:** [R4]

- 1) For every type / size of cable, every data shall be mentioned.
- 2) Seller may submit separate GTP for every type / size of cable, as suitable.
- 3) GTP requirements are generally as per IS : 7098 (Part-II).
- 4) GTP shall be read in line with purchaser's Project Site Specific Requirement.

Sr. No.	Description	Buyer's requirement	Unit	Seller's Data
1.0	Purchase Req. No.	-		
2.0	Guarantee Period (Min.)	60 Months (from date of commissioning) / 66 Months (from date of receipt at purchaser's store) whichever is earlier		
3.0	Applicable IS / IEC Standard followed by vendor	IS 7098 Part-2 / IEC 60502-2		
4.0	Make	-		
5.0	<b>Type</b> (as required by purchaser)	<b>[R4]</b>		
	a) 11 kV, 3c x 150 sq. mm.	A2XFY		
	b) 11 kV, 3c x 300 sq. mm.	A2XFY		
	c) 33 kV, 3c x 400 sq. mm.	A2XFY		
	d) 33 kV, 1c x 630 sq. mm.	A2XWaY		
	e) 11 kV, 1c x 1000 sq. mm.	A2XWaY		
	f) 33 kV, 1c x 1000 sq. mm.	A2XWaY		
6.0	<b>Voltage Grade</b>			
	a) 11 kV, 3c or 1c	6.35 / 11	kV	
	b) 33 kV, 3c or 1c	19 / 33	kV	
7.0	Maximum Conductor temperature			
A	Continuous	90	deg. C	
B	Short time	250	deg. C	
8.0	<b>Conductor</b>			
A	Material and Grade	As per Cl. 2.1.1		
B	Size	As shown under 5.0 above		

C	Wires in each conductor	As per Table 2 of IS 8130	Nos.	
D	Conductor Shape	As per Cl. 2.1.1 $\epsilon$		
E	Dia. of wires in each conductor before compaction	Manufacturer Standard	mm	
F	Diameter over conductor		mm	
G	Maximum Conductor resistance at 20 ° C			
	a) 11 kV, 3c x 150 sq. mm.	0.2060	ohm/km	
	b) 11 kV, 3c x 300 sq. mm.	0.1000	ohm/km	
	c) 33 kV, 3c x 400 sq. mm.	0.0778	ohm/km	
	d) 33 kV, 1c x 630 sq. mm.	0.0469	ohm/km	
	e) 11 kV, 1c x 1000 sq. mm.	0.0291	ohm/km	
	f) 33 kV, 1c x 1000 sq. mm.	0.0291	ohm/km	
H	Longitudinal Water Blocking Arrangement within conductor <b>[R4]</b>	Is it provided and shown in the cross-sectional drawing? (Yes / No)		
I	Short circuit current-carrying capacity of conductor		kA for 1 sec.	
9.0	<b>Conductor Screen</b> (inner semi-con)			
A	Material & type	As per Cl. 2.1.2		
B	Thickness (min) <b>[R4]</b>	0.50	mm	
C	Diameter over conductor screen		mm	
D	Make and grade of semi-conducting compound			
10.0	<b>Insulation</b>			
A	Insulation Material	As per Cl. 2.1.3		
B	Nominal thickness			
	a) 11 kV, 3c or 1c	3.6	mm	
	b) 33 kV, 3c or 1c	8.8	mm	
C	Minimum thickness			
	a) 11 kV, 3c or 1c	3.14	mm	
	b) 33 kV, 3c or 1c	7.82	mm	
D	Diameter over Insulation (Approx.)		mm	
E	Make and grade of Insulation compound			
F	Eccentricity <b>[R4]</b>	As per IEC standards	%	
G	Water-tree retardant property	Required <b>[R4]</b>		
11A.	<b>Insulation Screen</b> (outer semi-con)			

a.	i) Thickness of freely strippable Semi conducting screen	0.50	mm	
	ii) Make and grade of semi-conducting compound			
	iii) Printing	As per Cl. No. 2.1.4 (Yes / No)		
	iv) Ovality of the core [R4]	As per IEC Standards	%	
b.	Diameter over Insulation Screen (apprx.)		mm	
11B.	<b>Water-Swellable Tape</b> (if required by Purchaser)			
	a) Thickness b) Weight c) Swell height d) Compatible to strippable / non-strippable semi-con, over which it is applied. e) Make & Grade f) Pre-slitted packed tapes from sub-vendors approved by R-Infra [R4]	a) 0.3 mm b) 118 gm / sq. m c) $\geq 12$ mm in 1 min. d) Yes / No  e) Pl. state f) Yes / No		
11C.	<b>Cable Core identification</b>  a) By coloured strips over cores applied helically / longitudinally b) Manufacturer's name shall be permanently printed on the strips, at close intervals. [R4]			
11D.	<b>Copper Tape</b>			
	i) Dimensions	a) Thickness : 0.1 +/- 5 % b) Width : 50 mm  C) Overlap: 20% [R4]	Mm	
	ii) Fault current-carrying capacity of copper tape	Manufacturer's Standard (Calculation sheet shall be attached)	... kA for ... sec.	
11E.	Diameter over laid up core (apprx.)		mm	

12.0	<b>Filler</b> (Material and type)	As per Cl. 2.1.7 (Specify no. & size of filler at center & core interstices)		
	a) 11 kV, 3c x 150 sq. mm.			
	b) 11 kV, 3c x 300 sq. mm.			
	c) 33 kV, 3c x 400 sq. mm.	OFC Embedded (48 nos-36 single and 12 multi mode)		
	d) 11 kV or 33 kV, 1core	Not applicable		
12A.0	<b>Binder Tape</b>	over laid-up cores		
13.0	<b>Inner Sheath</b>			
A	Material and type	As per Cl. 2.1.9		
B	Minimum thickness			
	a) 11 kV, 3c x 150 sq. mm.	0.6	mm	
	b) 11 kV, 3c x 300 sq. mm.	0.7	mm	
	c) 33 kV, 3c x 400 sq. mm.	0.7	mm	
	d) 33 kV, 1c x 630 sq. mm.	0.6	mm	
	e) 11 kV, 1c x 1000 sq. mm.	0.7 [R4]	mm	
	f) 33 kV, 1c x 1000 sq. mm.	0.7	mm	
C	Approx. dia. over inner sheath		mm	
14.0	<b>Armour</b>	As per Manufacturer's Standard and as per purchaser's site- specific requirements		
A	Material			
	a) 11 kV, 3c	G. I. Strip	No.	
	b) 33 kV, 3c	G. I. Strip [R4]	No.	
	c) 11 kV or 33 kV, 1c	non-magnetic wire armour (Aluminium wire)	No.	
B	Armour – Wires	As per Table 4 of IS 7098 Part-2 (zero negative tolerance for diameter)		
	a) Diameter of wire		mm.	
	b) Number of wires (min.)		no.	

C	Armour – GI strips a) Width of strip & Thickness of strip  b) Number of strips (min.)	4 x 0.8 (zero negative tolerance for thickness)	mm  no.	
D	Approx. Equivalent Area		sq. mm.	
E	Area covered by armour	Min. 90 % Calculation shall be attached.	%	
F	Dia. over armour - apprx.		Mm	
G	Fault current carrying capacity of armour	Calculation sheet shall be attached.	... kA for ... sec.	
15.0	<b>Outer Sheath</b>			
A	Material and type	As per Cl. 2.2.12		
B	Thickness (min.)	** As per Table-5 of IS 7098 Part-2		
	a) 11 kV, 3c x 150 sq. mm.	**	mm	
	b) 11 kV, 3c x 300 sq. mm.	**	mm	
	c) 33 kV, 3c x 400 sq. mm.	**	mm	
	d) 33 kV, 1c x 630 sq. mm.	**	mm	
	e) 11 kV, 1c x 1000 sq. mm.	**	mm	
	f) 33 kV, 1c x 1000 sq. mm.	**	mm	
C	Color	Blue		
D	Embossing (details as per Cl. 2.1.12)	Yes / No		
E	FRLS Properties [R4]	As per customer's requirement		
16.0	Approx. overall diameter		mm	
17.0	Standard drum length with tolerance			
	a) 11 kV, 3c x 150 / 300 sq. mm.	300 +/- 5%	meters	
	b) 33 kV, 3c x 400 sq. mm.	200 +/- 5%	meters	
	c) 33 kV, 1c x 630 sq. mm.	500 +/- 5%	meters	
	d) 11 kV or 33 kV, 1c x 1000 sq. mm.	500 +/- 5%	meters	
17A	Overall order tolerance [R4]	+ / - 2 % for the total cable length for the entire order.		
18.0	<b>Cable Drum</b>			
a.	Type of drum	Steel		

		(Specify the relevant IS / IEC followed for drum design)		
b.	Markings on the drum (as per Cl. 7.0.0) [R4]	On both faces		
18A.0	<b>Cross-Sectional Drawing</b> (ref. Cl. 5.0.0) [R4]	Is drawing submitted, showing every feature of constructions? (Yes / No)		
19.0	<b>a. Pulling-eye Assembly</b> (provided at one running end) Refer drawing in Annexure-E [R4]	Is manufacturer's / Sub-vendor's drawing submitted? (Yes / No)		
	<b>b. Sealing-end Cap</b> (provided at the other end) Refer drawing in Annexure-E [R4]	Is manufacturer's / Sub-Vendor's drawing submitted? (Yes / No)		
20.0	<b>Weights</b>			
	a) Net weight of cable (apprx.)		kg / km	
	b) Weight of empty drum		Kg	
	c) Weight of Cable with drum		kg	
21.0	Continuous current rating for standard I. S. condition laid Direct			
	a) In ground 30° C		Amp	
	b) In duct 30° C		Amp	
	c) In air 40° C		Amp	
22.0	(not used)			
23.0	Electrical Parameters at Maximum Operating temperature:			
A	AC Resistance		ohm / km	
B	Reactance at 50 c/s		ohm / km	
C	Impedance		ohm / km	
D	Zero sequence impedance		ohm / km	
E	Positive sequence impedance		ohm / km	
F	Negative sequence impedance		ohm / km	
G	Capacitance		micro-farad / km	

24.0	Recommended minimum bending radius	--- x O. D.	mm	
25.0	De-rating factor for following Ambient Temperatures :	Ground / Air		
	a) At 30° C			
	b) At 35° C			
	c) At 40° C			
	d) At 45° C			
	e) At 50° C			
26.0	Group factor for following numbers of cables laid :	Touching Trefoil		
	a) 3 Nos.			
	b) 4 Nos.			
	c) 5 Nos.			
	d) 6 Nos.			
27.0	Recommended pressure for laying cable using power winch	30 N / mm <sup>2</sup>	N / sq. mm.	
28.0	Process of Cross-linking of Polyethylene			
	a) 11 kV, 3c or 1c	Dry Cure process only [R4]		
	b) 33 kV, 3c or 1c	Dry Cure process only		
29.0	<b>Type test</b> (TTR - Type Test Report)	Is copy of latest valid TTR for respective sizes enclosed? (Yes / No)		
30.0	<b>Quality Assurance Plan</b> (QAP) [R4]	Is QAP Format (Annexure-F), duly filled in and enclosed? (Yes / No)		
31.0	<b>List of Sub-Vendors</b> for construction items (Annexure-C) [R4]	Is this list enclosed for R-Infra approval? (Yes / No)		



**Annexure - C**
**List of Sub-Vendors  
for critical items**
**[R4]**

Vendor to state sub-vendors' names for other items, wherever approved names are not mentioned, for purchaser's approval during pre-order / post-order stages.

Ser. No.	Description of Material	R-Infra Approved @	Sub-Vendors
1.	TR-XLPE Compound	@	Dow Chemicals , U.S.A.
		@	Borealis , Sweden
		@	Hanwha , Seoul , South Korea
2.	Semi-Conducting Compound	@	Dow Chemicals , U.S.A.
		@	Borealis , Sweden
		@	Hanwha , Seoul , South Korea
3.	Conductor Water-Blocking tapes / yarn / powder	@	Lantor
		@	Geca
		@	Freudenberg
		@	Scapa
4.	Water-Swellable Tapes (Pre-slitted)	@	Lantor
		@	Geca
		@	Freudenberg
		@	Scapa
		@	Miracle
		@	Tekstilna (Slovenia)
5.	E.C. Grade Aluminium Rod	@	Bharat Aluminium Co. Ltd. (BALCO)
		@	Hindustan Aluminium Co. Ltd. (HINDALCO)
		@	National Aluminium Co. Ltd. (NALCO)

6.	Aluminium Alloy		
7.	E.C. Grade Copper Rod		
8.	H.T.G.S. Wire		
9.	PVC Compound		
10.	PVC Resin		
11.	Galvanised Steel Wires / Strips		
12.	Copper Tape (for screening)		
13.	P. P. Fillers		

**Annexure - D****Service Conditions [R4]**

(Atmospheric / Soil conditions at Site)

<b>A. Mumbai</b>		
a)	Average grade atmospheric condition	Heavily polluted, salt-laden, dusty, humid with possibility of condensation
b)	Average grade soil condition	Water-logged
c)	Maximum altitude above sea level	1000 M
d)	Ambient Air temperature	i) Highest : 45 deg C ii) Average : 35 deg C iii) Minimum : 15 deg C
e)	Relative Humidity	100 % Max
f)	Thermal Resistivity of Soil	150 deg. C . cm / W max.
g)	Seismic Zone	3
h)	Rainfall	3000 mm concentrated in four months

<b>B. Delhi</b>		
a)	Average grade atmospheric condition	Heavily polluted, dry
b)	Average grade soil condition	
c)	Maximum altitude above sea level	1000 M
d)	Air temperature Ambient	i) Highest : 50 deg C ii) Average : 40 deg C iii) Minimum : 0 deg C
e)	Relative Humidity	100 % max
f)	Thermal Resistivity of Soil	150 deg. C . cm / W max.
g)	Seismic Zone	4
h)	Rainfall	750 mm concentrated in four months

**Annexure E**

1. **General Arrangement Drawing for  
Cable Pulling Eye  
[R4]**
  
2. **General Arrangement Drawing for  
End-sealing Cap  
[R4]**

Both the above drawings are given on next pages.

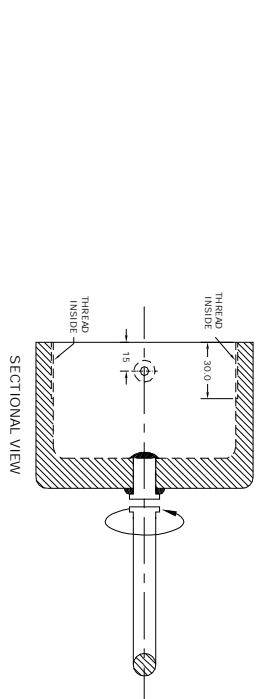
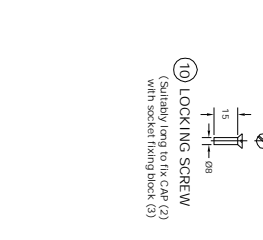
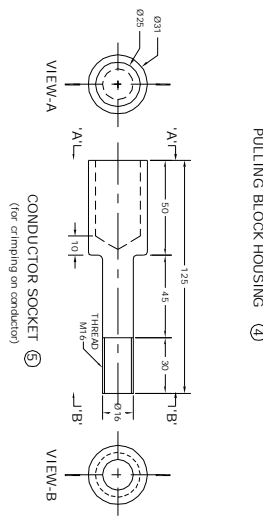
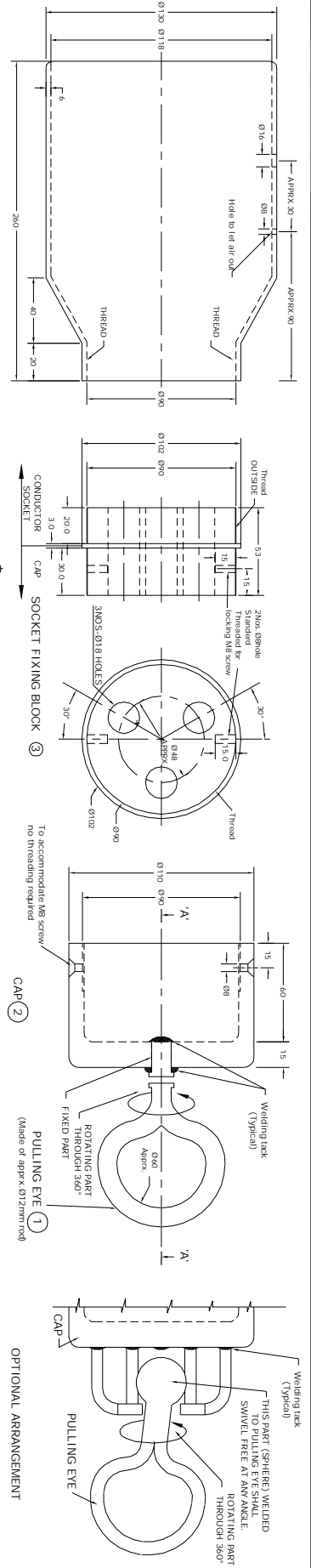

**Exploded View**

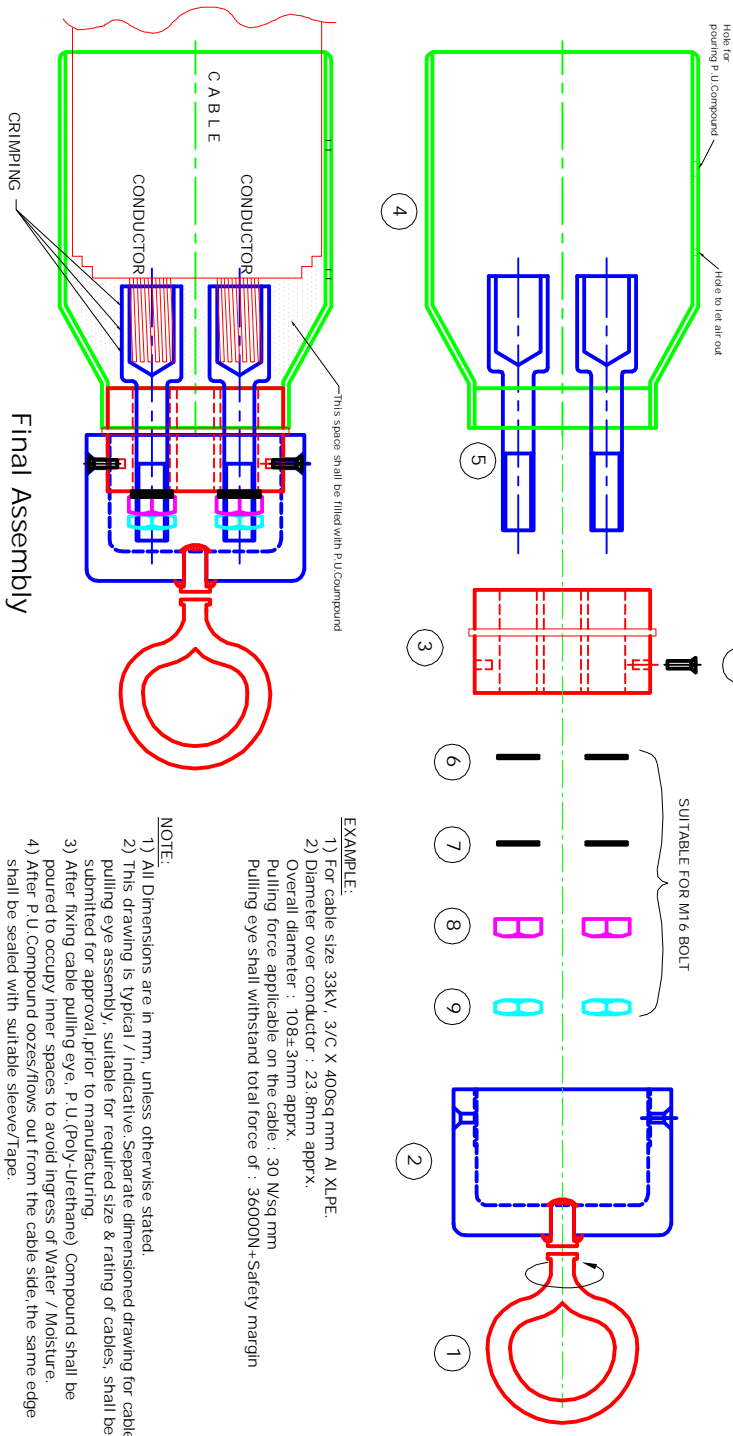

**Final Assembly**

- EXAMPLE:**
- 1) For cable size 33kV, 3/C X 400sq mm AL XLPE.
  - 2) Diameter over conductor : 23.8mm approx.
  - Overall diameter : 108±3mm approx.
  - Pulling force applicable on the cable : 30 N/sq mm
  - Pulling eye shall withstand total force of : 36000N±Safety margin

- NOTE:**
- 1) All Dimensions are in mm, unless otherwise stated.
  - 2) This drawing is typical / indicative. Separate dimensioned drawing for cable pulling eye assembly, suitable for required size & rating of cables, shall be submitted for approval, prior to manufacturing.
  - 3) After fixing cable pulling eye, P.U. (Poly-Urethane) Compound shall be poured to occupy inner spaces to avoid ingress of Water / Moisture.
  - 4) After P.U. Compound cures/flows out from the cable side, the same edge shall be sealed with suitable sleeve/Tape.

NO.	DISCRIPTION	QTY	MATERIAL
1	PULLING EYE	1	M.S.Zinc-Plated
2	CAP	1	M.S.Zinc-Plated
3	SOCKET FIXING BLOCK	1	M.S.Zinc-Plated
4	PULLING BLOCK HOUSING	1	M.S.Zinc-Plated
5	CONDUCTOR SOCKET	3	AL.
6	PLAIN WASHER	3	M.S.Zinc-Plated
7	SPRING WASHER	3	M.S.Zinc-Plated
8	NUT	3	M.S.Zinc-Plated
9	LOCK NUT	3	M.S.Zinc-Plated
10	LOCKING SCREW	2	M.S.Zinc-Plated



**DRAWING No.** M/SC/E/4-1133/1699  
**SCALE** NOT TO SCALE  
**DATE** 09-05-2011

**CABLE PULLING EYE ASSEMBLY (TYPICAL)**

DRAWN BY:	CHECKED BY:	APPROVED BY:
REVISIONS	REVISIONS	REVISIONS

## DIMENSIONS

SIZE	A	A	B	C	D	LC %	T
	EXP.(Min.)	REC.(Max)	EXP.(Min.)	EXP.(Min.)	EXP.(Min.)		(WALL REC. ± 20 %)
EC 120/150	75	34	120	105	50	± 10	4.2
EC 240/300	100	62	130	110	70	± 10	3.5
EC 400	145	75	155	120	70	± 10	4.6

EXP - Expanded (as supplied), REC - Recovered freely, LC - Longitudinal Change, T - Wall Thickness, EC - End Cap

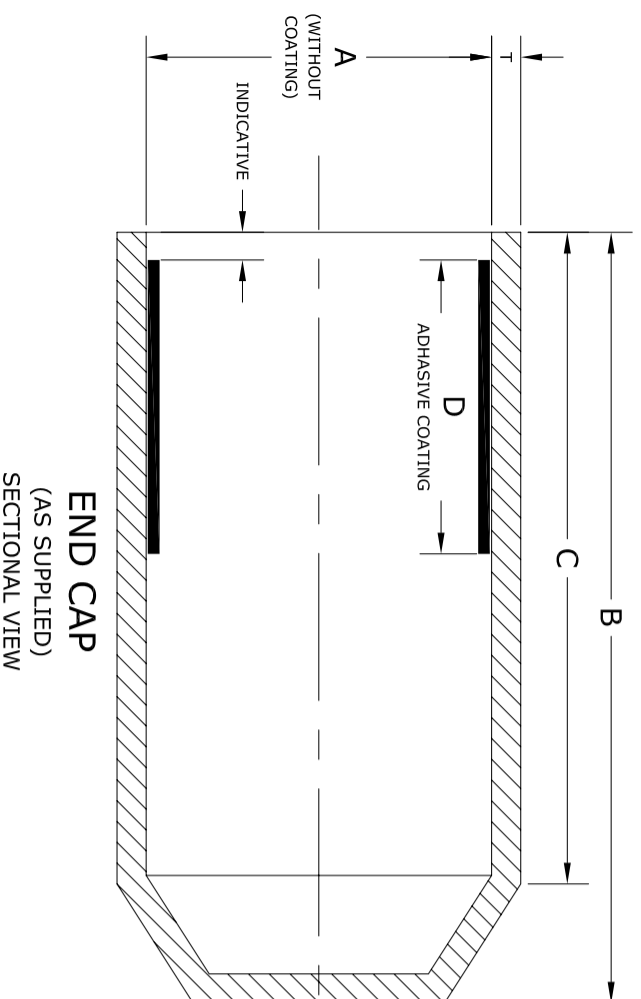

## MATERIAL SPECIFICATIONS

Characteristics	Test Class	Value	Test Method
<b>A Physical Properties</b>			
1 Specific Gravity	Type	1.05 ± 0.2	ASTM D -1505
2 Water Absorption	Type	1 % (max)	ASTM D-570 / ISO 62
3 Tensile Strength	Routine	10 N /sqmm (min)	ASTM D-412 / ISO 37
4 Ultimate Elongation	Routine	300% (min)	ASTM D-412 / ISO 37
5 Hardness	Type	45 shore D ± 3	ASTM D -2240
<b>6 Thermal Test</b>			
<b>B Thermal Ageing (120°C for 500 hrs)</b>			
1 Tensile Strength	Type	8 N/sqmm (min)	ASTM D-412 / ISO 37
2 Ultimate Elongation	Type	200% (min)	ASTM D-412 / ISO 37
<b>C Electrical Properties</b>			
1 Volume Resistivity	Type	10 <sup>12</sup> ohm-cm. (min)	ASTM D-257 / IEC 93
2 Dielectrical Strength	Type	10 kV/mm. (min)	ASTM D-149 / IEC 243
3 Dielectric Constant	Type	5 (max)	ASTM D-150 / IEC 250

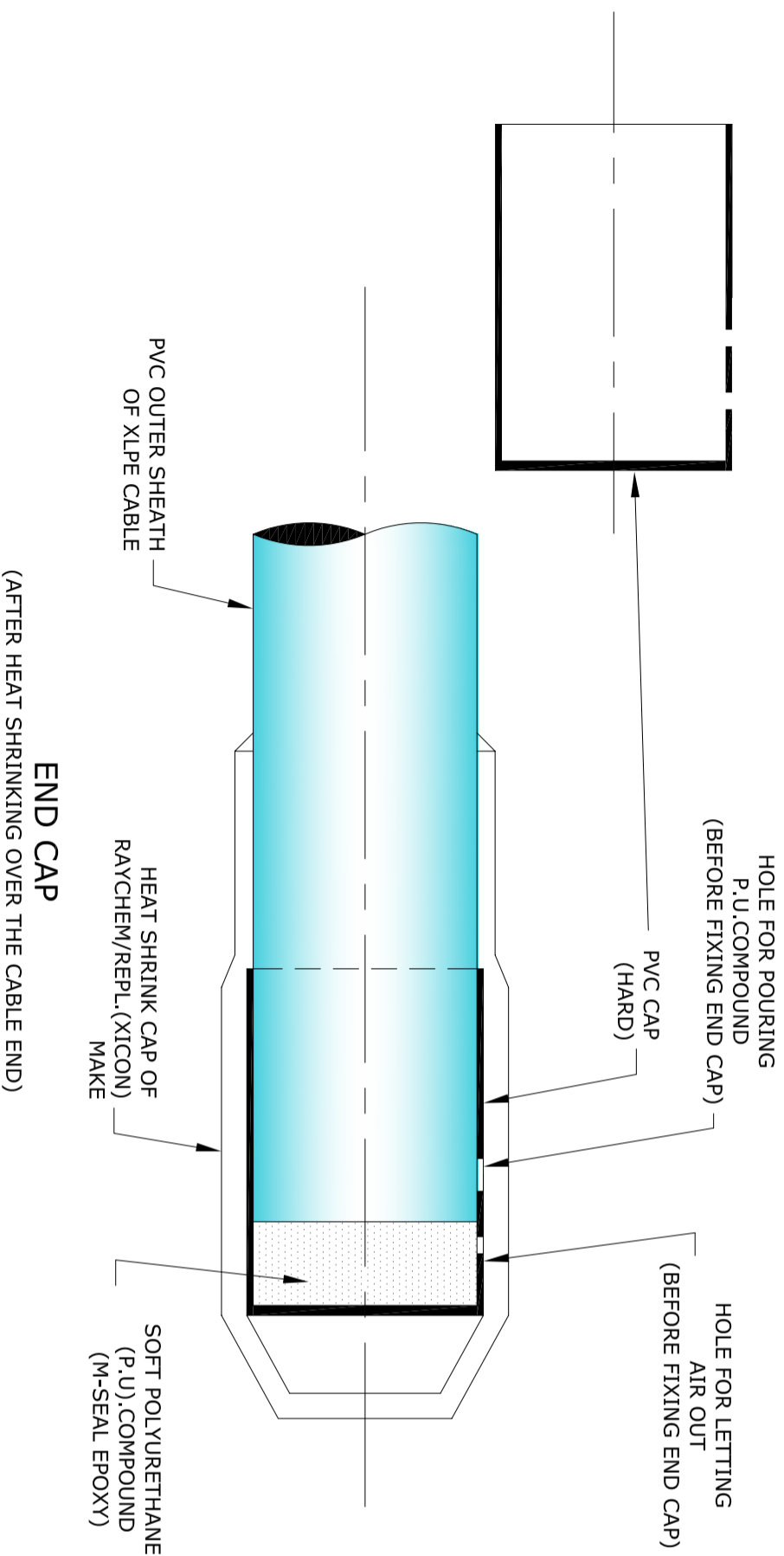

- Note : 1) All dimension in mm  
2) Colour Black  
3) Size as mentioned in the table shall be stencilled on respective item

**RELIANCE**

DRAWING No. MISC/E/4-1131/1698

SCALE :NOT TO SCALE DATE: 09-05-2011

**END SEALING CAP**  
(FOR XLPE CABLE)

DRAWN BY: BJR CHECKED BY: AP/DS/PS APPROVED BY:

REVISIONS

**Annexure- F****QAP Format  
(Quality Assurance Plan)  
For H. T. Cables (Typical)  
(Page 1 to 10)  
[R4]**

Typical Characteristics are mentioned in the above QAP format, which is appearing on the next pages.

Vendor shall submit the QAP, duly filled in, in accordance with IS / IEC standards and manufacturer's standards/procedures, for Purchaser's approval, during pre-order / post-order stages.



**QUALITY ASSURANCE PLAN (QAP)  
FOR H. T. CABLES  
(Typical Format)**

09.03.2012

Legend : SV : Sub-Vendor of Cable Manufacturer, MFR : Cable Manufacturer, R-Infra : Reliance Infra-Structure Ltd., PS : Purchase Specification of Cable Vendor, R-Infra Spec. - R-Infra Specification  
P - Perform , V - Verify , W - Witness

Sr. No.	COMPONENT		CHARACTERISTICS & OPERATIONS	UNIT	CLASS	Measuring Equipment / Technique	TYPE OF CHECK	QUANTUM OF CHECK	REFERENCE DOCUMENT / TEST	ACCEPTANCE NORMS	FORMAT OF RECORD	AGENCY			Remarks		
												SV	MFR	R-Infra			
1	2	3	4	5	6	7	8	9	10	11	12	13	14	15	16	17	
<b>A. RAW MATERIALS</b>																	
1	Aluminium / Copper Rod	a)	Tensile strength	kg									P	P/V	V/W		
		b)	Resistivity at 20 Deg C	ohm-mm <sup>2</sup> /km										P	P/V	V/W	
		c)	Diameter	mm										P	P/V	V/W	
		d)	Chemical composition											P	V	V	
		e)	Surface finish	--										P	P	V/W	
		f)	Purity of Aluminium / Copper						One sample per PO					P	P	V/W	
2	PVC Compound	a)	Tensile Strength	N/sq.mm.									P	P/V	V		
		b)	Elongation at break	%									P	P/V	V		
		c)	Thermal stability	min.									P	P/V	V		
		d)	Additional test (for FRLS Sheathing compound only)														
		i)	Oxygen Index test											P	P/V	V	
		ii)	Temperature Index test											P	P/V	V	
		iii)	Smoke generation test											P	P/V	V	
		iv)	Acid gas generation test											P	P/V	V	
3	TR-XLPE Compound	a)	Packing										P	V	V		
		b)	Tensile Strength	N/sq.mm.									P	P/V	V		
		c)	Elongation at break	%									P	P/V	V		
		d)	Hot set test	%									P	P/V	V		
		e)	Volume Resistivity	ohm-cm									P	P/V	V		
		f)	Cure Curve (Max. Torque)	lb-in									-	P	V		
		g)	Density	g/cc									P	P/V	V		
4	Semi-conducting Compound	a)	Packing										P	V	V		
		b)	Volume Resistivity										P	P/V	V		
		c)	Tensile Strength	N/sq.mm.									P	P/V	V		
		d)	Elongation at break	%									P	P/V	V		
		e)	Cure Curve (Max. Torque)	lb-in									-	P	V		
		f)	Density	g/cc									P	P/V	V		
		g)	Firmly bonded over conductor										P	P/V	V		
		h)	Easily strippable over XLPE insulation										P	P/V	V		
5	Copper Tape	a)	Thickness & width	mm x mm									P	P/V	V		
		b)	Tensile Strength	N/sq.mm.									P	P/V	V		
		c)	Elongation at break	%									P	P/V	V		
		d)	Resistivity	ohm-mm <sup>2</sup> /km									P	P/V	V		





**QUALITY ASSURANCE PLAN (QAP)  
FOR H. T. CABLES  
(Typical Format)**

09.03.2012

Legend : SV : Sub-Vendor of Cable Manufacturer, MFR : Cable Manufacturer, R-Infra : Reliance Infra-Structure Ltd., PS : Purchase Specification of Cable Vendor, R-Infra Spec. - R-Infra Specification  
P - Perform , V - Verify , W - Witness

Sr. No.	COMPONENT		CHARACTERISTICS & OPERATIONS	UNIT	CLASS	Measuring Equipment / Technique	TYPE OF CHECK	QUANTUM OF CHECK	REFERENCE DOCUMENT / TEST	ACCEPTANCE NORMS	FORMAT OF RECORD	AGENCY			Remarks		
												SV	MFR	R-Infra			
1	2	3	4	5	6	7	8	9	10	11	12	13	14	15	16	17	
6	Armour wires/strips (Galvanised Steel)	a)	Dimensions	mm x mm									P	P/V	V		
		b)	Surface condition/finish	--										P	P/V	V	
		c)	Tensile Strength	N/sq.mm.										P	P/V	V	
		d)	Elongation at break	%										P	P/V	V	
		e)	Torsion test for round wire											P	P/V	V	
		f)	Wrapping test											P	P/V	V	
		g)	Mass of zinc coating	g/sq.m.										P	P/V	V	
		h)	Uniformity of zinc coating	dips										P	P/V	V	
		i)	Adhesion test											P	P/V	V	
		j)	Resistivity test	ohm-mm <sup>2</sup> /km										P	P/V	V	
7	Water Swellable Tape (Non-Woven)	a)	Dimensions	mm x mm									P	P/V	V		
		b)	Swelling height	mm									P	P/V	V		
		c)	Resistivity										P	P/V	V		
		d)	Mass	g/sq.m.									P	P/V	V		
8	Steel Drum	a)	Dimension	mm						As per IS			P	P	V		
		b)	Finish & workman ship	--									P	P	V		
9	Cable Pulling Eye	a)	Dimensions & Material	mm						R-Infra approved drawing			P	P	V		
		b)	Finish & workman ship	--									P	P	V		
		c)	Tension test on pulling eye	N/sq.mm.						R-Infra approved drawing			P	P	V		
10	Binder Tape		Dimensions & material	mm								P	P	V			
11	Poly-propylene Net Filler		Size									P	P	V			
12	Heat-shrinkable End Cap	a)	Bore diameter	mm						R-Infra approved drawing			-	P	V		
		b)	Length of end cap	mm						R-Infra approved drawing			-	P	V		
		c)	hot melt adhesive														
<b>B. IN-PROCESS INSPECTION</b>																	
1	Wire Drawing	a)	Diameter	mm									-	P	V/W		
		b)	Surface finish	--										-	P	V/W	
		c)	Tensile test (for Al)	N/sq.mm.						IS: 8130/84	IS: 8130/84			-	P	V/W	
		d)	Elongation test (for Cu)							IS: 8130/84	IS: 8130/84			-	P	V/W	
		e)	Wrapping test (for Al)							IS: 8130/84	IS: 8130/84			-	P	V/W	
		f)	D.C. Resistance at 20 deg C	ohm-cm											P	V/W	
2	Stranding	a)	No. of wires/strands	no.									-	P	V		
		b)	Lay length & Lay direction	mm										-	P	V	
		c)	Dia of conductor	mm										-	P	V	
		d)	Surface finish	--										-	P	V	
		e)	Mass of conductor	kg								IS 8130/84		-	P	V	



**QUALITY ASSURANCE PLAN (QAP)  
FOR H. T. CABLES  
(Typical Format)**

09.03.2012

Legend : SV : Sub-Vendor of Cable Manufacturer, MFR : Cable Manufacturer, R-Infra : Reliance Infra-Structure Ltd., PS : Purchase Specification of Cable Vendor, R-Infra Spec. - R-Infra Specification  
P - Perform , V - Verify , W - Witness

Sr. No.	COMPONENT	CHARACTERISTICS & OPERATIONS				UNIT	CLASS	Measuring Equipment / Technique	TYPE OF CHECK	QUANTUM OF CHECK	REFERENCE DOCUMENT / TEST	ACCEPTANCE NORMS	FORMAT OF RECORD	AGENCY			Remarks	
		3	4	5	6									7	8	9		10
3	<b>Core Extrusion (CCV)</b>  <b>Conductor Screen</b>  + <b>Insulation (XLPE with water-tree retardant property)</b>  + <b>Insulation Screen</b>	a)		Compound Make/Grade	--								-	-	P	V		
b)			i) Thickness of Conductor Screen ii) Thickness of Insulation iii) Thickness of Insulation Screen	mm						IS 7098 (Part 2) / 85	IS 7098 (Part 2) / 85			-	P	V		
c)			Surface finish	--										-	P	V		
d)			Printing on outer semi-conducting layer								"DO NOT HEAT, FREELY STRIPPABLE"			-	P	V		
e)			Tensile Strength								IS 7098(Part 2)/85	IS 7098(Part 2)/85			-	P	V	
f)			Elongation at break								IS 7098(Part 2)/85	IS 7098(Part 2)/85			-	P	V	
g)			Hot set test			%					IS 7098(Part 2)/85	IS 7098(Part 2)/85			-	P	V	
h)			Eccentricity of insulation			%									-	P	V	
i)			Core diameter and Ovality check on core			mm									-	P	V	
j)			Void & contamination test for insulation (Silicon Oil test)			no.									-	P	V/W	
k)			Condition of Triple Extrude												-	P	V/W	
l)			CCV tube pressure (N2) and temperature			bars & deg. C									-	P	V/W	
m)			Temperature of Extruder (65 mm, 80 mm, 150 mm)			deg C									-	P	V/W	
n)			Haul off / Line Speed			m/min									-	P	V/W	
o)			Dimensions and Condition of dies & nipple			mm									-	P	V/W	
p)			Freely strippable insulation screen (Strippability Test)								IS:7098/3, 93 Cl. No. 20	IS:7098/3, 93 Cl. No. 20			-	P	V/W	
q)			Water boil test for extruded semi-conducting layers								BIS draft Specn	BIS draft Specn			-	P	V/W	
r)		Longitudinal Water-Blocking Test								IEC 60502-2	IEC 60502-2			-	P	V/W		
4	<b>Water Swellable Semi-conducting</b>	a)		Dimensions (thickness x width)	mm x mm									-	P	V		
b)			Tape Application (Overlap)	%										-	P	V		
c)			Lay direction	--														
5	<b>Copper Tape - taping</b>	a)		Diameter under copper tape	mm									-	P	V		
b)			Dimensions (thickness x wid	mm x mm										-	P	V		
c)			Number of tapes											-	P	V		
d)			Tape application (Overlap)			%								-	P	V		
e)			Diameter over copper tape			mm								-	P	V		
6	<b>Laying up</b>	a)		Identification of cores	--									-	P	V		
b)			Direction of lay & core sequence	Measuring tape							IS 7098(Part 2)/85	IS 7098(Part 2)/85			-	P	V	
c)			Lay length			Scale								-	P	V		
d)			Shape of laid up assembly			--								-	P	V		
e)			P. P. Filler size			mm								-	P	V		
f)			Diameter over Lay-up			mm								-	P	V		



**QUALITY ASSURANCE PLAN (QAP)  
FOR H. T. CABLES  
(Typical Format)**

09.03.2012

Legend : SV : Sub-Vendor of Cable Manufacturer, MFR : Cable Manufacturer, R-Infra : Reliance Infra-Structure Ltd., PS : Purchase Specification of Cable Vendor, R-Infra Spec. - R-Infra Specification  
P - Perform , V - Verify , W - Witness

Sr. No.	COMPONENT	CHARACTERISTICS & OPERATIONS			UNIT	CLASS	Measuring Equipment / Technique	TYPE OF CHECK	QUANTUM OF CHECK	REFERENCE DOCUMENT / TEST	ACCEPTANCE NORMS	FORMAT OF RECORD	AGENCY			Remarks	
		3	4	5									6	7	8		9
7	Inner Sheath	a)		Material & type	--								-	P	V		
		b)		Thickness	mm				IS 7098(Part 2) / 85	IS 7098(Part 2) / 85			-	P	V		
		c)			Surface finish	--								-	P	V	
		d)			Colour of inner sheath	--								-	P	V	
		e)			Diameter over Inner Sheath	mm								-	P	V	
8	Armouring	a)		Dimension of wires/strips	mm								-	P	V		
		b)		No. of wires/strip	no.									-	P	V	
		c)			Armour coverage	%				IS 7098(Part 2)/85	IS 7098(Part 2)/85			-	P	V	
		d)			Direction of lay	--				IS 7098(Part 2)/85	IS 7098(Part 2)/85			-	P	V	
		e)			Lay length/Gear setting	mm								-	P	V	
		f)			Surface finish	--								-	P	V	
		g)			Diameter over Armour	mm								-	P	V	
		h)			Rubberised cotton tape over armour	--								-	P	V	
9	Outer Sheath	a)		Material & type	--							-	-	P	V		
		b)		Anti termite additives	--								-	-	P	V	
		c)			Thickness	mm								-	P	V	
		d)			Overall diameter of the Cable	mm								-	P	V	
		e)			Surface finish & colour of sheath	--								-	P	V	
		f)			Cable length verification	--								-	P	V	
		g)			Embossing / Printing / Sequential Marking	--				As per R-Infra's approved GTP/Cross-sectional drawing				-	P	V	
10	Cable Winding over the drum	a)		Cable appearance	--								-	P	V		
		b)		Ovality check over completed cable	--									-	P	V	
		c)			Drum appearance, including fixing of M. S. Spindle Plates	--								-	P	V	
		d)			Winding	--								-	P	V	
		e)			Packing	--								-	P	V	
		f)			Embossing / Printing	--								-	P	V	
		g)			Surface finish	--								-	P	V	
<b>C. TESTING &amp; INSPECTION</b>																	
1.	Type Tests	<b>Type Tests at Vendor's works</b>															
		a)	<b>Tests on conductor</b>														
																	One sample
			i)		Annealing test for copper					IS 8130/84	IS 8130/84				-	P	V
			ii)		Tensile test for aluminium	N/mm <sup>2</sup>				IS 8130/84	IS 8130/84				-	P	V
		iii)		Wrapping test for aluminium					IS 8130/84	IS 8130/84				-	P	V	
		iv)		Conductor resistance test	ohm/km				IS 8130/84	IS 8130/84				-	P	V/W	



**QUALITY ASSURANCE PLAN (QAP)  
FOR H. T. CABLES  
(Typical Format)**

09.03.2012

Legend : SV : Sub-Vendor of Cable Manufacturer, MFR : Cable Manufacturer, R-Infra : Reliance Infra-Structure Ltd., PS : Purchase Specification of Cable Vendor, R-Infra Spec. - R-Infra Specification  
P - Perform , V - Verify , W - Witness

Sr. No.	COMPONENT	CHARACTERISTICS & OPERATIONS		UNIT	CLASS	Measuring Equipment / Technique	TYPE OF CHECK	QUANTUM OF CHECK	REFERENCE DOCUMENT / TEST	ACCEPTANCE NORMS	FORMAT OF RECORD	AGENCY			Remarks	
		3	4									SV	MFR	R-Infra		
1	2	3	4	5	6	7	8	9	10	11	12	13	14	15	16	17
		b)		<b>Tests on armouring wires/strips</b>					One sample							
		i)		Dimensions of wire/strip	mm					IS 3975, IS 10810 Pt. 36			-	P	V/W	
		ii)		Tensile strength & Elongation at break	N/mm2					IS 3975	IS 3975		-	P	V/W	
		iii)		Torsion test for round wire						IS 3975	IS 3975		-	P	V/W	
		iv)		Winding test for strip (Wrapping Test for Al wires/formed wires only)						IS 3975	IS 3975		-	P	V/W	
		v)		Uniformity of zinc coating (for GS)	dips					IS 3975	IS 3975		-	P	V/W	
		vi)		Mass of zinc coating (for GS)	g/mm2					IS 3975	IS 3975		-	P	V/W	
		vii)		Adhesion Test						IS	IS		-	P	V/W	
		viii)		Resistivity of wire/strip	ohm-cm					IS 3975	IS 3975		-	P	V/W	
		c)		Test for thickness of insulation & sheath	mm				One sample	IS 7098(Part 2)/85			-	P	V/W	
		d)		<b>Physical tests on insulation</b>					One sample							
		i)		Tensile strength & Elongation test (before and after ageing)	N/mm2, %					IS 7098(Part 2)/85	IS 7098(Part 2)/85		-	P	V/W	
		ii)		Ageing in air oven						IS 7098(Part 2)/85	IS 7098(Part 2)/85		-	P	V/W	
		iii)		Hot set test	%					IS 7098(Part 2)/85	IS 7098(Part 2)/85		-	P	V/W	
		iv)		Shrinkage test						IS 7098(Part 2)/85	IS 7098(Part 2)/85		-	P	V/W	
		v)		Water absorption test (gravimetric)						IS 7098(Part 2)/85	IS 7098(Part 2)/85		-	P	V/W	
		vi)		Eccentricity test									-	P	V/W	
		e)		<b>Physical tests on outer sheath</b>					One sample							
		i)		Tensile strength & Elongation test at break (before and after ageing)						IS 5831/84	IS 5831/84		-	P	V/W	
		ii)		Ageing in air oven						IS 5831/84	IS 5831/84		-	P	V/W	
		iii)		Shrinkage test	%					IS 5831/84	IS 5831/84		-	P	V/W	
		iv)		Hot deformation test						IS 5831/84	IS 5831/84		-	P	V/W	
		v)		Loss of mass test in air oven						IS 5831/84	IS 5831/84		-	P	V/W	
		vi)		Heat shock test						IS 5831/84	IS 5831/84		-	P	V/W	
		vii)		Thermal stability test	deg C, time					IS 5831/84	IS 5831/84		-	P	V/W	
		viii)		Cold Bend Test						IS 5831/84	IS 5831/84		-	P	V/W	
		ix)		Cold Impact Test						IS 5831/84	IS 5831/84		-	P	V/W	



**QUALITY ASSURANCE PLAN (QAP)  
FOR H. T. CABLES  
(Typical Format)**

09.03.2012

Legend : SV : Sub-Vendor of Cable Manufacturer, MFR : Cable Manufacturer, R-Infra : Reliance Infra-Structure Ltd., PS : Purchase Specification of Cable Vendor, R-Infra Spec. - R-Infra Specification  
P - Perform , V - Verify , W - Witness

Sr. No.	COMPONENT	CHARACTERISTICS & OPERATIONS			UNIT	CLASS	Measuring Equipment / Technique	TYPE OF CHECK	QUANTUM OF CHECK	REFERENCE DOCUMENT / TEST	ACCEPTANCE NORMS	FORMAT OF RECORD	AGENCY			Remarks	
		3	4	5									6	7	8		9
		f)		<b>Electrical Tests</b>					One sample								
		i)		Partial discharge test	pC					IS 7098(Part 2)/85	IS 7098(Part 2)/85		-	P	V/W		
		ii)		Bending test						IS 7098(Part 2)/85	IS 7098(Part 2)/85		-	P	V/W		
		iii)		Partial discharge test	pC					IS 7098(Part 2)/85	IS 7098(Part 2)/85		-	P	V/W		
		iv)		Dielectric power factor test (as a function of voltage)						IS 7098(Part 2)/85	IS 7098(Part 2)/85		-	P	V/W		
		v)		Dielectric power factor test (as a function of temperature)						IS 7098(Part 2)/85	IS 7098(Part 2)/85		-	P	V/W		
		vi)		Heating cycle test	deg C, hrs., nos.					IS 7098(Part 2)/85	IS 7098(Part 2)/85		-	P	V/W		
		vii)		Dielectric power factor as a function of voltage						IS 7098(Part 2)/85	IS 7098(Part 2)/85		-	P	V/W		
		viii)		Partial discharge test	pC					IS 7098(Part 2)/85	IS 7098(Part 2)/85		-	P	V/W		
		ix)		Impulse withstand test						IS 7098(Part 2)/85	IS 7098(Part 2)/85		-	P	V/W		
		x)		High voltage test	kV, min.					IS 7098(Part 2)/85	IS 7098(Part 2)/85		-	P	V/W		
		g)		Insulation Resistance test (Volume Resistivity test)	ohm-cm				One sample	IS 7098(Part 2)/85	IS 7098(Part 2)/85		-	P	V/W		
		h)		Flammability Test					One sample	IS 7098(Part 2)/85	IS 7098(Part 2)/85		-	P	V/W		
		i)		Water Penetration Test (WPT) on core (Longitudinal Water-Blocking test)					One sample	IEC 60502-2	IEC 60502-2		-	P	V/W		
		j)		Freely strippable insulation screen (Strippability Test)									-	P	V/W		
		k)		Ovality check on core									-	P	V/W		
		l)		Ovality check on completed Cable									-	P	V/W		
		m)		Check on fixing of M.S. Spindle Plates									-	P	V/W		
		o)		Additional tests on FRLS-type cables only													
		1)		Tests on FRLS outer sheath					One sample								
				i) Oxygen Index test									-	P	V		
				ii) Temperature Index test									-	P	V		
				iii) Acid gas generation test									-	P	V		
				iv) Smoke density test									-	P	V		
		2)		Flammability test on a piece of completely ready FRLS cable					One sample	IS 7098 (Part 2)/85 / IEC 332 (Part 3- Category B)	IS 7098 (Part 2)/85		-	P	V/W		



**QUALITY ASSURANCE PLAN (QAP)  
FOR H. T. CABLES  
(Typical Format)**

09.03.2012

Legend : SV : Sub-Vendor of Cable Manufacturer, MFR : Cable Manufacturer, R-Infra : Reliance Infra-Structure Ltd., PS : Purchase Specification of Cable Vendor, R-Infra Spec. - R-Infra Specification  
P - Perform , V - Verify , W - Witness

Sr. No.	COMPONENT	CHARACTERISTICS & OPERATIONS			UNIT	CLASS	Measuring Equipment / Technique	TYPE OF CHECK	QUANTUM OF CHECK	REFERENCE DOCUMENT / TEST	ACCEPTANCE NORMS	FORMAT OF RECORD	AGENCY			Remarks
		3	4	5									6	7	8	
2.	<b>Routin Tests</b>	a)	High Voltage		kV, min.				100 %	IS 7098(Part 2)/85	IS 7098(Part 2)/85		-	P	V	
		b)	Conductor Resistance		ohm/km				100 %	IS 8130/84	IS 8130/84		-	P	V	
		c)	Partial Discharge		pC				100 %	IS 7098(Part 2)/85	IS 7098(Part 2)/85		-	P	V	
		d)	Freely strippable insulation screen (Strippability Test)										-	P	V	
3.	<b>Acceptance Tests</b>	a)	Annealing test for copper							IS 8130/84	IS 8130/84		-	P	V	
		b)	Tensile test for aluminium							IS 8130/84	IS 8130/84		-	P	V	
		c)	Wrapping test for aluminium							IS 8130/84	IS 8130/84		-	P	V	
		d)	Conductor resistance test		ohm/km					IS 8130/84	IS 8130/84		-	P	W	
		e)	Test for thickness of insulation & sheath					Appendix A to IS 7098(Part 2)/85		IS 7098(Part 2)/85	IS 7098(Part 2)/85		-	P	W	
		f)	Eccentricity test on insulation													
		g)	Hot set test for insulation		%					IS 7098(Part 2)/85	IS 7098(Part 2)/85		-	P	W	
		h)	Tensile strength & Elongation at break of insulation & outer sheath		N/mm2, %					IS 7098 (Part 2 ) / 85 & IS 5831/84 (Type ST2)			-	P	W	
		i)	Partial discharge test		pC					IS 7098(Part 2)/85	IS 7098(Part 2)/85		-	P	W	
		j)	High voltage test		kV, min.					IS 7098(Part 2)/85	IS 7098(Part 2)/85		-	P	W	
		k)	Insulation resistance (Volume resistivity) test		ohm-cm			Appendix A to IS 7098(Part 2)/85		IS 7098(Part 2)/85	IS 7098(Part 2)/85		-	P	W	
		l)	Tests for dimension and number of armour wires/strips		mm					IS 3975, IS 10810 Pt. 36			-	P	W	
		m) i)	Test for anti-termite property of outer sheath										-	P	W	
		ii)	Test for anti-rodent property of outer sheath										-	P	W	
		n)	Winding of cable on drum To check : i) cable appearance ii) drum appearance iii) cable winding iv) packing v) embossing / printing vi) length verification vii) mass of cable viii) ovality check on completed cable x) Fixing of M. S. Plates					One drum from offered lot					-	P	W	



**QUALITY ASSURANCE PLAN (QAP)  
FOR H. T. CABLES  
(Typical Format)**

09.03.2012

Legend : SV : Sub-Vendor of Cable Manufacturer, MFR : Cable Manufacturer, R-Infra : Reliance Infra-Structure Ltd., PS : Purchase Specification of Cable Vendor, R-Infra Spec. - R-Infra Specification  
P - Perform , V - Verify , W - Witness

Sr. No.	COMPONENT			CHARACTERISTICS & OPERATIONS	UNIT	CLASS	Measuring Equipment / Technique	TYPE OF CHECK	QUANTUM OF CHECK	REFERENCE DOCUMENT / TEST	ACCEPTANCE NORMS	FORMAT OF RECORD	AGENCY			Remarks	
													SV	MFR	R-Infra		
1	2	3	4	5	6	7	8	9	10	11	12	13	14	15	16	17	
				o) Water Boil test to check the integrity of semiconducting layer					Appendix A to IS 7098(Part 2)/85				-	P	W		
				p) Void and Contamination test for insulation										-	P	W	
				q) Swell Height of water-swellaible tape										-	P	W	
				r) Lay Ratio of armour										-	P	W	
				s) Mass of Zinc coating for armour							IS 3975, IS 10810 Pt. 36 &			-	P	W	
				t) Uniformity of Zinc coating							IS 3975, IS 10810 Pt. 36			-	P	W	
				u) Printing over semicon										-	P	W	
				v) Water Penetration Test (WPT) on core (i.e. Longitudinal Water-Blocking Test)							IEC 60502-2	IEC 60502-2		-	P	W	
				w) Freely strippable insulation screen (Strippability Test)										-	P	W	
				x) Ovality check on core										-	P	W	
				y) Additional tests for FRLS cables													
				1) Tests on FRLS sheath													
				i) Oxygen Index test									-	P	W		
				ii) Temperature Index test									-	P	W		
				iii) Acid gas generation test									-	P	W		
				iv) Smoke density test									-	P	W		
				2) Flammability test on finished cable									-	P	W		
<b>D. PACKING &amp; MARKINGS</b>																	
1	<b>Packing &amp; Marking</b>	a)		Cable end sealing					100 %	IS 7098(Part 2)/85	IS 7098(Part 2)/85		-	P	V/W		
		b)		Pulling eye at leading end					100 %				-	P	V/W		
		c)		Stenciling / Marking on drum					100 %	IS 7098(Part 2):85	IS 7098(Part 2):85		-	P	V		

**Note :**

- Checks specified above for Raw Material, In-Process and Final Inspection shall be as relevant to the specific cable construction.
- Number of samples shall be selected as per Factory Standard/Agreement wherever 'sample' is indicated for extent of check.
- Plant standards shall be followed in case Technical Data Sheet does not include requirements for characteristics to be checked.
- R-Infra's may witness Raw materials and In process Inspections, in addition to Type/Routine/Acceptance tests, at any time/stage of manufacturing.
- R-Infra's Inspector shall randomly select a cable drum for type testing at vendor's premises / CPRI / ERDA among the lot offered for inspection.
- For each of the offered lot for inspection, R-Infra may randomly select one cable drum for testing of end cap "Destructive testing" to verify adhesion of sealing cap to cable outer sheath. Similarly, pulling eye shall be tested with 30N/mm<sup>2</sup> pressure.

**Annexure- G****Testing and manufacturing process requirements w. r. t. TR- XLPE insulation**

All cables made with TR-XLPE Insulation should be tested and/or certified to meet the following performance parameters as per ANSI /ICEA S-94-649 after one year AWTT.

Property	Units	Requirements Values
Min. Avg. Electrical Breakdown Strength(qual. test)	Kv/mm	$\geq 25$
Impulse Strength	Kv/mm	$\geq 83$
Water Tree Length	mm	0.25
Max. Bowtie Tree Density	(Number per 16.4 cu. cm)	Maximum 15 (0.12-0.25 mm range)

Manufacturing processes to produce high-quality cables with the following characteristics:

- Cure consistency with hot set/creep less than 100%
- No voids larger than 75 microns per 16.4 cubic cm
- No ambers larger than 250 microns per 16.4 cubic cm
- No contaminants larger than 125 microns and less than 5 between 50-125 microns per cubic 16.4 cubic cm tested.
- Neutral indent on cable is less than 375 microns
- Cable insulation concentricity greater than 90% tested
- No protrusions greater than 75 microns at the conductor shield and 125 microns at the insulation shield

Special Note on Type Test Required After Award of PO:

- i) Type test-1: Type test on one cable drum of each type/rating from any lot, shall be conducted at CPRI/ERDA on sample basis as per relevant IS/IEC. Sample shall be sealed by BRPL during inspection of cable. Cost for this type test shall be borne by the respective Bidder.
- ii) Type test -2: Type test on one cable drum of each type/rating from any lot shall be conducted at CPRI/ERDA on sample basis as per relevant IS/IEC. Sample shall be sealed by BRPL during inspection of cable. This type test is applicable subject to BRPL requirement and cost shall be borne by BRPL.

Special Note on OFC:

- i) OFC details:ITU-T G.657. A1 SINGLE MODE -36 NOS. OM-2 (50/125) MULTI MODE-12 NOS, 12 NOS OFC PER TUBE
- ii) 33kV, OFC embedded cable shall have 15 mm width red continuous marking by extrusion process on the outer sheath for identification purpose







**Technical Specification  
for  
H. T. Cables**

**(11kV : 1CX1000, 3CX300 and 3CX150 sqmm)**

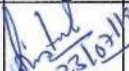
**Specification No: GN101-03-SP-172-00**

Prepared by		Reviewed by		Approved by		Rev./Pages	Date
Name	Sign	Name	Sign	Name	Sign		
Pronab Bairagi		Amit Tomar		K. Sheshadri		0/42	23.07.2019

**Index**

	Page
<b>General Specification</b> .....	4
<b>Annexures:</b>	
<b>Annexure A:</b> .....	18
<b>Scope, Documentation and Delivery Schedule</b>	
<b>Annexure B:</b> .....	20
<b>General Technical Particulars (GTP)</b>	
<b>Annexure C:</b> .....	27
<b>List of BRPL approved Sub-Vendors</b>	
<b>Annexure D :</b> .....	29
<b>Service Conditions</b>	
<b>Annexure E:</b> .....	30
<b>(Attachments)</b>	
a) <b>General Arrangement Drawing for Pulling-eye Assembly</b>	
b) <b>General Arrangement Drawing for End-sealing Cap</b>	
<b>Annexure F:</b> .....	33
<b>(Attachment)</b>	
<b>BRPL format (typical) for Quality Assurance Plan (QAP) for H. T. Cables</b>	
<b>Annexure G:</b> .....	42
<b>Testing and manufacturing process requirements w. r. t. TR- XLPE insulation</b>	
<b>Annexure H:</b> Deviation Format .....	42

## Revision Record

Sl. no.	Clause no.	Item descriptions	As per old Technical Specification(SP-EWHP-01-R3)	As per Revised Technical Specification(GN101-03-SP-172-00)	Date of approval	Approved by
1	2.0.0	Cable Construction Features	XLPE	TR-XLPE	23/07/19	KS
2	2.1.12-C-12	Embossing and printing	Drum no. was not included	Drum no. included in embossing along with laser printing at an interval 1 mtr.	23/07/19	KS
3	4.0.0-a	Type Test	Type test report with validity 5 years only	<p><u>Type Test Required After Award of PO:</u></p> <p>i) Type test-1: Type test on one cable drum of each type/rating from any lot, shall be conducted at CPRI/ERDA on sample basis as per relevant IS/IEC. Sample shall be sealed by BRPL during inspection of cable. Cost for this type test shall be borne by the respective Bidder.</p> <p>ii) Type test -2: Type test on one cable drum of each type/rating from any lot shall be conducted at CPRI/ERDA on sample basis as per relevant IS/IEC. Sample shall be sealed by BRPL during inspection of cable. This type test is applicable subject to BRPL requirement and cost shall be borne by BRPL.</p>	23/07/19	KS
4	4.0.0-c	Routine Test	1. CRM 2. HV 3. PD	<p><u>Test Added-</u></p> <p>1. Stripability 2. Impulse 3. Armour Coverage 4. Physical Dimensions</p>	23/07/19	KS
5	4.0.0-d	Inspection	Only Final Inspection was included	Added Stage Inspection before final inspection -OEM shall intimate 10 days advance to BRPL along with complete manufacturing scheduled	23/07/19	KS
6	4.0.0-e	Acceptance Tests	<p>a. Wafer Boil test- once per PO</p> <p>b. Void-and-contamination Test- once per PO</p> <p>c. Strippability Test- once per PO</p> <p>d. Water Penetration Test (WPT)- once per PO</p> <p>e. Impulse- not included</p> <p>f. Heating Cycle- not included</p>	<p><u>Upgraded</u></p> <p>a. Wafer Boil test- in each lot</p> <p>b. Void-and-contamination Test- in each lot</p> <p>c. Strippability Test- in each lot</p> <p>d. Water Penetration Test (WPT)- in each lot</p> <p><u>Added</u></p> <p>e. Impulse in each lot sample basis</p> <p>f. Heating Cycle with Potential on sample basis once per PO</p>	23/07/19	KS
7	6.0.0	Drum Length and Tolerance	<p><u>11kV, 3 Core cable</u></p> <p>a) 300 mtr +/- 5 %</p>	<p><u>11kV, 3 Core cable</u></p> <p>a) 300 mtr +/- 5 % (60% of PO qty.)</p> <p>b) 500 mtr +/- 5 % (40% of PO qty.)</p>	23/07/19	KS
8	7.0.0-e	Type of Drum	Steel/Wooden	only Steel non returnable	23/07/19	KS

Proposed by  
Pronab Bairagi



Reviewed by  
Amit Tomar



24/07/19

Approved by  
K. Sheshadri



## General Specification

### 1.0.0 Codes & Standards

The cables shall be designed, manufactured and tested in accordance with the following National Standards and IEC Standards.

#### National Standards

IS 7098 Part-2	Cross linked polyethylene (XLPE) insulated PVC sheathed cables for working voltages from 3.3 kV up to and including 33 kV.
IS 5831 : 1984	PVC insulation & sheath of electric cables.
IS 10810 : 1984	Methods of test for cables.
IS 8130 : 1984	Conductors for insulated electric cables and flexible cords.
IS 3975 : 1999	Mild steel wires, formed wires and tapes for armouring of cables.
IS 0462 (Part 1) / 1983	Fictitious Calculation Method for determination of dimensions of protective covering of cables

#### International Standards

IEC 60183	Guide to the selection of high voltage cables
IEC 60228	Conductors of insulated cables. Guide to the dimensional limits of circular conductors.
IEC 60332 – 3	Tests on electric cables under fire conditions. Part 3: Tests on bunched wires or cables.
IEC 60502 – 2	Power cables for rated voltages from 6 kV ( $U_m = 7.2$ kV) up to 30 kV ( $U_m = 36$ kV)
IEC 60811 Pts 1 through 5	Common test methods for insulating and sheathing materials of electric cables.
IEC 885 Pts 1 through 3	Electric test methods for electric cables.
IEC 28	International Standard of Resistance for Copper
IEC 332	Test on Electric Cables under fire conditions

### 2.0.0 Cable Construction Features

This Specification generally covers following types / sizes of TR-XLPE H. T. Cables used in BRPL network in Delhi area, mostly under-ground (buried, with chances of flooding by water) or for laying on racks, in ducts, trenches, conduits, and so on.

Technical Specification for H. T. Cables (11kV: 1CX1000, 3CX300 and 3CX150 sqmm)

Note: (Ref.: Table stating Cable sizes given below.)

Cable Code:

As per IS, cable designations comprise of following codes / options, as applicable for this Specification:

(N.A. - Not applicable for Specification)

- (with Copper conductor) (N.A.)

A Aluminium conductor

-----  
 2X XLPE insulation  
 -----

W Steel round Wire armour (N.A.)

WW Double steel round Wire armour (N.A.)

Wa Non-magnetic round Wire armour

F Steel formed wire (strip) armour

FF Double steel formed wire (strip) armour (N.A.)

Fa Non-magnetic formed wire (strip) armour (N.A.)

- ("un-armoured" or without armour) (N.A.)  
 -----

Y PVC outer sheath

Sr. No.	Description	Conductor Material	Cable Code
1.	11 kV, 3c x 150 sq. mm.	Al	A 2X F Y
2.	11 kV, 3c x 300 sq. mm.	Al	A 2X F Y
3.	11 kV, 1c x 1000 sq. mm.	Al	A 2X Wa Y

Description of each item mentioned in the Specification (the text, BOQ, GTP or any site specific requirement) shall be followed, along with IS: 7098 – Part 2.

2.1.1	<b>Conductor</b>	<ul style="list-style-type: none"> <li>a) Electrolytic Grade Stranded Aluminium Conductor</li> <li>b) Grade: H2 as per IS: 8130 / 1984 (For Al)</li> <li>c) Stranded, compacted and circular in shape</li> <li>d) Class 2</li> <li>e) “Longitudinal Water-Blocking Arrangement” (or water-tight construction or water barrier protection) shall be provided within the Conductor.               <ul style="list-style-type: none"> <li>i) As per manufacturer’s procedures, 100 % water-tight conductor shall be achieved.</li> <li>iii) Make &amp; Type of materials to be used (i.e. Water-swellaable tapes / yarn / powder, etc.) shall also be stated in the List of Sub-Vendors for pre-order approval.</li> </ul> </li> <li>f) All detailed constructional features shall be shown in the cross-sectional drawing.</li> </ul>
2.1.2	<b>Conductor Screen</b>	<p>Extruded semi-conducting material. (Also refer Cl. 2.1.3.) (Tapes are not acceptable)</p>
2.1.3	<b>Insulation</b>	<ul style="list-style-type: none"> <li>a) Extruded XLPE (Cross-Linked Poly-Ethylene) Insulation, with water-tree retardant (WTR) property</li> <li>b) The required compound used shall be from BRPL-approved sub-vendors and not from any other (refer Annexure – C).</li> <li>c) Uniform thickness of insulation shall be within the permissible values as per IEC Standards; eccentricity check shall be carried out to ensure this.</li> <li>d) Insulation Color : natural</li> </ul>

2.1.4	<b>Insulation Screen</b>	<p>a) Freely-strippable semi-conducting screen, which should not require application of heat for its removal. (Refer Cl. 2.1.3.)</p> <p>b) Text “Do not Heat - Freely Strippable” to be printed on insulation screen (at every 600 mm interval).</p> <p>c) Round shape over the outer semi-con shall be within the permissible limits as per IEC standards; Ovality check shall be carried out to ensure this.</p> <p>d) Compound used shall be suitable for the operating temperature of the Cable and shall be compatible with the insulation used.</p>
2.1.4A	<b>XLPE Process</b>	
2.1.4A-1	11 kV	Dry Cure and Dry Cool process only.
2.1.4A-2	Not in use	
2.1.4A-3	Extrusion	It is desirable that Conductor Screen, Insulation and Insulation Screen shall be extruded simultaneously, in a Single One-Time Process (i.e. as a triple-head extrusion) to ensure homogeneity of layers over the conductor, and absence of voids.
2.1.4A-4	Make of Compounds for Insulation and Semi-conducting	Any deviation from Approved Makes mentioned in Annexure-C shall not be acceptable, unless the deviation has been specifically approved by BRPL during tendering stage,
2.1.5	<b>Water-Swell able Tape</b>	<p>a) Semi-Conducting Water-Sellable Tape shall be provided, under the copper tape, on each core.</p> <p>b) Nominal thickness : 0.3 mm</p> <p>c) Weight: 118 gm / sq. m approx.</p> <p>d) Swell height: <math>\geq</math> 12 mm in 1 min.</p> <p>e) Compatible to strippable / non-strippable semi-</p>

		con, over which it is applied.
2.1.6	<b>Core Identification</b>	<p>a) For 3-core cables, cores shall be identified by coloured strips (Red, Yellow, Blue), applied helically / longitudinally below the copper tape.</p> <p>The coloured strips shall carry the name of cable manufacturer permanently printed at 1 meter intervals; this is to provide additional identification of manufacturer of the cable.</p>
2.1.6A	<b>Copper Tape</b>	Copper Tape shall be applied helically over the layer formed after application of insulation screen, water-swell able tape and identification strip.
2.1.7	<b>Filler</b>	<p>a) All interstices, including center interstices shall be filled by PP filler.</p> <p>b) PP Filler shall be non-hygroscopic, not having any effect on other compounds used, stable at cable temperatures, etc.</p> <p>c) PVC filler is not acceptable.</p> <p>d) Filler is not applicable for single-core cables.</p>
2.1.8	<b>Binder Tape</b>	As per manufacturer's standard
2.1.9	<b>Inner Sheath</b>	Extruded Inner Sheath of Black PVC type ST-2 (IS 5831)
2.1.10	<b>Armour</b>	<p>a) For 3-core Cables : Galvanised Steel flat strip armour</p> <p>b) For 1-core Cables : Non-magnetic round wire armour (hard-drawn aluminium wire)</p> <p>c) Minimum area of coverage of armouring shall be 90 % (min.). At any time, the gap between any two adjacent armour strips / wires shall not be</p>



		<p>more than the width of strip / diameter of wire.</p> <p>d) Zero negative tolerance is for :</p> <ul style="list-style-type: none"> <li>• Thickness of armour strip</li> <li>• Diameter of armour wire</li> </ul>
2.1.11	<b>Binder Tape</b>	Rubberised cotton tape
2.1.12	<b>Outer Sheath</b>	<p>a) Extruded outer sheath of PVC (ST-2 as per IS 5831) with termite-repellant and anti-rodent properties. (Outer Sheath shall be FRLS-type, if chosen by purchaser.)</p> <p>b) Shape of the cable over the outer sheath shall be circular, when manufactured / completed. Regular Ovality check shall be carried out at factory, to detect any abnormality. Manufacturing quality shall be such that cable will retain its circular shape, even after it is laid at site.</p> <p>c) The Outer Sheath shall be embossed as well as laser printed with following minimum text at a interval of 1 mtr:</p> <ol style="list-style-type: none"> <li>1. The voltage designation</li> <li>2. Type of construction / cable code (e.g. A2XFY)</li> <li>3. Manufacturer's Name and Trade-mark</li> <li>4. Number of cores and nominal cross-sectional area of conductor</li> <li>5. Progressive (sequential) length of cable at every meter, starting from zero for every drum. Colour filled in for the progressive marking, shall be with proper contrast in colouring.</li> <li>6. Name of buyer / purchaser,</li> <li>7. Month &amp; Year of manufacturing</li> </ol>

		<p>8. IS reference, i.e. IS : 7098</p> <p>9. Batch No. / Lot No. (For traceability purpose, in case of any, in case of any manufacturing defect or otherwise arising in the cable in future.)</p> <p>10. Purchase Order Number &amp; date</p> <p>11. Word ' FRLSH ', in case the cable is of FRLSH type.</p> <p>12. Drum no.</p>
2.1.13	<p><b>Pulling-eye Assembly and Sealing-end Cap</b> (for Cables)</p>	<p>a) A cable pulling-eye assembly Drg. No. MISC/E/4-1131/1698 (see Annexure-E) shall be provided at the loose end (outer end) of the cable on each drum. Sealing material shall be filled in inside the spaces / gaps between the pulling-eye assembly and cable outer sheath. Further, a heat-shrinkable sleeve shall be provided over the pulling-eye assembly and outer sheath of cable.</p> <p>b) Other end (inner end) of the cable shall be sealed as per MISC/E/4-1131/1699 (see Annexure-E.) One PVC cap with Polyurethane compound shall be provided as primary sealing and heat-shrink end-cap shall form a secondary sealing over the PVC cap.</p>
3.0.0	(This number not used.)	
4.0.0	<b>Testing &amp; Inspection</b>	Tests shall be carried out in accordance with IS 7098 (Part-2).
	a) Type Tests (IS 7098, IEC)	<p><u>1) To Qualify in Tender:</u> Cables must be of type tested quality. Type Test Reports shall be submitted for the type, size and rating of cable offered in the bid. Test report shall not be more than 5 years old.</p>

		<p>2) <u>Type Test Required After Award of PO:</u></p> <p>i) Type test-1: Type test on one cable drum of each type/rating from any lot, shall be conducted at CPRI/ERDA on sample basis as per relevant IS/IEC. Sample shall be sealed by BRPL during inspection of cable. Cost for this type test shall be borne by the respective Bidder.</p> <p>ii) Type test -2: Type test on one cable drum of each type/rating from any lot shall be conducted at CPRI/ERDA on sample basis as per relevant IS/IEC. Sample shall be sealed by BRPL during inspection of cable. This type test is applicable subject to BRPL requirement and cost shall be borne by BRPL.</p>
	b) BRPL QAP (Typical)	In general, all tests mentioned in the BRPL QAP (Characteristics – Typical) mentioned in Annexure-F shall be included in the Routine Tests, Type Tests and Acceptance Tests stated above.
	c) Routine Tests	<ol style="list-style-type: none"> <li>1. Measurement of Electrical Resistance</li> <li>2. HV Test with power frequency AC voltage</li> <li>3. Partial Discharge test</li> <li>4. “Strippability Test” at both the ends of cable for each drum, to check the freely-strippable property of the Insulation Screen (outer semi-con).</li> <li>5. Impulse voltage test of one drum</li> <li>6. Armour coverage measurement</li> <li>7. Physical test-Dimensions of each and every layer and components.</li> </ol> <p>Test results from the above tests must appear in the documents forwarded by the vendor for Inspection call / waiver.</p>
	d) Inspection	<ol style="list-style-type: none"> <li>1. The Buyer reserves the right to witness all tests specified on completed cables.</li> <li>2. The Buyer reserves the right to inspect cables at</li> </ol>

		<p>Sellers works at any time prior to dispatch, to verify compliance with the specifications.</p> <ol style="list-style-type: none"> <li>3. In-process (stage inspection) and final inspection call intimation shall be given at 10 days advance to the purchaser along with complete manufacturing scheduled.</li> <li>4. Minimum lot size of Cables to be offered for inspection shall be mutually agreed between Purchaser and Vendor, before placing the order. Vendor shall raise inspection call only after a minimum lot size is ready and with due factory routine tests already carried out.</li> </ol>
	<p>e) Acceptance Tests</p>	<p>Acceptance Tests shall be conducted as per Cl. 18.2 of IS 7098 (Part-2) and the approved Quality Assurance Plan (QAP) for each lot of cables.</p> <p>Following tests shall also be carried out during the Acceptance Tests :</p> <ol style="list-style-type: none"> <li>a) "Wafer Boil Test" for checking integrity of semi-conducting layers-in each lot.</li> <li>b) "Void-and-contamination Test" for the Insulation-in each lot</li> <li>c) "Strippability Test" at both the ends of cable for each drum, to check freely-strippable property of the Insulation Screen (outer semi-con) - in each lot.</li> <li>d) "Water Penetration Test (WPT)", as per applicable IEC standards, to check adequacy of water-blocking arrangement provided inside the conductor -in each lot.</li> <li>e) Impulse voltage test – in each lot sample basis.</li> <li>f) Heating Cycle along with potential once per PO on sample basis.</li> </ol>
	<p>f) Test Certificates (TC)</p>	<p>Three sets of complete Test Certificates (Routine tests and Acceptance tests) shall be submitted along with the delivery of cables.</p>

		<p>Soft copy of the TCs shall be separately e-mailed to the Purchaser.</p> <p><b>Note :</b></p> <p>Make/grades of critical materials (such as, for conductor screen, insulation, insulation screen, etc.), actually used during manufacturing of cables for order-on-hand, shall be clearly stated in the TCs forwarded by the Manufacturer, enabling references in future.</p>
5.0.0	<b>Drawing, Data and Manuals</b>	<p>a) Refer Annexure-A regarding Document Submission.</p> <p>b) Cross-Sectional Drawing shall show every feature of construction, including the thickness / diameter over every layer. This drawing shall also state the text to be embossed over the outer sheath - i.e. type/size, etc. of the cable, drum no./lot no., sequential marking over every meter, printing text on outer semi-con (“Do Not Heat-Freely Strippable”), font sizes to be used, additional text, if any, etc. Also, drum details, markings to be made on both sides of the drum, and so on.</p>
5.0.1	Documents to be submitted along with bid	<p>The vendor shall submit :</p> <p>a) Cross-sectional drawing</p> <p>b) GTP (all data to appear)</p> <p>c) Type Test certificates</p> <p>d) Dimensional drawing for pulling eye</p> <p>e) Fault Level Calculation for armour and copper tape screen</p> <p>f) Complete Cable Catalogue and Manual</p> <p>g) Armour Coverage Calculation</p> <p>h) Raw materials make list</p>

5.0.2	Documents after award of contract	Within 15 days, the seller has to submit four sets of above-mentioned drawings, along with one soft copy for buyer's approval.
5.0.3	Final As-Built Drawings	One soft copy of all documents, including type & routine test certificates.
6.0.0	<b>Drum length &amp; tolerance</b>	Cable length per drum
6.0.1	a) 11 kV, Three core  b) 11 kV, Single core	a) 300 mtr +/- 5 % (60% of the order quantity) and 500 mtr +/- 5% (40% of the ordered quantity)  a) 500 mtr +/- 5 %
6.0.2	Overall tolerance	+/- 2 % for the total cable length for the entire order.
6.0.3	Short length of cables	Manufacturer shall take prior approval from Purchaser for any supply of short length cables.  For 11 kV cables, minimum acceptable short length cables can be 250 meter.  In any case, manufacturer shall not put two cable pieces of different short lengths in same cable drum. Only one short length drum shall be accepted and in last lot only.
7.0.0	<b>Packing, Shipping, Handling &amp; Storage</b>	
	a) Packing	1. Both the ends of the cables shall be properly sealed to prevent any deterioration of the cable, due to ingress of water, etc. 2. Cable inner end (starting end) shall project, outside the completely wound cable, by sufficient length enabling verify cable details,

		<p>including the initial length marking.</p> <ol style="list-style-type: none"> <li>3. Similarly, outer end of the cable shall be saddled / secured to the drum properly to prevent any external damage to the end at any time.</li> <li>4. Before putting on wooden planks, protective covers (thick plastic sheets, etc.) shall be secured over the wound cable, to avoid any abrasion by wooden planks, over the outer sheath of the cable.</li> <li>5. After providing the protective covers, the cable drums shall be finally closed by wooden planks (with saddles), without leaving any gaps between the planks; i.e. 100 % covering shall be ensured.</li> </ol>
	<p>b) Drum Identification Markings:</p>	<p>Direct marking (i.e. text painting through stencils, etc.) shall be done on the drums, instead of attaching labels, which may be misplaced/lost over a period of time.</p> <ol style="list-style-type: none"> <li>1. Drum identification number</li> <li>2. Cable voltage grade</li> <li>3. Cable code (e.g. A2XFY, etc.)</li> <li>4. Number of cores and cross sectional area</li> <li>5. Cable quantity, i.e. cable length (meter)</li> <li>6. Purchase order number &amp; date</li> <li>7. SAP item code</li> <li>8. Total weight of cable and drum (kg)</li> <li>9. Manufacturer's Name</li> <li>10. Buyer's name</li> <li>11. Month &amp; Year of Manufacturing</li> <li>12. Direction of rotation of drum</li> <li>13. Cable length final end-markings (i.e., reading at the inner end and reading at the outer end, just before packing, shall be marked on the drum.)</li> </ol>
	<p>c) Shipping information</p>	<p>The seller shall give complete shipping information</p>

		concerning the weight, size of each package
	d) Transit damage	The seller shall be responsible for any transit damage due to improper packing.
	e) Type of Drum	Steel drums (all the drums shall be non returnable except otherwise mentioned in the tender), as per relevant IS / IEC.
	f) Cable Drum handling	The drums shall be with M.S. spindle plate (with nut-bolts) of adequate size to suit the spindle rods, normally required for handling the drums, according to expected weight of the cable drums.
8.0.0	<b>Quality Assurance Plan (QAP)</b>	
8.0.1	Vendor's QAP	Manufacturer shall submit QAP in line with BRPLQAP (Annexure-F) for purchaser's approval before starting of manufacturing which is mandatory
8.0.2	Inspection Points	As per BRPL approved QAP and special BRPL requirement if any to cross check the product quality. Seller must have to meet the special requirement of BRPL during inspection.
9.0.0	<b>Progress Reporting</b>	
9.0.1	Outline Document	To be submitted for purchaser's approval for outline of programmes for production, stage-inspection, testing, final inspection, packing, dispatch and documentation.
9.0.2	Detailed Progress Report	To be submitted to Purchaser once a month containing : i) Progress on material procurement ii) Progress on fabrication (as applicable) iii) Progress on assembly (as applicable) iv) Progress on internal stage-inspection v) Reason for any delay in total programme vi) Details of test failures, if any, during manufacturing stages.



		vii) Progress on final box-up Constraints / Forward Path
10.0.0	<b>Deviation</b>	<p>a) Deviations from this specification shall be listed separately by bidder clause wise (format given in Annexure- H) along with optional offer and has to submit the list along with bid/quotation. BRPL will review the deviations and if BRPL is agreed with the deviation, seller has to take written confirmation from BRPL on deviation during tender evaluation.</p> <p>b) In the absence of any separate list of deviations from the bidders with bid as well as written confirmation from BRPL on deviations, it will be assumed by the Buyer that the Seller complies with the Specification fully.</p> <p>c) Any deviations mentioned in any other submitted bid documents (i.e.in filled GTP, Catalog, BRPL old approval, buyer's/seller's standards etc.) by seller without separate deviation sheets will not consider as a deviation from this tech spec at any stage of contract.</p>

**Annexure – A****Scope, Documentation and Delivery schedule****1. Scope**

A.	Scope	Design, manufacture, testing at manufacturer's works before dispatch, packing, delivery, unloading, stacking at stores/site of H.T. Power cables, as per Purchaser's BOQ (Bill of Quantity).
B.	Delivery Schedule	To be filled up on a case-to-case basis.

**a) Document Submission**

Submission of drawings, calculations, catalogues, manuals, test reports shall be as follows. (Also refer clause 5.0.0 – Drawings, Data and Manuals.)

Legend:

GTP : Guaranteed Technical Particulars  
TTR : Type Test Report  
RTR : Routine Test Report

	Documents Along with offer	After award of contract - for Approval	Final documents (after Approval)
<b>GTP</b>	3 copies	** 1 soft copy	** 1 soft copy + CD
<b>Drawings</b>	3 copies	** 1 soft copy	** 1 soft copy + CD
<b>Calculations</b>	3 copies	** 1 soft copy	** 1 soft copy + CD
<b>Catalogues &amp; Manual</b>	1 copy each		** 1 soft copy + CD
<b>Test Report</b>	1 copy each of TTR and sample RTR		** 1 soft copy + CD

\*\* Soft copy and CD shall contain documents duly approved, signed and scanned.

**3. Delivery Schedule**

- a) Delivery period Start Date : From date of LOI / LOA
- b) Delivery period End Date : As agreed with supplier
- c) Material dispatch Clearance : After inspection by purchaser

## Annexure - B

### GUARANTEED TECHNICAL PARTICULARS (GTP)

**Note:**

- 1) For every type / size of cable, every data shall be mentioned.
- 2) Seller may submit separate GTP for every type / size of cable, as suitable.
- 3) GTP requirements are generally as per IS: 7098 (Part-II).
- 4) GTP shall be read in line with purchaser's Project Site Specific Requirement.

Sr. No.	Description	Buyer's requirement	Unit	Seller's Data
1.0	Purchase Req. No.	-		
2.0	Guarantee Period (Min.)	60 Months (from date of commissioning) / 66 Months (from date of receipt at purchaser's store) whichever is earlier		
3.0	Applicable IS / IEC Standard followed by vendor	IS 7098 Part-2 / IEC 60502-2		
4.0	Make	-		
5.0	<b>Type</b> (as required by purchaser)			
	a) 11 kV, 3c x 150 sq. mm.	A2XFY		
	b) 11 kV, 3c x 300 sq. mm.	A2XFY		
	c) 11 kV, 1c x 1000 sq. mm.	A2XWaY		
6.0	<b>Voltage Grade</b>			
	a) 11 kV, 3c or 1c	6.35 / 11	kV	
7.0	Maximum Conductor temperature			
A	Continuous	90	deg. C	
B	Short time	250	deg. C	
8.0	<b>Conductor</b>	Compacted, Circular, Water tight construction is mandatory		
A	Material and Grade	As per Cl. 2.1.1		
B	Size	As shown under 5.0 above		
C	Wires in each conductor	As per Table 2 of IS 8130	Nos.	

## Technical Specification for H. T. Cables (11kV: 1CX1000, 3CX300 and 3CX150 sqmm)

D	Conductor Shape	As per Cl. 2.1.1 e		
E	Dia. of wires in each conductor before compaction	Manufacturer Standard	mm	
F	Diameter over conductor		mm	
G	Maximum Conductor resistance at 20 ° C			
	a) 11 kV, 3c x 150 sq. mm.	0.2060	ohm/km	
	b) 11 kV, 3c x 300 sq. mm.	0.1000	ohm/km	
	c) 11 kV, 1c x 1000 sq. mm.	0.0291	ohm/km	
H	Longitudinal Water Blocking Arrangement within conductor	Is it provided and shown in the cross-sectional drawing? (Yes / No)		
I	Short circuit current-carrying capacity of conductor		kA for 1 sec.	
9.0	<b>Conductor Screen</b> (inner semi-con)			
A	Material & type	As per Cl. 2.1.2		
B	Thickness (min)	0.50	mm	
C	Diameter over conductor screen		mm	
D	Make and grade of semi-conducting compound			
10.0	<b>Insulation</b>			
A	Insulation Material	As per Cl. 2.1.3		
B	Nominal thickness			
	a) 11 kV, 3c or 1c	3.6	mm	
C	Minimum thickness			
	a) 11 kV, 3c or 1c	3.14	mm	
D	Diameter over Insulation		mm	
E	Make and grade of Insulation compound			
F	Eccentricity	As per IEC standards	%	
G	Water-tree retardant property	Required		
11A.	<b>Insulation Screen</b> (outer semi-con)			
a.	i) Thickness of freely strippable Semi conducting screen	0.50	mm	
	ii) Make and grade of semi-conducting compound			
	iii) Printing	As per Cl. No. 2.1.4 (Yes / No)		
	iv) Ovality of the core	2	%	
b.	Diameter over Insulation Screen (approx.)		mm	
11B.	<b>Water-Swellable Tape</b>			

	(if required by Purchaser)			
	a) Thickness b) Weight c) Swell height d) Compatible to strippable / non-strippable semi-con, over which it is applied. e) Make & Grade f) Pre-slitted packed tapes from sub-vendors approved by BRPL	a) 0.3 mm b) 118 gm / sq. m c) $\geq 12$ mm in 1 min. d) Yes / No  e) Pl. state f) Yes / No		
11C.	<b>Cable Core identification</b>			
	a) By coloured strips over cores applied helically / longitudinally b) Manufacturer's name shall be permanently printed on the strips, at close intervals.			
11D.	<b>Copper Tape</b>			
	i) Dimensions	a) Thickness : 0.06 + 5 % b) Width : 50 mm  C) Overlap: 10% d) no negative tolerance in thickness of copper tape	Mm	
	ii) Fault current-carrying capacity of copper tape	Manufacturer's Standard (Calculation sheet shall be attached)	... kA for ... sec.	
11E.	Diameter over laid up core (approx.)		mm	
12.0	<b>Filler</b> (Material and type)	As per Cl. 2.1.7 (Specify no. & size of filler at center & core interstices)		
	a) 11 kV, 3c x 150 sq. mm.			
	b) 11 kV, 3c x 300 sq. mm.			
	d) 11 kV 1core	Not applicable		
12A.0	<b>Binder Tape</b>	over laid-up cores		
13.0	<b>Inner Sheath</b>			
A	Material and type	As per Cl. 2.1.9		

## Technical Specification for H. T. Cables (11kV: 1CX1000, 3CX300 and 3CX150 sqmm)

B	Minimum thickness			
	a) 11 kV, 3c x 150 sq. mm.	0.6	mm	
	b) 11 kV, 3c x 300 sq. mm.	0.7	mm	
	c) 11 kV, 1c x 1000 sq. mm.	0.7	mm	
C	Approx. dia. over inner sheath		mm	
14.0	<b>Armour</b>	as per purchaser's requirements		
A	Material			
	a) 11 kV, 3c	G. I. Strip	No.	
	b) 11 kV 1c	non-magnetic wire armour (Aluminium wire)	No.	
B	Armour – Wires	As per Table 4 of IS 7098 Part-2 (zero negative tolerance for diameter)		
	a) Diameter of wire		mm.	
	b) Number of wires (min.)		no.	
C	Armour – GI strips			
	a) Width of strip & Thickness of strip	4 x 0.8 (zero negative tolerance for thickness)	mm	
	b) Number of strips (min.)		no.	
D	Approx. Equivalent Area		sq. mm.	
E	Area covered by armour	Min. 90 % Calculation shall be attached.	%	
F	Dia. over armour - approx.		Mm	
G	Fault current carrying capacity of armour	Calculation sheet shall be attached.	... kA for ... sec.	
15.0	<b>Outer Sheath</b>			
A	Material and type	As per Cl. 2.2.12		
B	Thickness (min.)	** As per Table-5 of IS 7098 Part-2		
	a) 11 kV, 3c x 150 sq. mm.	**	mm	
	b) 11 kV, 3c x 300 sq. mm.	**	mm	
	e) 11 kV, 1c x 1000 sq. mm.	**	mm	
C	Color	Blue		
D	Embossing (details as per Cl. 2.1.12)	Yes		
E	FRLS Properties	As per customer's requirement		
16.0	Approx. overall diameter		mm	

17.0	Standard drum length with tolerance			
	a) 11 kV, 3c x 150 / 300 sq. mm.	300 +/- 5% (60% of PO qty.) 500 +/- 5% (40% of PO qty.)	meters	
	b) 11 kV 1c x 1000 sq. mm.	500 +/- 5%	meters	
17A	Overall order tolerance	+ / - 2 % for the total cable length for the entire order.		
18.0	<b>Cable Drum</b>			
	a. Type of drum	Steel non returnable (Specify the relevant IS / IEC followed for drum design)		
	b. Markings on the drum (as per Cl. 7.0.0)	On both faces		
18A.0	<b>Cross-Sectional Drawing</b> (ref. Cl. 5.0.0)	Is drawing submitted, showing every feature of constructions? (Yes / No)		
19.0	<b>a. Pulling-eye Assembly</b> (provided at one running end) Refer drawing in Annexure-E	Is manufacturer's / Sub-vendor's drawing submitted? (Yes / No)		
	<b>b. Sealing-end Cap</b> (provided at the other end) Refer drawing in Annexure-E	Is manufacturer's / Sub-Vendor's drawing submitted? (Yes / No)		
20.0	<b>Weights</b>			
	a) Net weight of cable (approx.)		kg / km	
	b) Weight of empty drum		Kg	
	c) Weight of Cable with drum		kg	
21.0	Continuous current rating for standard I. S. condition laid Direct			
	a) In ground 30° C		Amp	
	b) In duct 30° C		Amp	
	c) In air 40° C		Amp	
22.0	(not used)			



23.0	Electrical Parameters at Maximum Operating temperature:			
A	AC Resistance		ohm / km	
B	Reactance at 50 c/s		ohm / km	
C	Impedance		ohm / km	
D	Zero sequence impedance		ohm / km	
E	Positive sequence impedance		ohm / km	
F	Negative sequence impedance		ohm / km	
G	Capacitance		micro-farad / km	
24.0	Recommended minimum bending radius	12 x O. D.	mm	
25.0	De-rating factor for following Ambient Temperatures :	Ground / Air		
	a) At 30° C			
	b) At 35° C			
	c) At 40° C			
	d) At 45° C			
	e) At 50° C			
26.0	Group factor for following numbers of cables laid :	Touching Trefoil		
	a) 3 Nos.			
	b) 4 Nos.			
	c) 5 Nos.			
	d) 6 Nos.			
27.0	Recommended pressure for laying cable using power winch	30 N / mm <sup>2</sup>	N / sq. mm.	
28.0	Process of Cross-linking of Polyethylene			
	a) 11 kV, 3c or 1c	Dry Cure process and Dry Cooling only		
29.0	<b>Type test</b> (TTR - Type Test Report)	Is copy of latest valid TTR for respective sizes enclosed? (Yes / No)		

30.0	<b>Quality Assurance Plan (QAP)</b>	Is QAP Format (Annexure-F), duly filled in and enclosed? (Yes / No)		
31.0	<b>List of Sub-Vendors for construction items (Annexure-C)</b>	Is this list enclosed for BRPL approval? (Yes / No)		

**Annexure - C****List of Sub-Vendors for critical items**

Vendor/Bidder to state sub-vendors' names for other items, wherever approved names are not mentioned, for purchaser's approval during tendering stage else purchaser shall impose as per their requirement and bidder to follow the same in post-order stages.

Ser. No.	Raw Materials		Name of the Make
1.	XLPE Compound	1	Dow Chemicals , U.S.A.
		2	Borealis , Sweden
		3	Hanwha , South Korea
2.	Semi-Conducting Compound	1	Dow Chemicals, U.S.A.
		2	Borealis , Sweden
		3	Hanwha , South Korea
3.	Conductor Water-Blocking tapes / yarn	1	Lantor
		2	Geca
		3	Miracle
		4	Scapa
		5	Sneham International
4.	Water-Swellable Tapes (Pre-slitted)	1	Lantor
		2	Geca
		3	Miracle
		4	Scapa
		5	Sneham International
5.	Aluminium Rod	1	Bharat Aluminium Co. Ltd. (BALCO)
		2	Hindustan Aluminium Co. Ltd. (HINDALCO)
		3	National Aluminium Co. Ltd. (NALCO)

Ser. No.	Raw Materials		Name of the Make
		4	Vedanta (Sesa Sterlite)
6.	Copper Tape	1	Aggarwal Metal
		2	Indian Smelting
		3	Luvata Swedan
		4	Outokumpu Copper Strip AB, Swedan
7	Galvanised Steel Wires / Strips	1	Tata
		2	Balaji
		3	Systematic
		4	Mica Wires Pvt. Ltd.
		5	Bansal Industries
8	PVC Compound	1	Kalpana
		2	Universal
		3	SCJ Plastic
		4	Sriram Polytech
		5	Shri Ram Vinyl, Kota
9	P. P. Fillers	1	Vijoy Polymers
		2	Yash Polymers
		3	AVSL Industries
10	Core Identification Tape	1	AVSL Industries
		2	Yash Polymer
		3	Vijoy Polymers
11	PE Compound	1	Borealis
		3	Shakun
		4	Kalpana

**Annexure - D****Service Conditions**

(Atmospheric / Soil conditions at Site)

<b>B. Delhi</b>		
a)	Average grade atmospheric condition	Heavily polluted, dry
b)	Maximum altitude above sea level	1000 M
c)	Air temperature Ambient	i) Highest : 50 deg C ii) Average : 40 deg C iii) Minimum : 0 deg C
d)	Relative Humidity	100 % max
e)	Thermal Resistivity of Soil	150 deg. C. cm / W max.
f)	Seismic Zone	4
g)	Rainfall	750 mm concentrated in four months

**Annexure E**

1. General Arrangement Drawing for Cable Pulling Eye
  
2. General Arrangement Drawing for End-sealing Cap

Both the above drawings are given on next pages.



### DIMENSIONS

SIZE	A	A	B	C	D	LC %	T
	EXP. (Min.)	REC. (Max)	EXP. (Min.)	EXP. (Min.)	EXP. (Min.)	(WALL REC. ± 20 %)	
EC 120/150	75	34	120	105	50	± 10	4.2
EC 240/300	100	62	130	110	70	± 10	3.5
EC 400	145	75	155	120	70	± 10	4.6

EXP - Expanded (as supplied), REC - Recovered freely, LC - Longitudinal Change, T - Wall Thickness, EC - End Cap

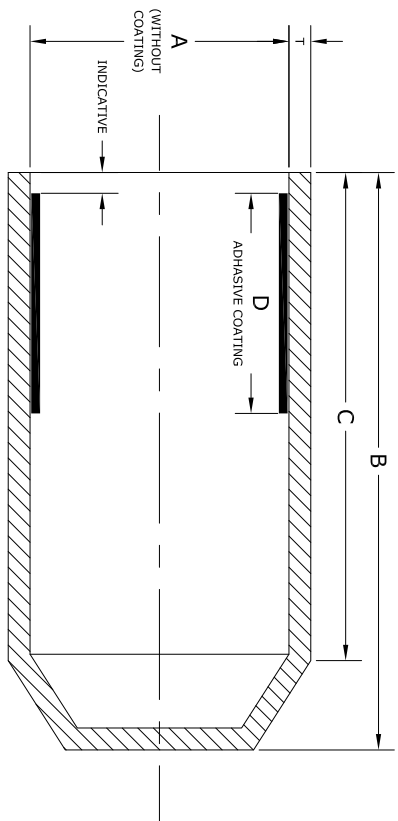

**END CAP**  
(AS SUPPLIED)  
SECTIONAL VIEW

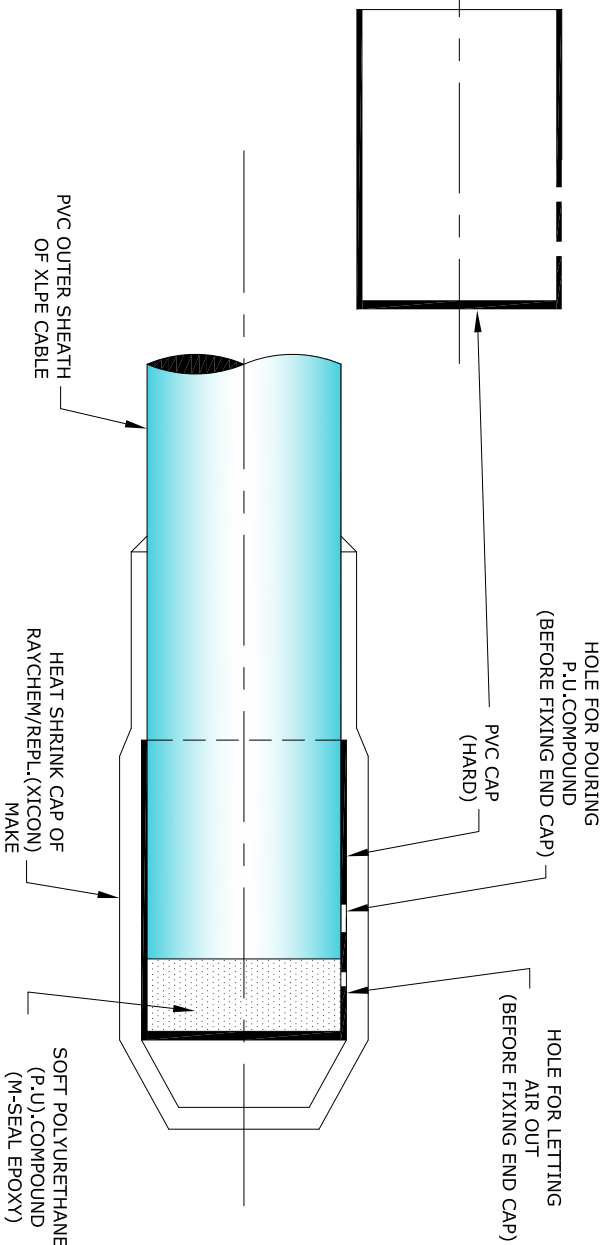

**END CAP**  
(AFTER HEAT SHRINKING OVER THE CABLE END)

### MATERIAL SPECIFICATIONS

Characteristics	Test Class	Value	Test Method
<b>Physical Properties</b>			
1 Specific Gravity	Type	1.05 ± 0.2	ASTM D -1505
2 Water Absorption	Type	1 % (max)	ASTM D-570 / ISO 62
3 Tensile Strength	Routine	10 N/sqmm (min)	ASTM D-412 / ISO 37
4 Ultimate Elongation	Routine	300% (min)	ASTM D-412 / ISO 37
5 Hardness	Type	45 shore D ± 3	ASTM D -2240
<b>Thermal Test</b>			
6 Thermal Ageing (120°C for 500 hrs)			
1 Tensile Strength	Type	8 N/sqmm (min)	ASTM D-412 / ISO 37
2 Ultimate Elongation	Type	200% (min)	ASTM D-412 / ISO 37
<b>Electrical Properties</b>			
1 Volume Resistivity	Type	10 <sup>14</sup> ohm-cm. (min)	ASTM D-257 / IEC 93
2 Dielectrical Strength	Type	10 kV/mm. (min)	ASTM D149 / IEC 243
3 Dielectric Constant	Type	5 (max)	ASTM D1507 / IEC 250

Note : 1) All dimension in mm  
2) Colour Black  
3) Size as mentioned in the table shall be stencilled on respective item

**BSES**

DRAWING No. MISC/E/4-1131/1698

SCALE :NOT TO SCALE DATE: 09-05-2011

**END SEALING CAP**  
(FOR XLPE CABLE)

DRAWN BY: BUR CHECKED BY: AP/DS/PS APPROVED BY:  
REVISIONS

Adtl. V.P.



**Annexure- F****QAP Format  
(Quality Assurance Plan)  
For H. T. Cables (Typical)**

Typical Characteristics are mentioned in the above QAP format, which is appearing on the next pages.

Vendor shall submit the QAP, duly filled in, in accordance with IS / IEC standards and manufacturer's standards/procedures, for Purchaser's approval, during pre-order / post-order stages.



**QUALITY ASSURANCE PLAN (QAP)  
FOR 11 kV H. T. CABLES**

S. NO.	COMPONENT & OPERATION	CHARACTERISTICS	CLASS	TYPE OF CHECK	QUANTUM OF CHECK	REFERENCE DOCUMENT	ACCEPTANCE NORMS	FORMAT OF RECORD	AGENCY			Remark
									SV	MFR	BRPL	
1	2	3	4	5	6	7	8	9	10	11	12	13
Legend : SV : Sub-Vendor of Cable Manufacturer, MFR : Cable Manufacturer, MPS : Material Purchase Specification,												
BRPL : BSES Rajdhani Power Ltd, P : Perform, W : Witness, V : Verification												
<b>A RAW MATERIAL</b>												
1	Aluminium/Copper Rod	a) Tensile strength	Major	Physical	Sample	MPS	MPS	Reg./Sheet	P	P/V	V	
		b) Resistivity	Major	Electrical	Sample	MPS	MPS	Reg./Sheet	P	P/V	V	
		c) Diameter	Major	Physical	Sample	MPS	MPS	Reg./Sheet	P	P/V	V	
		d) Chemical composition	Major	Chemical	Sample	MPS	MPS	Test certificate	P	V	V	
		e) Surface finish	Major	Visual	Sample			-	P	P	-	
2	PVC Compound	a) Tensile Strength	Major	Physical	Sample	MPS	MPS	Reg./Sheet	P	P/V	V	
		b) Elongation at break	Major	Physical	Sample	MPS	MPS	Reg./Sheet	P	P/V	V	
		c) Thermal stability	Major	Physical	Sample	MPS	MPS	Reg./Sheet	P	P/V	V	
3	TR-XLPE Compound (Borealis/Dow chemical/ Hanwa)	a) Packing	Minor	Visual	100%	MPS	MPS	-	P	V	-	
		b) Tensile Strength	Major	Physical	Sample	MPS	MPS	Reg./Sheet	P	P/V	V	
		c) Elongation at break	Major	Physical	Sample	MPS	MPS	Reg./Sheet	P	P/V	V	
		d) Hot set test	Major	Physical	Sample	MPS	MPS	Reg./Sheet	P	P/V	V	
		e) Volume Resistivity	Major	Electrical	Sample	MPS	MPS	Reg./Sheet	P	P/V	V	
		f) Cure Curve (Max. Torque)	Major	Physical	Sample	MPS	MPS	Reg./Sheet	-	P	V	
		g) Density	Major	Physical	Sample	MPS	MPS	Reg./Sheet	P	P/V	V	
4	Semi-conducting Compound (Borealis/Dow chemical/ Hanwa)	a) Packing	Minor	Visual	100%	MPS	MPS	-	P	V	-	
		b) Volume Resistivity	Major	Electrical	Sample	MPS	MPS	Reg./Sheet	P	P/V	V	
		c) Tensile Strength	Major	Physical	Sample	MPS	MPS	Reg./Sheet	P	P/V	V	
		d) Elongation at break	Major	Physical	Sample	MPS	MPS	Reg./Sheet	P	P/V	V	
		e) Cure Curve (Max. Torque)	Major	Physical	Sample	MPS	MPS	Reg./Sheet	-	P	V	
		f) Density	Major	Physical	Sample	MPS	MPS	Reg./Sheet	P	P/V	V	
5	Copper tape	a) Thickness & width	Major	Physical	Sample	MPS	MPS	Reg./Sheet	P	P/V	V	
		b) Tensile Strength	Major	Physical	Sample	MPS	MPS	Reg./Sheet	P	P/V	V	
		c) Elongation at break	Major	Physical	Sample	MPS	MPS	Reg./Sheet	P	P/V	V	
		d) Resistivity	Major	Electrical	Sample	MPS	MPS	Reg./Sheet	P	P/V	V	
6	Armour wires/strips (Galvanised steel)	a) Dimensions	Major	Physical	Sample	MPS	MPS	Reg./Sheet	P	P/V	V	
		b) Surface condition/finish	Major	Visual	Sample	MPS	MPS	Reg./Sheet	P	P/V	V	
		c) Tensile Strength	Major	Physical	Sample	MPS	MPS	Reg./Sheet	P	P/V	V	
		d) Elongation at break	Major	Physical	Sample	MPS	MPS	Reg./Sheet	P	P/V	V	
		e) Torsion test for round wire	Major	Physical	Sample	MPS	MPS	Reg./Sheet	P	P/V	V	
		f) Wrapping test	Major	Physical	Sample	MPS	MPS	Reg./Sheet	P	P/V	V	
		g) Mass of zinc coating	Major	Physical	Sample	MPS	MPS	Reg./Sheet	P	P/V	V	
		h) Uniformity of zinc coating	Major	Physical	Sample	MPS	MPS	Reg./Sheet	P	P/V	V	
		i) Adhesion test	Major	Physical	Sample	MPS	MPS	Reg./Sheet	P	P/V	V	
		j) Resistivity test	Major	Electrical	Sample	MPS	MPS	Reg./Sheet	P	P/V	V	
		7	Water Swellable	a) Dimensions	Minor	Physical	Sample	MPS	MPS	Reg./Sheet	P	P/V



**QUALITY ASSURANCE PLAN (QAP)  
FOR 11 kV H. T. CABLES**

S. NO.	COMPONENT & OPERATION	CHARACTERISTICS	CLASS	TYPE OF CHECK	QUANTUM OF CHECK	REFERENCE DOCUMENT	ACCEPTANCE NORMS	FORMAT OF RECORD	AGENCY			Remark
									SV	MFR	BRPL	
1	2	3	4	5	6	7	8	9	10	11	12	13
Legend : SV : Sub-Vendor of Cable Manufacturer, MFR : Cable Manufacturer, MPS : Material Purchase Specification, BRPL : BSES Rajdhani Power Ltd, P : Perform, W : Witness, V : Verification												
	tape	b) Swelling height	Major	Physical	Sample	MPS	MPS	Reg./Sheet	P	P/V	V	
		c) Resistivity	Major	Electrical	Sample	MPS	MPS	Reg./Sheet	P	P/V	V	
		d) Weight	Major	Physical	Sample	MPS	MPS	Reg./Sheet	P	P/V	V	
8	Steel Drum	a) Dimension	Major	Meas.	1 sample per size	IS 10418 / Purchase order		-	P	P	-	
		b) Finish & workman ship	Minor	Visual	1 sample per size	Compliance to standard Engineering norms & free from surface defects		-	P	P	-	
9	Cable Pulling eye	a) Dimensions & Material	Major	Meas.	1 sample per size	Purchase order	Purchase order	-	P	P	-	
		b) Finish & workman ship	Minor	Visual	1 sample per size	Compliance to standard Engineering norms & free from surface defects		-	P	P	-	
		c) Tension test on pulling eye	Major	Physical	1 sample per size	Pulling eye subjected to load		-	P	P	-	
10	Binder tape	a) Dimensions & material	Minor	Physical	Sample	MPS	MPS	-	P	P	-	
11	Polypropylene filler	a) Size	Minor	Physical	Sample	Purchase order	Purchase order	-	P	P	-	
12	Heat shrinkable end cap	a) Bore diameter	Major	Physical	1 sample per size	--	--	-	-	P	-	
		b) Length of end cap	Minor	Physical	1 sample per size	--	--	-	-	P	-	
<b>B PROCESS INSPECTION</b>												
1	Wire Drawing	a) Diameter	Major	Physical	Sample			Reg./Sheet	-	P	V	
		b) Surface finish	Major	Visual	100 %	Smooth & free from defects		--	-	P	-	
		c) Tensile test (for Al)	Major	Physical	Sample	IS: 8130/84	IS: 8130/84	Reg./Sheet	-	P	V	
		d) Elongation test (for Cu)	Major	Physical	Sample	IS: 8130/84	IS: 8130/84	Reg./Sheet	-	-	V	
		e) Wrapping test (for Al)	Major	Physical	Sample	IS: 8130/84	IS: 8130/84	Reg./Sheet	-	P	V	
2	Stranding	a) No. of wires/strands	Major	Physical	At the time of m/c setting			Reg./Sheet	-	P	V	
		b) Lay length & Lay direction	Major	Physical	-do-			-	-	P	V	
		c) Dia of conductor	Major	Physical	During setting & once in each shift			Reg./Sheet	-	P	V	
		d) Surface finish	Major	Visual	100 %	No surface defects and free from sharp edges, scratches, grease, oil etc.		-	-	P	-	
3	Core extrusion (Conductor screen, Insulation & insulation screen)	a) Compound Make/Grade	Major	Visual	During m/c setting			-	-	P	-	Insulation screen shall be freely strippable, without application of heat.
		b) Thickness of insulation & extruded S.C. layers	Major	Physical	During m/c setting after stabilisation	Tech. Data Sheet / IS 7098/II/2011	Tech. Data Sheet / IS 7098/II/2011	Reg./Sheet	-	P	V	
		c) Surface finish	Minor	Visual	100 %	Smooth & free from defects		-	-	P	-	



**QUALITY ASSURANCE PLAN (QAP)  
FOR 11 kV H. T. CABLES**

S. NO.	COMPONENT & OPERATION	CHARACTERISTICS	CLASS	TYPE OF CHECK	QUANTUM OF CHECK	REFERENCE DOCUMENT	ACCEPTANCE NORMS	FORMAT OF RECORD	AGENCY			Remark
									SV	MFR	BRPL	
1	2	3	4	5	6	7	8	9	10	11	12	13
Legend : SV : Sub-Vendor of Cable Manufacturer, MFR : Cable Manufacturer, MPS : Material Purchase Specification, BRPL : BSES Rajdhani Power Ltd, P : Perform, W : Witness, V : Verification												
		d) Printing on outer semi- conducting layer	Major	Visual	100 %	"DO NOT HEAT, FREELY STRIPPABLE"		-	-	P	-	
		e) Tensile Strength	Major	Physical	Sample	IS 7098/II/2011	IS 7098/II/2011	Reg./Sheet	-	P	V	
		f) Elongation at break	Major	Physical	Sample	IS 7098/II/2011	IS 7098/II/2011	Reg./Sheet	-	P	V	
		g) Hot set test	Major	Physical	Sample	IS 7098/II/2011	IS 7098/II/2011	Reg./Sheet	-	P	V	
		g1) Ovality of core	Minor	Physical	Sample	Tech. Data Sheet	Tech. Data Sheet	Reg./Sheet	-	P	V	
		h) Eccentricity of insulation	Minor	Physical	Sample	Tech. Data Sheet	Tech. Data Sheet	Reg./Sheet	-	P	V	
		i) Core diameter	Minor	Physical	Sample	Tech. Data Sheet	Tech. Data Sheet	Reg./Sheet	-	P	V	
		j) Void & contamination test for insulation (Silicon Oil test)	Major	Physical	Sample			-	-	P	V	
		k) Wafer boil test for extruded semi-conducting layers	Major	Physical	1 sample/lot	BIS draft Specn	BIS draft Specn	Reg./Sheet	-	P	V	
4	Taping - water Swellable semi-conducting	a) Dimensions	Minor	Physical	Sample	Tech. Data Sheet	Tech. Data Sheet	-	-	P	-	
		b) Tape Application (Overlap)	Minor	Visual	During m/c setting	Suitable overlap	Suitable overlap	-	-	P	-	
5	Taping - Copper tape	a) Width & Thickness of tape	Major	Physical	During m/c setting	Tech. Data Sheet	Tech. Data Sheet	Reg./Sheet	-	P	V	
		b) Number of tapes	Major	Visual	During m/c setting	Tech. Data Sheet	Tech. Data Sheet	Reg./Sheet	-	P	V	
		c) Tape application (Overlap)	Minor	Visual	During m/c setting	Tech. Data Sheet	Tech. Data Sheet	-	-	P	-	
6	Laying up	a) Identification of cores	Major	Visual	During m/c setting	Tech. Data Sheet	Tech. Data Sheet	-	-	P	-	Cores shall be laidup with PP fillers & suitable tape binder shall be provided over laid up assembly
		b) Direction of lay, core Sequence & Lay length	Major	Visual	During m/c setting	IS 7098/II/2011, PIL-W-02	IS 7098/II/2011, PIL-W-02	-	-	P	-	
		c) Application of binder tape	Minor	Visual	During m/c setting	Tech. Data Sheet		-	-	P	-	
		d) Shape of laid up assembly	Minor	Visual	100%	Reasonably circular	Reasonably circular	-	-	P	-	
7	Inner sheath	a) Material & type	Major	Visual	During m/c setting	Tech. Data Sheet	Tech. Data Sheet	-	-	P	-	
		b) Thickness	Major	Physical	During m/c setting & drum change	Tech. Data Sheet & IS 7098/II/2011	ech. Data Sheet & IS 7098/II/2011	Reg./Sheet	-	P	V	
		c) Surface finish	Minor	Visual	100 %	Surface shall be smooth & free from defects		-	-	P	-	
		d) Colour of inner sheath	Major	Visual	100 %	Tech. Data Sheet	Tech. Data Sheet	-	-	P	-	
8	Armouring	a) Dimension of armour wires/strips	Major	Physical	During m/c setting	Tech. Data Sheet	Tech. Data Sheet	Reg./Sheet	-	P	V	No negative tol. on strip thickness/wire diameter
		b) No. of armour strip/wire	Major	Counting	During m/c setting	Tech. Data Sheet	Tech. Data Sheet	Reg./Sheet	-	P	V	



**QUALITY ASSURANCE PLAN (QAP)  
FOR 11 kV H. T. CABLES**

S. NO.	COMPONENT & OPERATION	CHARACTERISTICS	CLASS	TYPE OF CHECK	QUANTUM OF CHECK	REFERENCE DOCUMENT	ACCEPTANCE NORMS	FORMAT OF RECORD	AGENCY			Remark	
									SV	MFR	BRPL		
1	2	3	4	5	6	7	8	9	10	11	12	13	
<b>Legend : SV : Sub-Vendor of Cable Manufacturer, MFR : Cable Manufacturer, MPS : Material Purchase Specification, BRPL : BSES Rajdhani Power Ltd, P : Perform, W : Witness, V : Verification</b>													
		c) Armour coverage	Minor	Visual	During m/c setting	IS 7098/II/2011	IS 7098/II/2011	-	-	P	-		
		d) Direction of lay	Major	Visual	During m/c setting	IS 7098/II/2011	IS 7098/II/2011	-	-	P	-		
		e) Lay length/Gear setting	Minor	Visual	During m/c setting			-	-	P	-		
		f) Surface finish	Major	Visual	100 %	No cross over/over riding of wire/strip		-	-	P			
9	Outer sheath/Rewinding	a) Material & type	Major	Visual	During m/c setting	Tech. Data Sheet	Tech. Data Sheet	-	-	P	-		
		b) Anti rodent & termite additives	Major	Visual	Each loading			Reg./Sheet	-	P	V		
		b) Thickness	Major	Physical	Each length	Tech. Data Sheet	Tech. Data Sheet	Reg./Sheet	-	P	V		
		c) Overall diameter	Major	Physical	Each length	Tech. Data Sheet	Tech. Data Sheet	Reg./Sheet	-	P	V		
		d) Surface finish & colour of sheath	Major	Visual	100 %	Surface smooth & free from defects. Colour as per Tech. Data Sheet			-	-	P	-	
		e) Cable length verification	Major	Visual	Each length	Manufacturing Plan	Manufacturing Plan		-	-	P	-	
		f) Marking	Major	Visual	Each length	As per approved GTP/cross sectiona drawing		Reg./Sheet	-	P	V		
<b>C FINAL INSPECTION</b>													
1	Routine tests	a) High Voltage	Critical	Electrical	100 %	IS 7098/II/2011	IS 7098/II/2011	Test Report	-	P	V		
		b) Conductor Resistance	Critical	Electrical	100 %	IS 8130/84	IS 8130/84	Test Report	-	P	V		
		c) Partial Discharge	Critical	Electrical	100 %	IS 7098/II/2011	IS 7098/II/2011	Test Report	-	P	V		
		d) Impulse	Critical	Electrical	One sample per lot			Test Report		P	V		
		e) Armour Coverage	Critical	Physical	One sample per lot			Test Report		P	V		
		f) Physiacal Dimensions	Critical	Physical	One sample per lot			Test Report		P	V		
		g) Freely Strippable insulation screen (Strippability Test)	Major	Physical	One sample per lot	Factory Standard	Factory Standard	Test Report	-	P	V		
2	Stage Inspection	Wire Drawing	Major	Visual	100 %	Tech. Data Sheet	IS/IEC	Test Report	-	P	W	Stage Inspection shall be conducted subject to BRPL requirement	
		Extrusion process	Major	Visual	100 %	Tech. Data Sheet	IS/IEC	Test Report	-	P	W		
		Raw maerial inspection at factory	Major	Physical	100 %	Tech. Data Sheet	IS/IEC	Test Report	-	P	W		
		Wrapping of Aluminium	Major	Physical	100 %	Tech. Data Sheet	IS/IEC	Test Report	-	P	W		
		Tensile test for Aluminium	Major	Physical	100 %	Tech. Data Sheet	IS/IEC	Test Report	-	P	W		
3	Acceptance tests	a) Annealing test for copper	Major	Physical	Appendix A to IS 7098/II/2011, each lot sample basis	IS 8130/84	IS 8130/84	-	-	P	V	Verification of process records.	
		b) Tensile test for aluminium	Major	Physical		IS 8130/84	IS 8130/84	-	-	P	V		



**QUALITY ASSURANCE PLAN (QAP)  
FOR 11 kV H. T. CABLES**

S. NO.	COMPONENT & OPERATION	CHARACTERISTICS	CLASS	TYPE OF CHECK	QUANTUM OF CHECK	REFERENCE DOCUMENT	ACCEPTANCE NORMS	FORMAT OF RECORD	AGENCY			Remark	
									SV	MFR	BRPL		
1	2	3	4	5	6	7	8	9	10	11	12	13	
Legend : SV : Sub-Vendor of Cable Manufacturer, MFR : Cable Manufacturer, MPS : Material Purchase Specification, BRPL : BSES Rajdhani Power Ltd, P : Perform, W : Witness, V : Verification													
		c) Wrapping test for aluminium	Major	Physical		IS 8130/84	IS 8130/84	-	-	P	V	Tests N/A on finished conductor.	
		d) Conductor resistance test	Major	Electrical	Appendix A to IS 7098/II/2011, each lot sample basis	IS 8130/84	IS 8130/84	Test Report	-	P	W		
		e) Test for thickness of insulation & sheath	Major	Physical		IS 7098/II/2011 & Tech. Data sheet	IS 7098/II/2011 & Tech. Data sheet	Test Report	-	P	W		
		f) Hot set test for insulation	Major	Physical		IS 7098/II/2011	IS 7098/II/2011	Test Report	-	P	W		
		g) Tensile strength & Elongation at break of insulation & outer sheath	Major	Physical		IS 7098/II/2011 & IS 5831/84	IS 7098/II/2011 & IS 5831/84	Test Report	-	P	W		
		h) Partial discharge test	Critical	Electrical		IS 7098/II/2011	IS 7098/II/2011	Test Report	-	P	W		
		i) High voltage test	Critical	Electrical		IS 7098/II/2011	IS 7098/II/2011	Test Report	-	P	W		
		j) Insulation resistance (Volume resistivity) test	Major	Electrical		IS 7098/II/2011	IS 7098/II/2011	Test Report	-	P	W		
		k) Tests for dimension of armour wires/strips	Major	Physical		Each Lot Sample Basis	IS 3975, IS 10810 Pt. 36 & Tech. Data sheet		Test Report	-	P	W	
		l) Test for anti termite & anti rodent property of outer sheath	Major	Physical			Tech. Data Sheet	Tech. Data Sheet	Reg./Sheet	-	P	W	
		m) Rewinding of cable on drum	Major	Visual			To check cable appearance, drum appearance, cable winding, packing, embossing/printing/sequential marking		Reg./Sheet	-	P	W	
		n) Void & contamination test for insulation (Silicon Oil test)	Major	Physical				Reg./Sheet	-	P	W		
		o) Wafer boil test for extruded semi-conducting layers	Major	Physical				Reg./Sheet	-	P	W		
		p) Freely Strippable insulation screen	Major	Physical	Factory Standard		Factory Standard	Test Report	-	P	W		
		q) Water Penetration test (WPT) on core (i.e. Logitudinal Water Blocking Test)	Major	Physical	IEC:60502		IEC:60502	Test Report	-	P	W	<b>Test shall be conducted for leakage of water through conductor.</b>	
		r) Armour coverage	Major	Physical	As per data sheet & FS		As per data sheet & FS	Test Report	-	P	W		
		s) Ovality	Major	Physical	As per data sheet		As per data sheet	Test Report	-	P	W		
		t) Eccentricity	Major	Physical	As per data sheet		As per data sheet	Test Report	-	P	W		
		u ) Mass & uniformity & zinc coating on armour	Major	Physical	As per data sheet & FS	As per data sheet & FS	Test Report	-	P	W			



**QUALITY ASSURANCE PLAN (QAP)  
FOR 11 kV H. T. CABLES**

S. NO.	COMPONENT & OPERATION	CHARACTERISTICS	CLASS	TYPE OF CHECK	QUANTUM OF CHECK	REFERENCE DOCUMENT	ACCEPTANCE NORMS	FORMAT OF RECORD	AGENCY			Remark
									SV	MFR	BRPL	
1	2	3	4	5	6	7	8	9	10	11	12	13
<b>Legend : SV : Sub-Vendor of Cable Manufacturer, MFR : Cable Manufacturer, MPS : Material Purchase Specification, BRPL : BSES Rajdhani Power Ltd, P : Perform, W : Witness, V : Verification</b>												
		v ) Resistivity of Strip armour	Major	Electrical		As per data sheet & FS	As per data sheet & FS	Test Report	-	P	W	
		w ) Swelling height of water swellable tape	Major	Physical		As per data sheet & FS	As per data sheet & FS	Test Report	-	P	W	
		x ) Cable pulling eye strength test on one sample	Major	Physical		As per data sheet & FS	As per data sheet & FS	Test Report	-	P	W	
		y ) Flammability test	Major	Physical		As per IS-78098/II/2011	As per IS-78098/II/2011	Test Report	-	P	W	
		z) Impulse withstand test	Critical	Electrical		IS 7098/II/2011	IS 7098/II/2011	Test Report	-	P	W	
		z1) Ageing & Water absorption test(Gravimetric) on Insulation & Outer sheath	Major	Physical		IS 5831/84	IS 5831/84	Test Report	-	P	W	
		z2) Heating Cycle with Potential	Critical	Electrical	sample basis, once per PO			Test Report	-	P	W	
		z3) Raw Material Verification in all aspects	Major	Physical	Each Lot					P	W	
4	Type tests at vendor's works	a) Tests on conductor										
		i) Annealing test for copper	Major	Physical		IS 8130/84	IS 8130/84	-	-	P	V	Verification of process records. Tests N/A on finished conductor.
		ii) Tensile test for aluminium	Major	Physical		IS 8130/84	IS 8130/84	-	-	P	V	
		iii) Wrapping test for aluminium	Major	Physical		IS 8130/84	IS 8130/84	-	-	P	V	
		iv) Conductor resistance test	Major	Electrical		IS 8130/84	IS 8130/84	Test Report	-	P	V	
		b) Tests for armouring wires/strips										
		i) Dimensions of wire/strip	Major	Physical		IS 3975, IS 10810 Pt. 36 & Tech. Data sheet		Test Report	-	P	W	
		ii) Tensile strength & Elongation at break	Major	Physical		IS 3975	IS 3975	Test Report	-	P	W	Only for Steel wires/strips
		iii) Torsion test for wire	Major	Physical		IS 3975	IS 3975	Test Report	-	P	W	
		iv) Winding test for strip	Major	Physical		IS 3975	IS 3975	Test Report	-	P	W	
		v) Uniformity of zinc coating	Major	Chemical		IS 3975	IS 3975	Test Report	-	P	W	
		vi) Mass of zinc coating	Major	Chemical		IS 3975	IS 3975	Test Report	-	P	W	
		vii) Resistivity of wire/strip	Major	Electrical		IS 3975	IS 3975	Test Report	-	P	W	
		c) Test for thickness of insulation & sheath	Major	Physical		IS 7098/II/2011 & Tech. Data sheet	IS 7098/II/2011 & Tech. Data sheet	Test Report	-	P	W	
		d) Physical tests for insulation									W	
		i) Tensile strength & Elongation test	Major	Physical		IS 7098/II/2011	IS 7098/II/2011	Test Report	-	P	W	
		ii) Ageing in air oven	Major	Physical		IS 7098/II/2011	IS 7098/II/2011	Test Report	-	P	W	







**QUALITY ASSURANCE PLAN (QAP)  
FOR 11 kV H. T. CABLES**

S. NO.	COMPONENT & OPERATION	CHARACTERISTICS	CLASS	TYPE OF CHECK	QUANTUM OF CHECK	REFERENCE DOCUMENT	ACCEPTANCE NORMS	FORMAT OF RECORD	AGENCY			Remark
									SV	MFR	BRPL	
1	2	3	4	5	6	7	8	9	10	11	12	13
<b>Legend : SV : Sub-Vendor of Cable Manufacturer, MFR : Cable Manufacturer, MPS : Material Purchase Specification,</b>												
<b>BRPL : BSES Rajdhani Power Ltd, P : Perform, W : Witness, V : Verification</b>												
<b>Note</b>	<ol style="list-style-type: none"> <li>1. Checks specified above for Raw Material, In-Process and Final Inspection shall be as relevant to the specific cable construction.</li> <li>2. Number of samples shall be selected as per Factory Standard/Agreement wherever 'sample' is indicated for extent of check.</li> <li>3. Plant standards shall be followed in case Technical Data Sheet does not include requirements for characteristics to be checked.</li> <li>4. BRPL may witness Raw material and in process inspection in addition to Routine/Acceptance tests at any time/stage of manufacturing.</li> <li>5. BRPL's Inspector may randomly select a cable drum for type testing at vendor's works.</li> <li>6. For each of the offered lot for inspection, BRPL may randomly select one cable drum for testing of end cap "Destructive testing" to verify adhesion of sealing cap to cable outer sheath. Similarly, pulling eye shall be tested with 30N/mm<sup>2</sup> pressure.</li> <li>7. All factory Type Tests shall be Witnessed by BRPL</li> </ol>											

**Annexure- G****Testing and manufacturing process requirements w. r. t. TR- XLPE insulation**

All cables made with TR-XLPE Insulation should be tested and/or certified to meet the following performance parameters as per ANSI /ICEA S-94-649 after one year AWTT.

Property	Units	Requirements Values
Min. Avg. Electrical Breakdown Strength(qual. test)	kV/mm	$\geq 25$
Impulse Strength	kV/mm	$\geq 83$
Water Tree Length	Mm	0.25
Max. Bowtie Tree Density	(Number per 16.4 cu. cm)	Maximum 15 (0.12-0.25 mm range)

Manufacturing processes to produce high-quality cables with the following characteristics:

- Cure consistency with hot set/creep less than 100%
- No voids larger than 75 microns per 16.4 cubic cm
- No ambers larger than 250 microns per 16.4 cubic cm
- No contaminants larger than 125 microns and less than 5 between 50-125 microns per cubic 16.4 cubic cm tested.
- Neutral indent on cable is less than 375 microns
- Cable insulation concentricity greater than 90% tested
- No protrusions greater than 75 microns at the conductor shield and 125 microns at the insulation shield

Annexure-H: Deviation Format

Sl. No.	Document Name	Clause No.	Deviation	Reason	Merit to BRPL

# BSES

## Technical Specification for LT POWER CABLE WITH FRLS OUTER SHEATH (Single & Multi-Core)

Specification no – SP-EWLP-01-R5

Prepared By		Reviewed By		Approved By		Rev /Pages	Date
Name	Sign	Name	Sign	Name	Sign		
Rohit Patil	 02/03/2020	Amit Tomar	 02.03.2020	K. Sheshadri	 02/03/2020	R5/ 22	02.03.2020

TECHNICAL SPECIFICATION OF LT POWER CABLE

INDEX

**Contents**

RECORD OF REVISION .....	3
1.0 SCOPE OF SUPPLY .....	4
2.0 CODES & STANDARDS .....	4
3.0 CABLE DESIGN .....	6
4.0 CABLE DRUM .....	7
5.0 PACKING , SHIPPING , HANDLING & STORAGE .....	8
6.0 QUALITY ASSURANCE , TESTING & INSPECTION .....	9
7.0 DRAWING, DATA & MANUALS .....	10
8.0 PROGRESS REPORTING .....	10
9.0 DEVIATION .....	11
10.0 TECHNICAL PARTICULARS .....	12
11.0 ANNEXURE – A .....	13
12.0 ANNEXURE – B .....	14
13.0 ANNEXURE- C .....	18
14.0 ANNEXURE – D .....	21
15.0 ANNEXURE – E .....	22

## TECHNICAL SPECIFICATION OF LT POWER CABLE

## RECORD OF REVISION

Sr. No.	Revision No.	Item/Cl. No.	Nature of Change	Approved By
1	R2	2.0	National & International Standards added	VP
2	R2	3.6 (c)	UV resistance test shall be carried out on all size of cable	VP
3	R2	6.4	Type tests Cl. Changed.	VP
4	R2	4.1 & 4.2	Cable Drum as per IS 10418	VP
5	R2	4.3	For 2C X 10 mm <sup>2</sup> cable drum length – 1000 +/- 5% Mtr	VP
6	R3	ANNEXTUE- C	New size cable added 1.1 kV 1CX1000 mm <sup>2</sup>	KS
7	R4	3.6	Drum number laser printing on every meter of cable outer sheath	KS
8	R5	2.0	National & International Standards added	KS
9	R5	3.6	FRLS outer sheath	KS
10	R5	3.9	FRLS outer sheath properties	KS
11	R5	6.5	Acceptance Test	KS
12	R5	Annexure-E	Sub vendor list	KS

Prepared By

  
Rohit Patil  
02/03/2020

Reviewed By

  
Amit Tomar  
02/03/2020

Approved By

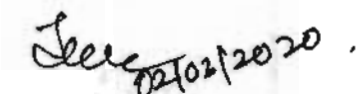
  
K. Sheshardri  
02/02/2020

**TECHNICAL SPECIFICATION OF LT POWER CABLE****1.0 SCOPE OF SUPPLY**

The specification covers design, manufacture, shop testing, packing and delivery of 1100 Volts grade, Aluminium conductor XLPE insulated multi core power cables.

**2.0 CODES & STANDARDS**

The cables shall be designed, manufactured and tested in Accordance with the following Indian & IEC standards.

2.1	IS- 7098 (Part-1)	Cross linked polyethylene insulated PVC sheathed cables for working voltages upto and including 1100V.
2.2	IS- 6474	Polyethylene insulation & sheath of electric cables.
2.3	IS- 5831	PVC insulation and sheath of electrical cables.
2.4	IS : 10810	Methods of tests for cables.
2.5	IS : 8130	Conductors for insulated electrical cables and flexible cords.
2.6	IS : 3975	Low carbon galvanized steel wires, formed wires and tapes for armouring of cables.
2.7	IS- 4026	Aluminum ingots, billets and wire bars (EC grade)
2.8	IS-5484	EC Grade aluminium rod produced by continuous casting and rolling
2.9	IS : 10418	Specification for drums for electric cables.
2.10	IS : 3961	Recommended current ratings for cables.
2.11	IS:1255	Installation and Maintenance of power cables upto and including 33 kV rating.
2.12	IS:4826	Specification for hot-dipped galvanized coatings on round steel wires
2.13	IS:1717	Metallic Materials – Wire – Simple torsion test
2.14	IEC 60228	Conductors of insulated cables. Guide to the dimensional limits of circular conductors.
2.15	IEC 60331	Fire resisting characteristics of electric cables.
2.16	IEC 60332 – 3	Tests on electric cables under fire conditions. Part 3: Tests on bunched

**TECHNICAL SPECIFICATION OF LT POWER CABLE**

		wires or cables.
2.17	IEC 60502	Extruded solid dielectric insulated power cables for rated voltages from 1kV to 30 kV.
2.18	IEC 60754 – 1	Test on gases evolved during combustion of materials from cables. Part 1: Determination of the amount of halogen acid gas evolved during combustion of polymeric material taken from cables.
2.19	IEC 60811	Common test methods for insulating and sheathing materials of electric cables
2.20	IEC 60885	Electric test methods for electric cables
2.21	IEC 60304	Standard colours for insulation for low frequency cables and wires.
2.22	IEC 60227	PVC insulated cables of rated voltages up to and including 460/760 V.
2.23	IEC 1034	Measurement of smoke density of electric cables burning under defined conditions
2.24	ASTMD 2843 (R5)	Standard Test Method for density of Smoke from the burning or decomposition of cables
2.25	ASTM 2863 (R5)	Standard Test Method for measuring of minimum oxygen concentration
2.26	IEC 60754-1 (R5)	Test on gases evolved during combustion of materials for cables. Part 1 – Determination of the Halogen Acid gas Content
2.27	IS 1554 part 1	Specification for PVC insulated (Heavy duty) Electric cable

**TECHNICAL SPECIFICATION OF LT POWER CABLE**

**3.0 CABLE DESIGN**

Description of each item mentioned in the specification (the text, BOQ, GTP or any site specific requirement) shall be followed along with IS: 7098 – P1

3.1	Conductor	<p>a) Electrolytic Grade Stranded Aluminium Conductor  b) Grade : H2 as per IS: 8130/1984  c) Class 2  d) Chemical Composition as per IS 4026  e) Shape &amp; Size:</p> <table border="1" data-bbox="613 709 1502 1016"> <thead> <tr> <th>S.no.</th> <th>Shape</th> <th>Single core</th> <th>Multi core</th> </tr> </thead> <tbody> <tr> <td>1</td> <td>Compacted Circular</td> <td> <ul style="list-style-type: none"> <li>• 1cx300</li> <li>• 1cx630</li> <li>• 1cx1000</li> </ul> </td> <td>2cx10</td> </tr> <tr> <td>2</td> <td>Sector</td> <td>---</td> <td> <ul style="list-style-type: none"> <li>• 2cx25</li> <li>• 4cx25</li> <li>• 4cx50</li> <li>• 4x150</li> </ul> </td> </tr> </tbody> </table>	S.no.	Shape	Single core	Multi core	1	Compacted Circular	<ul style="list-style-type: none"> <li>• 1cx300</li> <li>• 1cx630</li> <li>• 1cx1000</li> </ul>	2cx10	2	Sector	---	<ul style="list-style-type: none"> <li>• 2cx25</li> <li>• 4cx25</li> <li>• 4cx50</li> <li>• 4x150</li> </ul>
S.no.	Shape	Single core	Multi core											
1	Compacted Circular	<ul style="list-style-type: none"> <li>• 1cx300</li> <li>• 1cx630</li> <li>• 1cx1000</li> </ul>	2cx10											
2	Sector	---	<ul style="list-style-type: none"> <li>• 2cx25</li> <li>• 4cx25</li> <li>• 4cx50</li> <li>• 4x150</li> </ul>											
3.2	Insulation	Extruded XLPE as per IS : 7098 part-1												
3.3	Core Identification	As per Cl.10 of IS 7098 part-1												
3.4	Inner Sheath	For 1.1 kV 2CX10 , 2CX25 Pressurized Extruded For other cable Extruded Inner Sheath of black PVC type ST-2 (IS 5831-1984)												
3.5	Armour	<p>a) For 2C X 10 mm<sup>2</sup> – Galvanized Steel round wire.  b) For all sizes above 10 mm<sup>2</sup>-Galvanized Steel Strip  c) Not applicable for single core cables of size 300 , 500 , 630 &amp; 1000 mm<sup>2</sup>  d) Minimum area of coverage of armouring shall be 90%  e) The breaking load of armour joint shall not be less than 95% of that armour wire / strip  f) Zero negative tolerance for thickness of armour strip shall be as per IS:3975  g) Zinc rich paint shall be applied on strip/wire and its joint surface.</p>												
3.6	Outer Sheath	<p>a) Extruded FRLS (R5) outer sheath of PVC (ST-2) shall be as per IS:5831  b) Colour : Yellow (For multi core cables)</p>												



**TECHNICAL SPECIFICATION OF LT POWER CABLE**

		<p>Black (For single core 300,500, 630 &amp; 1000 mm<sup>2</sup>)</p> <p>c) FRLS(R5) Outer sheath of all the LT cables shall be UV resistant; as these cables are laid in air exposed to sun. Bidder to ensure the same for these requirements supported by required test.</p> <p>d) Shape of the cable over the outer sheath shall be circular, when manufactured/completed.</p> <p>e) The FRLS (R5) outer Sheath shall be embossed with following minimum text:</p> <ol style="list-style-type: none"> <li>The voltage designation</li> <li>Type of construction /cable code (For e.g. A2XWY/A2XFY)</li> <li>Manufacture name/Trade mark</li> <li>Number of Cores and nominal cross section area of conductor</li> <li>Name of buyer i.e BRPL (BSES Rajdhani Power Ltd.)</li> <li>Month &amp; year of manufacturing</li> <li>IS reference , i.e. IS:7098</li> <li>P.O No. and Date</li> <li>Font size shall be 5/5mm</li> <li>ISI mark</li> </ol> <p>The embossing shall be progressive, automatic, in line and marking shall be legible and indelible. Following points shall be laser printed on every meter of cable</p> <ol style="list-style-type: none"> <li>Progressive (Sequential) length of cable at every meter, starting from zero for every drum. Colour filled in for the progressive marking, shall be with proper contrast in colouring.</li> <li>Drum number marking on every meter of the cable length</li> </ol>
3.7	Bending Radius	Bending Radius of cable shall comply to IS:1255
3.8	Sealing of cable end	Both ends of the cable shall be sealed by means of non-hygroscopic heat shrinkable HDPE caps
3.9	FRLS Properties (R5)	<p>Oxygen Index : Not less than 29% as per ASTM 2863</p> <p>Temperature Index : 250 Deg C at Oxygen Index 21 (when tested as per ASTM D 2863)</p> <p>Max Acid Gas Generation – Not more than 20% as per IEC -60754-1</p> <p>Light Transmission - Minimum 40% when tested as per ASTM D 2843 (Smoke Density rating shall be max 60%)</p> <p>Flammability Test – As per IEC 60332-III, Cat – B, IEC 60332- I, IS- 10810 – Part 53, IS:10810 – Part 61 &amp; 62 (Category A)</p>

**4.0 CABLE DRUM**

4.1	Reference Standard	Cable drum shall comply with IS: 10418.
4.2	Type of Drum	Wooden drums with anti termite treatment. (The drums shall be provided with M.S spindle plate and nut-bolts arrangement as per IS : 10418 )

**TECHNICAL SPECIFICATION OF LT POWER CABLE**

4.3	Drum Length & Tolerance	For 1.1 KV 2C X 10 mm <sup>2</sup> Cable - 1000+/-5% Mtr For all size above 10 mm <sup>2</sup> Cables - 500 +/-5% Mtr
4.4	Overall Tolerance	-2 % for the total cable length for the entire order.
4.5	Short Length of Cable	a) Minimum Acceptance short length shall be 1% of the total ordered quantity and no length shall be less than 500 mtrs for 2C X 10 mm <sup>2</sup> cable & 250 mtr for all sizes above 10 mm <sup>2</sup> . Manufactures shall be taken prior approval from BRPL Engineering for any short length supply. Short length will be accepted in last lot. b) Manufacture shall not be allowed to put two cable pieces of different short length in same cable drum
4.6	Preventive Measure for cable Drum	a) The surface of the drum and outer most cable layer shall be covered with water proof layer b) Ferrous part of wooden drum shall be treated with suitable rust preventive paint/coating to minimize rusting during storage.
4.7	Drum Identification Labels	a) Drum identification number b) Cable voltage grade c) Cable code (eg. A2XFY/A2XWY) d) Number of cores and cross sectional area e) Cable quantity i.e cable length (Meters) f) Purchase order number, date & SAP item code g) Total weight of cable and drum (kg) h) Manufacture's and Buyer's name i) Month & year of manufacturing j) Direction of rotation of drum; an arrow and suitable accompanying wording shall be marked on one end of the reel indicating the direction in which it should be rolled. k) Cable length final end-marking (i.e reading at the inner end and reading at the outer end, just before packing shall be marked on the drum.

**5.0 PACKING , SHIPPING , HANDLING & STORAGE**

5.1	Shipping information Plan	The seller shall be give complete shipping information concerning the weight ,size of each package
5.2	Transit Damage	The seller shall be held responsible for all transit damage due to improper packing/inside cable damaged found in store/site
5.3	Cable Drum Handling	The drum shall be with M.S spindle plate( with nut –bolts) of adequate size to suit the spindle rod , normally required for handling the drums , according to expected weight of the cable drums as per IS:10418

TECHNICAL SPECIFICATION OF LT POWER CABLE

**6.0 QUALITY ASSURANCE , TESTING & INSPECTION**

All the tests shall be carried out in accordance with IEC / IS standards.

6.1	Quality Assurance Plan	As per Annexure – E. In event of order Manufacturer has to Submit the signed copy of QAP.
6.2	Inspection hold points	AS per QAP
6.3	Routine Test	a) Measurement of Electrical Resistance b) HV test with power frequency AC voltage
6.4	Type Test	(a) Cables must be of type tested quality. Type test reports shall be submitted for the type, size and rating of cable offered along with bid. Type test shall not be more than 5 years old. In the event of type test being older than 5 years, bidder has to conduct the same at CPRI/ERDA, approved Lab without commercial implication to BRPL  (b) Bidder supplying cable to BRPL for the first time shall have to conduct type test, Chemical Composition & UV resistance test on sample randomly selected from lot in event of order from CPRI/ERDA.  (c) UV resistance test to be carried out on one sample from CPRI/ERDA/NABL Accredited Lab as per ASTM standard (sample shall meet minimum 80% retention after exposure of 21 days as per ASTM standard).
6.5	Acceptance Test (Shall be conducted as per Cl.15.2 of IS 7098 Part-1 & IS 1554 part 1 for each lot of cable)(R5)	a) For cable sizes up to 50 mm <sup>2</sup> – one sample for chemical composition and purity test of aluminium shall be conducted upto r 100km of ordered quantity and multiple thereof.  b) For cable sizes above 50 mm <sup>2</sup> – one sample for chemical composition and purity test of aluminium shall be conducted upto 50km of ordered quantity and multiple thereof.  c) Chemical composition and purity test of aluminium shall be conducted from the lot offered to BRPL on each size involved in the purchase order. Test shall carried out at NABL accredited third party lab without any price implication to BRPL.  d) The sample will be selected either during acceptance test or after receipt of cable in BRPL Stores.
6.6	Inspection	a) The buyer reserves the right to witness all tests specified on

**TECHNICAL SPECIFICATION OF LT POWER CABLE**

		<p>completed cables</p> <p>b) The buyer reserves the right to inspect cables at the seller's works at any time prior to dispatch either in finished form or during manufacturing, to prove compliance with the specifications.</p> <p>c) In-process and final inspection call intimation shall be given in 10 days advance to purchaser/CES.</p>
6.7	Test Certificates	Complete test certificates (routine & acceptance tests) need to be submitted along with the delivery of cables.

**7.0 DRAWING, DATA & MANUALS**

7.1	To be submitted along with bid	<p>The vendor has to submit:</p> <p>a) Cross section drawing of cable</p> <p>b) Completely filled GTP</p> <p>c) Type test certificates</p> <p>d) Complete cable catalogue and manual along with the bid</p> <p>e) Copy of BIS licence</p>
7.2	After award of contract	Within 7 days, the seller has to submit four sets of above mentioned drawings for buyer's approval along with the signed copy of QAP (Annexure – E).
7.3	Final As Built	6 sets hardcopy + One Soft copy of all documents including type test certificates

**8.0 PROGRESS REPORTING**

8.1	Outline Document	To be submitted for purchaser approval for outline of Production-inspection, testing-inspection, packing, dispatch, documentation programme.
8.2	Detailed Progress Report	<p>To be submitted to purchaser once a month containing</p> <p>(i) Progress on material procurement</p> <p>(ii) Progress on fabrication (As applicable)</p> <p>(iii) Progress on assembly (As applicable)</p> <p>(iv) Progress on internal stage inspection</p> <p>(v) Reason for any delay in total programme</p>

**TECHNICAL SPECIFICATION OF LT POWER CABLE**

		(vi) Details of test failures if any in manufacturing stages. (vii) Progress on final box up constraints/forward path.
--	--	---

**9.0 DEVIATION**

- a) Deviations from this specification shall be listed separately by bidder clause wise (format given below) along with optional offer and has to submit the list along with bid/quotation. BRPL will review the deviations and if BRPL is agreed with the deviation, seller has to take written confirmation from BRPL on deviation during tender evaluation.
- b) In the absence of any separate list of deviations from the bidders with bid as well as written confirmation from BRPL on deviations, it will be assumed by the Buyer that the Seller complies with the Specification fully.
- c) Any deviations mentioned in any other submitted bid documents (i.e.in filled GTP, Catalog, BRPL old approval, buyer's/seller's standards etc) by seller without separate deviation sheets will not consider as a deviation from this tech spec at any stage of contract.

Deviation sheet format.

Sl. No.	Document Name	Clause No.	Deviation	Reason	Merit to BRPL

**TECHNICAL SPECIFICATION OF LT POWER CABLE**

**10.0 TECHNICAL PARTICULARS**

- a. GTP - As per Annexure-B for Multi-core cables.
- b. GTP - As per Annexure-C for Single-core cables (300, 500, 630 & 1000 mm<sup>2</sup> cables).
- c. Armour Coverage Percentage – As per Annexure-D.
- d. Quality Assurance Plan – As per Annexure-E.
- e. List of sub-vendors for Raw Material – As per Annexure-F.

**TECHNICAL SPECIFICATION OF LT POWER CABLE****11.0 ANNEXURE – A****SCOPE & PROJECT SPECIFICATION DETAILS****1.0.0 Scope**

1.0.0	Scope	Design, manufacture, testing & supply of L.T Power Cables.
2.0.0	Delivery Schedule	To be filled up as per purchase requisition.

**2.0.0 Document Submission**

Submission of drawings, calculations, catalogues, manuals, test reports shall be as follows

	Along with offer	For Approval after award of contract	Final after approval	Remarks
Drawings	2 copies (Typical Drawings)	2 Copies	2 Copies + 1 soft copy in CD	See Clause 7.0 for details of required drawings
Calculations	2 Copies (Typical)	2 Copies		
Catalogues	1 Copy			Type test and sample routine test reports
Type Test Report	2 Copies			

**TECHNICAL SPECIFICATION OF LT POWER CABLE**

**12.0 ANNEXURE – B**

**GUARANTEED TECHNICAL PARTICULARS (Multi-core)**

(Standard Cable sizes are 2c x10, 2c x25, 4c x25, 4c x50, 4C X 95, 4c x150, 4cx300)

For each size /rating separate GTP need to be furnished

Sr. No.	Description	Buyer's Requirement	Seller's data
	Manufacture Contact Person & Number		
	Purchase Req. No.	.....	
	Guarantee Period: ( Min )	60 Months (from date of commissioning) / 66 months (from date of receipt at purchaser's store) whichever is earlier	
	Applicable IS / IEC Standard followed by vendor	As mentioned in the clause no – 2.0	
1	Make	...	
2	Type (as required by purchaser)		
A	For 2CX10Sqmm	A2XWY	
B	For Sizes above 10 mm <sup>2</sup>	A2XFY	
3	Voltage Grade (kV)	1.1	
4	Maximum Conductor temperature		
A	Continuous	90°C	
B	Short time	250°C	
5	Conductor		
A	Material and Grade	As per Cl.3.1	
B	Make of Al	Ref Annexure E	
C	Size (mm <sup>2</sup> )	..... mm <sup>2</sup>	
D	Min no. of wires in each conductor (Nos.)	As per Manufacturer Standard	
E	Min Dia. of wires in each conductor before compaction (mm)	As per Manufacturer Standard	



**TECHNICAL SPECIFICATION OF LT POWER CABLE**

F	Shape of Conductor	As per Cl.3.1 (e)	
G	Diameter over conductor (mm)	.....	
H	Maximum Conductor resistance at 20 ° C (Ohm/Km)	As per Table 2 of IS 8130	
6	Insulation		
A	Insulation Material	As per Cl. 3.2	
B	Nominal thickness (mm)	As per Table 3 of IS 7098 Part-1	
C	Diameter over Insulation (mm) Approx.	.....	
D	Make of insulation compound	Ref: Annexure E	
7	Inner Sheath		
A	Material and Type	As per Cl. 3.4	
B	Minimum thickness	As per Table 5 of IS 7098 Part-1	
C	Approx. dia. Over sheath (mm)	.....	
8	Galvanized Steel Armour	as per purchaser's site - specific condition	
A	Material		
a)	For 2CX10 mm <sup>2</sup>	G.I.Wire	
(i)	Wire Dia (mm)	1.4+/-0.040	
(ii)	No. of wires	As per Manufacturer Standard	
b)	For sizes above 10 mm <sup>2</sup>	G.I.Strip	
(i)	Strip size ( Width and Thickness)	4x0.8 (Zero negative tolerance for thickness)	
(ii)	No. of Strips	As per Manufacturer Standard	
B	Area covered by Armour	Min 90% and calculations shall be strictly as per Annexure D	
C	Dia. over Armour – Approx.(mm)	.....	
9	Outer Sheath (FRLS)		
A	Material and Type	As per Cl. 3.6	

**TECHNICAL SPECIFICATION OF LT POWER CABLE**

B	Minimum Thickness	As per Table 8 of IS 7098 Part-1	
C	Colour	Yellow	
D	Embossing Details	As per Cl.3.6 (f)	
10	Approx. overall dia. (mm)	.....	
11	Overall order tolerance	- 2 % for the total cable length for the entire order	
12	Cable Drum		
A	Type of Drum	Wooden	
B	Drum Length & tolerance	As per Spec. Cl. 4.3 & 4.4	
C	Marking on Drum	As per Spec. Cl. 4.7	
D	Drums provide with MS Spindle plate & nut bolts arrangement (as per IS:10418)	Required	
13	End Cap	Required	
14	Weights	.....	
a)	Net Weight of cable ( Kg/Km. ) – Approx		
b)	Weight of empty drum	Kg	
c)	Weight of cable with drum	Kg	
15	Continuous current rating for standard I.S condition laid direct		
a)	In ground 30° C	Amps	
b)	In duct 30° C	Amps	
c)	In Air 40° C	Amps	
16	Short circuit current for 1 sec of Conductor (kAmp)	.....	
17	Electrical Parameters at Maximum operating temperature:		
A	AC Resistance	Ohm/Km	
B	Reactance at 50 C/s	Ohm/Km	
C	Impedance	Ohm/Km	
D	Capacitance	Micro farad / Km	
18	Recommended minimum bending radius	..... x O/D	

**TECHNICAL SPECIFICATION OF LT POWER CABLE**

19	Derating factor for following Ambient temperature in	Ground / Air	
a)	At 30° C		
b)	At 35° C		
c)	At 40° C		
d)	At 45° C		
e)	At 50° C		
20	Group factor for following Nos. of cables laid	Touching / Trefoil	
a)	3 Nos.		
b)	4 Nos.		
c)	5 Nos.		
d)	6 Nos.		
21	Process of Cross linking of Polyethylene	Dry/ Sioplas Cure	
22	Type test	Is copy of latest valid TTR for respective Sizes enclosed? Yes / No	
23	FRLS Properties (R5)	As per IS 1554, Part-1	
	Oxygen Index	As per IS 1554, Part	
	Temperature Index	As per IS 1554, Part	
	Max Acid Gas Generation	As per IS 1554, Part	
	Light Transmission / Smoke Density	As per IS 1554, Part	

**TECHNICAL SPECIFICATION OF LT POWER CABLE**

**13.0 ANNEXTURE- C**

**GUARANTEED TECHNICAL PARTICULARS (Single Core)**

(Separate GTP needs to be furnished for 300, 500, 630 & 1000 mm<sup>2</sup> cables)

S.No.	Description	Buyer's Requirement	Seller's data
	Manufacture Contact Person & Number		
	Purchase Req. No.	.....	
	Guarantee Period: ( Min )	60 Months (from date of commissioning) / 66 months (from date of receipt at purchaser's store) whichever is earlier	
	Applicable IS / IEC Standard followed by Vendor	As mentioned in the clause no-2.0	
1	Make	.....	
2	Type	A2XY (Un-armoured)	
3	Voltage Grade (kV)	1.1kV	
4	Maximum Conductor temperature		
A	Continuous	90°C	
B	Short time	250°C	
5	Conductor		
A	Material and Grade	As per Cl.2.1.1	
B	Size (mm <sup>2</sup> )	300 / 500 / 630 / 1000 mm <sup>2</sup>	
C	Min no. of wires in each conductor (Nos.)	As per Manufacturer Standard	
D	Min Dia. of wires in each conductor before compaction (mm)	As per Manufacturer Standard	
E	Shape of conductor	Compacted Circular	
F	Diameter over conductor (mm)	.....	
G	Maximum Conductor resistance at 20 ° C (Ohm/Km)	As per Table 2 of IS 8130	
H	Make of Al	Ref Annexure E	
6	Insulation	As per Table 3 of IS 7098	

**TECHNICAL SPECIFICATION OF LT POWER CABLE**

		Part-1	
A	Insulation Material	As per Cl. 3.2	
B	Nominal thickness (mm)		
(i)	For 1Cx300 mm <sup>2</sup>	1.8 mm	
(ii)	For 1Cx500 mm <sup>2</sup>	2.2 mm	
(iii)	For 1Cx630 mm <sup>2</sup>	2.4 mm	
iv)	For 1Cx1000 mm <sup>2</sup>	2.8 mm	
C	Diameter over Insulation (mm) Approx.	.....	
D	Make of insulation compound	Ref: Annexure E	
7	Inner Sheath	Not applicable	
8	Armour	Not applicable	
9	FRLS Outer Sheath (R5)		
A	Material and Type	As per Cl. 3.6	
B	Minimum Thickness	As per Table 8 of IS 7098 Part-1	
C	Colour	Black	
D	Embossing Details	As per Cl.3.6 (f)	
10	Approx. overall dia. (mm)	.....	
11	Overall order tolerance	-2 % for the total cable length for the entire order	
12	Cable Drum		
A	Type of Drum	Wooden	
B	Drum Length & tolerance	As per Spec. Cl. 4.3 & 4.4	
C	Marking on Drum	As per Spec. Cl. 4.7	
D	Drums provide with MS Spindle plate & nut bolts arrangement (as per IS:10418)	Required	
13	End Cap	Required	
14	Weights	.....	
a)	Net Weight of cable ( Kg/Km. ) – Approx		
b)	Weight of empty drum	Kg	
c)	Weight of cable with drum	Kg	
15	Continuous current rating for standard I.S condition laid direct		

**TECHNICAL SPECIFICATION OF LT POWER CABLE**

a)	In ground 30° C	Amps	
b)	In duct 30° C	Amps	
c)	In Air 40° C	Amps	
16	Short circuit current for 1 sec of Conductor (kAmp)	.....	
17	Electrical Parameters at Maximum operating temperature:		
A	AC Resistance	Ohm/Km	
B	Reactance at 50 C/s	Ohm/Km	
C	Impedance	Ohm/Km	
D	Capacitance	Micro farad / Km	
18	Recommended minimum bending radius	..... x O/D	
19	Derating factor for following Ambient temperature in	Ground / Air	
a)	At 30° C		
b)	At 35° C		
c)	At 40° C		
d)	At 45° C		
e)	At 50° C		
20	Group factor for following Nos. of cables laid	Touching / Trefoil	
a)	3 Nos.		
b)	4 Nos.		
c)	5 Nos.		
d)	6 Nos.		
21	Process of Cross linking of Polyethylene	Dry/ Sioplas Cure	
22	Type test	Is copy of latest valid TTR for respective Sizes enclosed? Yes / No	
23	FRLS Properties (R5)		
	Oxygen Index	As per IS 1554, Part	
	Temperature Index	As per IS 1554, Part	
	Max Acid Gas Generation	As per IS 1554, Part	

## TECHNICAL SPECIFICATION OF LT POWER CABLE

Light Transmission / Smoke Density

As per IS 1554, Part

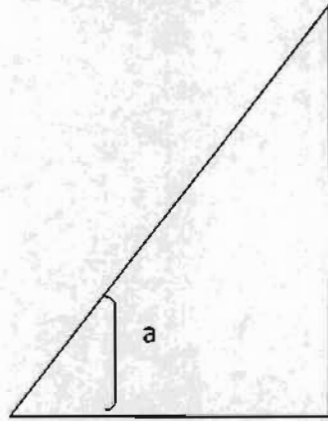
**14.0 ANNEXTURE – D**  
**ARMOUR COVERAGE PERCENTAGE**

$$\text{Percent coverage} = \frac{N \times d}{W} \times 100$$

Where

N = number of parallel wires / Strips

d = diameter of wire / width of formed wires

W =  $\pi \times D \times \cos a$ ,

D = diameter under armour

a = angle between armouring wire / formed wires and axis of cable

$\tan a = \pi \times D / C$ , and

C = lay length of armouring wires / formed wires.

Min 90% armour coverage shall be provided both in case of wires and strips.

The gap between armour wires / formed wires shall not exceed one armour wire / Formed wire space and there shall be no cross over / over-riding of armour wire / Formed wire. So, the minimum area of coverage of armouring shall be 90%.

## TECHNICAL SPECIFICATION OF LT POWER CABLE

## 15.0 ANNEXTURE - E

## LIST OF SUB-VENDORS

For critical items

Sr. No.	Description of Material	Sub-Vendors
1	E.C Grade Aluminium Rod	Bharat Aluminium Co. Ltd. (BALCO) Hindustan Aluminium Co. Ltd. (HINDALCO) National Aluminium Co. Ltd. (NALCO)
2	XLPE Compound	Kkalpana Industries Ltd. KLJ Polymers and Chemicals Ltd. Dow Chemical, U.S.A Borealis, Sweden Hanwha, Seoul, South Korea
3	PVC Compound (R5)	Kkalpana Industries Ltd. KLJ Polymers and Chemicals Ltd. Universal SCJ Plastic Sriram Polytech Shri Ram Vinyl, Kota
4	GI Strip (R5)	Tata Balaji Systematic Mica Wires Pvt Ltd. Bansal Industries





**Technical Specification**  
**For Heat Shrinkable And Cold Shrinkable**  
**Straight Through Jointing Kit**  
**(11 kV, 33 kV, 66 kV XLPE Insulated Cables)**

Specification no – SP-HCSTJ-03-R2

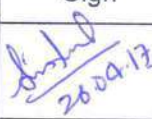
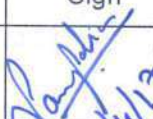
Prepared by		Reviewed by		Approved by		Rev	Date
Name	Sign	Name	Sign	Name	Sign		
Pronab Bairagi		Amit Tomar	 26.04.17	Vijay Panpalia	 26/4/17	R2	26/04/2017

**Technical Specification For Heat Shrinkable And Cold Shrinkable Straight Through Jointing Kit (11 kV, 33 kV, 66 kV XLPE Insulated Cables)****Index**

Record of Revision .....	3
1.0.0 Scope of work.....	4
2.0.0 Codes & standards .....	4
3.0.0 Cable Construction .....	5
4.0.0 Straight-Through Joints (STJ).....	6
5.0.0 Quality Assurance Plan (QAP) .....	12
6.0.0 Deviations.....	12
7.0.0 Delivery .....	13
8.0.0 Inspection Expenses .....	13
9.0.0 Failure Analysis and Penalty .....	13
Annexure - A: Guaranteed Technical Particulars (GTP).....	14
Annexure - B: Kit Content Table (KCT) .....	16
Annexure - C: Routine and Acceptance Test .....	17
Annexure - D: Deviation Sheet.....	18
Annexure - E: Service Conditions .....	18
Annexure - F: Aluminium crimping-type Ferrule for compacted circular conductor only for Heat Shrink joints .....	19
Annexure – G: Strip type GI canister (V.B. Can) for joint protection only for Heat Shrink Joint... ..	20
Annexure – H : Job card Details .....	21
Annexure – I: SOP for jointing work .....	22
Annexure – J: Joint Marker.....	24

**Technical Specification For Heat Shrinkable And Cold Shrinkable Straight Through Jointing Kit (11 kV, 33 kV, 66 kV XLPE Insulated Cables)****Record of Revision**

<b>Item/Clause No.</b>	<b>Change in Specification</b>	<b>Approved By</b>	<b>Rev</b>
4.1.12	GPS Coordination		01
4.5.1b	Type Test		01
Annexure-H	Job Card		01
Annexure-I	SOP		01
3.1.12	HTAB Cable Jointing and Termination Kit		01
4.1.13	Hydraulic Crimping		01
4.1.14	Coffin for completed joint and Joint Marker		02
3.0.0	66kV , 3CX300 Cable Joint (Including OFC Joint)		02
3.0.0	11kV , 3CX400 Cable Jointing kit		02
4.1.15	Electronic Ball Marker for 33kV and 66kV Cable Joint		02
8.0.0	Inspection Expenses		02
9.0.0	Failure Analysis and Penalty		02

**Technical Specification For Heat Shrinkable And Cold Shrinkable Straight Through Jointing Kit (11 kV, 33 kV, 66 kV XLPE Insulated Cables)****1.0.0 Scope of work**

- A. Heat Shrinkable / Cold shrinkable Straight Joint Kits (hereinafter briefly referred to as “STJ Kits”), suitable for 11 kV, 33 & 66kV XLPE cables, shall be designed, manufactured, tested, packed and delivered by the Vendor, as per Purchaser’s requirements.
- B. Supervision, during installation of joints at site if mentioned in the order.
- C. During post-installation period, if a joint fails at site, the vendor shall depute a technical team to site for a root-cause analysis of the failure of the joint, in the presence of BSES officials. An Analysis Report shall then be submitted for BSES’s review and approval. If this report concludes the cause of failure as due to a design/manufacturing defect in a component, then vendor shall replace all such components in the entire stock available with BSES.

**2.0.0 Codes & standards****2.1.0 National Standards:**

<b>S No.</b>	<b>Standard Number</b>	<b>Title</b>
2.1.1	IS- 13573: 2011	Joints & Terminations of Polymeric Cables for working voltages from 6.6 kV up to and including 33 kV Performance Requirements and Type Tests
2.1.2	IS- 7098: Part 2:1985	Cross-linked Polyethylene (XLPE) Insulated PVC sheathed cables: Part 2 - For working voltages from 3.3 kV up to and including 33 kV
	IS- 7098: Part 3:1993	Cross-linked polyethylene insulated thermoplastic sheathed Cables specification: Part 3 - For working voltages from 66 kV up to and including 220 KV
2.1.3	IS- 10810: 1984	Methods of test for cables

**2.1.1 International Standards:**

<b>S No.</b>	<b>Standard Number</b>	<b>Title</b>
2.2.1	EA TS - 09-13	Electricity Association - Technical Specification – 09 – 13 Material component for use in Electric Power Cable Termination & Joints for System voltage above 1kV up to 36 kV
2.2.2	IEC - 60183	Guide to the selection of high voltage cables
2.2.3	IEC - 885 Part 1 to 3	Electric test methods for electric cables
2.2.4	IEC - 60502 - 4	Power Cable Accessories for XLPE Cables above 3kV & up to 30 kV Test methods
2.2.5	IEC - 60840	Power cable with extruded insulation and their accessories for rated voltage above 30 kV (Um=36 kV) up to 150 kV (Um=170 kV) - test methods and requirements.

**Technical Specification For Heat Shrinkable And Cold Shrinkable Straight Through Jointing Kit (11 kV, 33 kV, 66 kV XLPE Insulated Cables)**

### 3.0.0 Cable Construction

Normal sizes of XLPE cables used in BSES system and the construction features of these cables are indicated below:

- 11kV, 3-core x 150 sq mm AL
- 11kV, 3-core x 300 sq mm AL
- 11kV, 3-core x 400 sq mm AL
- 11kV, 1-core x 1000 sq mm AL
- 11kV, 1-core x 150 sq mm AL HTAB
- 11kV, 1-core x 15 sq mm AL HTAB
- 33kV, 3-core x 300 / 400 sq mm AL
- 66kV, 1-core x 630 sq mm AL
- 66kV, 1 core x 1000 sq mm AL
- 66kV, 3-core x 300 sq mm AL

3.1.0	Conductor	a) Electrolytic Grade Stranded Aluminium Conductor b) Grade: H2 / H4 as per IS: 8130 / 1984 (For Al) c) Stranded, compacted and circular in shape d) Class 2 e) Longitudinal "Water-Blocking Arrangement" (or water-tight construction or water barrier protection)
3.1.1	Conductor Screen	Extruded Semi Conducting material
3.1.2	Insulation	Extruded XLPE Insulation for 11 kV and Extruded TR-XLPE Insulation for 33 kV and 66 kV
3.1.3	Insulation Screen	Freely strippable Semi Conducting (without application of heat) for 66kV firmly bonded.
3.1.4	Water Swell able Tape	Semi-conducting Water Swell able Tape under the copper tape on each core.
3.1.5	Copper Tape	Copper Tape applied helically over the layer formed by application of insulation screen, water swell able tape and identification strip
3.1.6	Filler	All interstices, including center interstices filled by PP filler.48 no OFC (36 single mode and 12 no multi mode) as a filler in 66 kV, 3CX300 sqmm cable only.
3.1.7	Over all three cores	Binder tape
3.1.8	Inner Sheath	Extruded Inner Sheath of Black PVC type ST-2.
3.1.9	Armour	a) For 11 kV 3-core Cables : Galvanized Steel flat strip armour b) For 1-core Cables : Non-Magnetic, Hard drawn Aluminium wire (flat/round) c) Corrugated aluminium or lead sheathed for 1core 66kV Cable 6) For 66 kV 3-core cable- Round wire AL.
3.1.10	Binder Tape	Rubberized cotton tape
3.1.11	Outer Sheath	Extruded outer sheath of PVC (ST-2) for 11 kV and 33 kV and HDPE ST 7 for 66kV with termite- repellent and anti-rodent properties. For 66kV , 3Cx300 extra extruded semicon/graphait layer over HDPE ST7.

**Technical Specification For Heat Shrinkable And Cold Shrinkable Straight Through Jointing Kit (11 kV, 33 kV, 66 kV XLPE Insulated Cables)**

3.1.12	HTAB Cable (1CX150 and 1CX95)	AB cable- conductor-conductor semicon screen- TR XPLE-insulation sc Water Swallowable tape -Round wire armour (in the place of copper tap Water Swallowable tape-outer sheath+massenger wire
3.1.13	OFC	For 66kV, 3CX300 Cable- Single Mode-36 Nos. Multi Mode- 12 nos. All the OFC cable is placed as filler inside the cable.

#### 4.0.0 Straight-Through Joints (STJ)

General Technical Requirements for Straight-Through Joints (STJ) for XLPE cables are as follows:

**Scope:** Design, manufacture, testing and supply of Straight-Through Joint Kits for 11 kV, 33 kV & 66kV Power Cables.

Functional requirements for Heat Shrinkable / Cold Shrinkable STJ joints are given below:

4.1.0 Heat Shrinkable / Cold Shrinkable STJ joints		
4.1.1	Cable preparation	Cable preparation shall be as per installation instruction sheet. Manufacturer shall be provide Installation instruction sheet in every kit
Connector		
4.1.2	Conductor Screen	For 11kV a) Conductors to be jointed by crimping connectors b) Annular CSA (cross-sectional area) of the ferrule shall not be less than CSA of the conductor of the cable. Length of the ferrule shall be sufficient to allow adequate number of crimps, to limit temperature rise at the joint. (Vendor to furnish dimensional drawing for ferrule, indicating crimp marks.) c) For aluminium cable, the crimped ferrule shall be of aluminium d) Refer annexure F for GA drawing of crimping ferrule  For 33kV and 66kV a) Shear bolt type mechanical connector b) Approved make: • Tyco Electronics ( BSM-185/400-U) • Pfisterer ( 332617010) • Or equivalent make (Manufacturer shall take prior approval from CES) d) Maintain smooth surface over connector after cut the shear head bolt e) Vendor to furnish drawing for the mechanical connector

**Technical Specification For Heat Shrinkable And Cold Shrinkable Straight Through Jointing Kit (11 kV, 33 kV, 66 kV XLPE Insulated Cables)**

4.1.3	Void filling and stress relief over crimped connector and cut point of the insulation screen.	By means of High permittivity mastic tapes / Lubricant.
4.1.4	Metal screen continuity	By means of Tinned copper wire mesh, wrap individual core from cu screen with 50 % overlap and continue on other side cu screen. Bind the copper wire mesh on copper screen with copper binding wire
<b>Armour / Earthing Continuity</b>		
4.1.5	Armour bond	a) By means of a combination of steel (G.I.) support ring (for 3 - core Cable) or Aluminium support ring (for 1 - core Cable) and two nos. of stainless steel hose clips. b) GI Support Ring shall be 'zinc-sprayed with central bulge / bump'.
4.1.6	Armour continuity	By means of two nos. Of tinned copper braided conductor of 25 sq. mm. for 11 kV 35 sq. mm. for 22 or 33kV and 50 sq mm for 66kV.
4.1.6	OFC	For 66KV, 3CX300 Cable- Single Mode-36 Nos. Multi Mode- 12 nos OFC Cable shall be jointed separately. OFC joint shall not place inside main cable joint.
<b>Accessories</b>		
4.1.7	Suppression of electrical discharges over XLPE insulation	Cleaning solvent /equivalent, for manual application.
4.1.8	Installation Instruction	Shall be provided in English and Hindi and shall be inside every kit.
4.1.9	Sheet paper Tap	Paper tape, required for measurements during jointing, shall be provided inside every kit.

**Technical Specification For Heat Shrinkable And Cold Shrinkable Straight Through Jointing Kit (11 kV, 33 kV, 66 kV XLPE Insulated Cables)**

4.1.10	Identification Tag (for traceability)	<p>a) An aluminum pouch with paper tag &amp; sealing arrangement at one end shall be provided.</p> <p>b) This tag is required to be tied over the cable at one side of the joint.</p> <p>c) The paper tag shall give following information</p> <ol style="list-style-type: none"> <li>1) Vendor kit designation</li> <li>2) Cable section/Division</li> <li>3) Type of joint</li> <li>4) Size of Joint</li> <li>5) Make of joint</li> <li>6) Voltage class</li> <li>7) Serial no. of kit</li> <li>8) Vendor lot &amp; batch no</li> <li>9) Month &amp; year of manufacturing</li> <li>10) Date of installation</li> <li>11) Name of jointer</li> <li>12) Name of vendor supervisor</li> <li>13) Name of BSES supervisor</li> <li>14) Remarks</li> </ol>
4.1.11	Printing on each Heat/cold shrinkable or Moulded component	Month and year of manufacturing, batch no. /lot no., size, make, type etc.
4.1.12	GPS Coordination	Vendor to capture GPS coordinates and shall include in job card of each joint at their own cost.
4.1.13	Hydraulic Crimping	Using of Hydraulic crimping tool is mandatory for crimping purpose
4.1.14	Coffin for completed joint and Joint Marker	<p>After successfully completion of joint, Coffin shall be made by bidder for completed joint. Drawing shall be provided by BSES. Excluding drawing, everything shall be in the scope of bidder.</p> <p>After back filling a joint marker shall be fixed by bidder above ground to mark the joint location. Drawing is enclosed with this tech spec.</p>
4.1.15	Electronic Ball Marker for 33kV and 66kV Cable Joint.	Passive and Active ball shall be supplied and placed at each and every joint to mark the joint electronically. Data shall be filled by bidder as per BSES requirement.
4.1.16	OFC	66KV, 3CX300 sqmm cable Joint for OFC shall be supplied along with main cable joint. (36 single mode and 12 nos multi mode OFC inbuilt inside cable). OFC joint shall be made separately from main cable joint.

**4.2.0 Only for Heat Shrinkable STJ joints**



**Technical Specification For Heat Shrinkable And Cold Shrinkable Straight Through Jointing Kit (11 kV, 33 kV, 66 kV XLPE Insulated Cables)**

4.2.1	Stress Control System	<p>a) The earthed insulation screen of an XLPE cable is terminated at a suitable distance from the connector (Ferrule).</p> <p>b) The stress control tube is in electrical contact with insulation screen.</p> <p>c) Impedance of the tube shall be constant up to an operating temperature and shall be within the range <math>1 \times 10^8</math> ohm-cm to <math>8 \times 10^8</math> ohm-cm.</p> <p>d) The physical and electrical properties shall conform to EA TS 09-13.</p>
4.2.1	Insulation build-up	<p>a) Maximum three layers of insulation tubes shall be used. Total thickness of the insulation being provided in the joint shall not be less than 1.2 times the insulation of the cable being jointed.</p> <p>b) Outer-most tube shall be screened insulating tube (dual wall tube). This tube shall be manufactured by extrusion process.</p> <p>c) Physical and Electrical properties shall conform to EA TS 09-13.</p>
4.2.2	Sealing end of tube	By means of Core end sealing sleeve with red mastic coating
4.2.3	Mechanical Protection	<p>a) For 3-core cable: By means of a rollable steel mat (with required protective coating against corrosion)</p> <p>b) For 1-core cable:</p> <ul style="list-style-type: none"> <li>i) Copper wire mesh</li> <li>ii) Adhesive coated medium wall tube</li> <li>iii) One more layer of copper wire mesh</li> <li>iv) Medium wall tube</li> </ul>
4.2.4	Corrosion Protection	By means of semi-rigid tubes, internally coated with water blocking sealant. Thick wall Insulating tube

**4.3.0 Only for Cold Shrinkable ST joints**

**Scope:**

The term cold shrink applies to materials, which are capable of shrinking without raising the material above the ambient temperature of its immediate surroundings. The material of the rubber insulator used in the Cold Shrink assembly shall be silicone which is factory expanded and placed on a removable core. The removing of the core causes the cold shrink assembly to shrink. The cold shrink assembly shall maintain a compressive force on the cable continuously throughout the life of the product. This pressure will ensure a complete moisture seal.

4.3.1	Stress Control System	By means of one piece body (splice assembly) providing stress control, insulation and screen continuity.
4.3.2	Mechanical Protection	By application of mastic coated vinyl tape and armor cast structural material. The taped armor cast layer may also be sprayed with water to hasten the curing.

**Technical Specification For Heat Shrinkable And Cold Shrinkable Straight Through Jointing Kit (11 kV, 33 kV, 66 kV XLPE Insulated Cables)**

4.4.0	Technical Particulars	Vendor shall submit Guaranteed Technical Particulars (GTP) as per Annexure A.
4.5.0 Testing & Inspection		
4.5.1	Type Tests (CPRI/ERDA)	<p>a) Straight-Through Joint shall be of type-tested quality from CPRI/ERDA.</p> <p>b) In addition to this, in case of rate contact, vendor will be required to conduct type-testing on heat/cold -shrinkable and moulded components, stress grading mastic, etc., in line with EA TS 09-13 standard, at third party test laboratory once in 6 months on randomly selected sample of each voltage rating without any commercial implication to BSES. Also special test shall be done as per IS 13573.2.2011, Table-7 without any cost implication to BSES. Cable for type test may be provided by buyer at the cost of bidders.</p> <p>C) If product is not type tested or test report is more than 5 years old from CPRI/ERDA, same shall be carried out by seller, sample shall be selected randomly by BSES, test cost to be borne by seller. For new vendor, type test is mandatory from CPRI/ERDA of BSES sample at their own cost. All the cost of inspector shall be borne by seller as mentioned in inspection expenses clause</p>
4.5.2	Routine & acceptance Tests	<p>I) All the routine and acceptance tests shall be carried out as per EA TS 09-13 guidelines, refer Annexure C.</p> <p>II) H.V. Test shall be carried out on a randomly selected and installed Straight-Through Joint, in the presence of Purchaser's representative, at manufacturer's works.</p> <p>III) The joint shall withstand a test of 4Uo voltage for 4 hours.</p>
4.5.6	Inspection	<p>I) Purchaser reserves the right to inspect /witness all tests on the STJ Kits at Seller's works at any time, prior to dispatch, to verify compliance with the specification.</p> <p>II) In-process and / or final inspection call intimation shall be given in advance to purchaser.</p>
4.5.7	Test Certificates	<p>i) Three sets of complete Test Certificates (Routine &amp; Acceptance tests) shall be submitted along with the delivery of STJ Kits.</p> <p>ii) Bought-out Items: Vendor shall submit Test Certificates, lot/batch number-wise, from their sub- suppliers / principal. TC's should clearly indicate the measured technical parameters, in accordance with sub-supplier's specification. (Also refer Annexure - C)</p>
4.6.0	Documents	"Documents" refer to Documents, Data, Manuals, etc. (Scanned copy of signed documents also shall be part of entire soft file (e-file) or CD.

**Technical Specification For Heat Shrinkable And Cold Shrinkable Straight Through Jointing Kit (11 kV, 33 kV, 66 kV XLPE Insulated Cables)**

4.7.0	Along with the Bid	Vendor shall submit signed 3 sets (plus 1 set of soft copy) of following documents a) GTP (duly filled-in) (as per Annexure — A) b) Cross-sectional drawings for components Assembly. c) Type Test Certificates d) Complete Catalogue and Installation Instructions. e) Any other document.
4.8.0	After Award Contract	Vendor shall submit signed 2 sets (plus 1 set of soft copy) of above-mentioned documents within 15 days, for Purchaser's approval.
4.8.0	"As-Built" documents	Final signed "As-built" documents for the equipment in 3 sets (hard copy), 1 no. soft copy and 1 no. CD. These documents shall include signed Routine & Acceptance Test Certificates also.
4.9.0	Packing, Marking, Shipping, Handling and Storage	a). Every component / kit / box shall be properly sealed/ packed for protection against damage. Stress grading mastic shall be packed in air-tight / air-sealed packing. b). Every kit box shall be wrapped in polythene covers. c). Separate packing (sub-kits) shall be provided, for components (given below) used in crotch area and connector area. These sub-kits, labeled as "CROTCH KIT" and "CONNECTOR KIT", shall be placed inside every kit box. i) Crotch Kit Components --Conductive cable break-out -- Yellow moulded wedge -- Break-out end sealing tube -- Break-out finger sealing tube -- Stress grading mastic ii) Connector Kit : Components -- Ferrule (connector) -- Void Filling mastic (yellow)

**Technical Specification For Heat Shrinkable And Cold Shrinkable Straight Through Jointing Kit (11 kV, 33 kV, 66 kV XLPE Insulated Cables)**

4.9.1	Identification Label	<p>Markings / Labels shall be on both sides of every packed box.</p> <ol style="list-style-type: none"> <li>1) Identification number/type designation (as per manufacturer's standard)</li> <li>2) Voltage grade, size, description of the Kit (including the voltage grade, size, type of the cables, for which it is to be used)</li> <li>3) Batch no., lot no., etc.</li> <li>4) Quantity</li> <li>5) a) Purchase Order no. &amp; date b) Purchaser's name c) BSES's SAP code number</li> <li>6) Weights (kg) of each Cable Termination Kit and of each box containing kits.</li> <li>7) Manufacturer's name</li> <li>8) Month &amp; Year of Manufacturing</li> <li>9) Date of packing, shelf life (if applicable)</li> </ol>
4.9.2	Transit damage	The seller shall be responsible for any transit damage due to improper packing.

**5.0.0 Quality Assurance Plan (QAP)**

5.1.0	Vendor's Quality Assurance Plan (QAP)	To be submitted for Purchaser's approval.
5.2.0	Sampling Method	Sampling Method for quality checks shall be as per manufacturer's standard practice / ESI guidelines and Purchaser's prior approval shall be taken for the same.
5.3.0	Inspection Hold-Points	To be mutually identified, agreed and approved in Quality Plan.

**6.0.0 Deviations**

6.1.0	Deviations	<ol style="list-style-type: none"> <li>a) Deviations from this specification shall be listed by bidder clause wise along with optional offer and has to submit the list along with bid./quotation. BSES will review the deviations and if BSES is agreed with the deviation, seller has to take written confirmation from BSES on deviation during tender evaluation..</li> <li>b) In the absence of any list of deviations from the Seller with bid as well as written confirmation from BSES on deviations, it will be assumed by the Buyer that the Seller complies with the Specification fully.</li> <li>c) Any deviations mentioned in any other submitted bid documents (i.e.in filled GTP, Catalog, BSES old approval, buyer's/seller's standards etc) by seller without separate deviation sheets will not be considered as a deviation from this tech spec at any stage of contract.</li> </ol>
-------	------------	---

**Technical Specification For Heat Shrinkable And Cold Shrinkable Straight Through Jointing Kit (11 kV, 33 kV, 66 kV XLPE Insulated Cables)****7.0.0 Delivery**

7.1.0	Delivery	Dispatch of Material: Vendor shall dispatch the material, only after the Routine Tests /Final Acceptance Tests (FAT) of the material witnessed/waived by the Purchaser, and after receiving written Material Dispatch Clearance Certificate (MDCC) from the Purchaser.
-------	----------	---

**8.0.0 Inspection Expenses**

Inspection (i.e. routing test, acceptance test, type test, factory visit etc.) shall be done any time by BSES on the basis of PO or may involve 3<sup>rd</sup> party as per BSES requirement. Inspection expenses like accommodation, fooding, local transport, air fair, train fair, taxi (NCR) etc shall be borne by seller.

Any kind of test (routine/type test/acceptance test if any) at 3<sup>rd</sup> lab (i.e. CPRI/ERDA/NABL approved lab) shall be carried out by seller at their own cost. BSES may witness the test and the expenses like accommodation, fooding, local transport, air fair, train, taxi etc. shall be borne by seller.

Above expenses shall be applied at each and every inspection and shall stand till closing of PO/WO/Rate contracts etc.

**9.0.0 Failure Analysis and Penalty**

Failure of joint shall be analyzed by BSES and Vendor jointly. Joint failure in regards to poor quality joint, poor work man ship, etc. shall be in the account of vendors. Losses due to failure shall be recovered from vendor in case of warranty.

**Technical Specification For Heat Shrinkable And Cold Shrinkable Straight Through Jointing Kit (11 kV, 33 kV, 66 kV XLPE Insulated Cables)****Annexure - A: Guaranteed Technical Particulars (GTP)**

The Vendor is deemed to have examined all parts of the Specification documents and to have been fully informed, as to the nature of work and the conditions related to its performance.

<b>S No.</b>	<b>Description</b>	<b>Purchase requirement</b>	<b>Vendor's data</b>
1	Manufacturer's name		
2	Purchase Order no. & date		
3	Guarantee Period (minimum)	60 Months (from date of commissioning) / 66 Months (from date of receipt at Purchaser's store), whichever is earlier	
4	Applicable IS / IEC Standard followed by Vendor (incl. type test standard)		
5	Voltage Grade (kV)		
5.1	Lightning Impulse Voltage Withstand Test		
5.2	4Uo AC voltage withstand test for 4 hours	To be conducted on Installed joint at works	
6	Continuous operating temperature	90 deg. C	
7	Functional Requirements		
7.1	Method of Stress Control and Discharge Suppression		
7.2	Method of Insulation build-up and screening		
7.3	Method of earth bond a) Size and no. of braids b) Size of armour support c) No. of hose clips		
7.4	Method of mechanical protection a) for 3-core Cable b) for 1-core Cable		
7.5	Method of protection against corrosion (type & coating thickness of protective layer on steel mat)		
7.6	Method of conductor continuity a) For crimping connector b) For mechanical connector		

**Technical Specification For Heat Shrinkable And Cold Shrinkable Straight Through Jointing Kit (11 kV, 33 kV, 66 kV XLPE Insulated Cables)**

8	Description of items in the Kit, which are imported /sourced From Principal /Sub-suppliers		
9	Names of items in the Kit and their respective shelf life (months   years)		
10	Kit Content Table (KCT) enclosed? (Refer Annexure — B)	Yes / No	
11	Drawing for connector (ferrule) enclosed	Yes / No (If yes, mention the document reference)	
12	Is Annexure - D (Technical Deviation Sheet) duly filled-in?		
13	Packing (Qty) i) Packing of every Kit h) Group Packing	1 no -- No. of Kits per Box -- No. of Boxes	
14	Installation Procedure enclosed?	Yes / No (If yes, mention the document reference)	
15	Quality Assurance Programme (QAP for raw materials, in-process inspection, factory testing) is enclosed?	Yes / No	
16	Whether all heat-shrinkable and moulded components of the kit meet the requirements of and have been tested in accordance with EA TS -09-1 3.(for heat-shrinkable joints)	Yes / No (If yes, details of test report no. /Date /name of test laboratory to be mentioned.)	
17	Type Test Reports (TTR) (Relevant test report no. & date, With type, size, other details of each type of Kit.) a) Prepared Joint: CPRI TTR as per BIS / IEC enclosed? b) Loose Components: CPRI TTR as per EA TS 09-13 enclosed?	Yes/No Yes/No	
18	Printing details on each of the Heat- shrinkable and Moulded components	(Mention the text, presently printed on each of the component)	



SP-HCSTJ-03-R2

**Technical Specification For Heat Shrinkable And Cold Shrinkable Straight Through Jointing Kit (11 kV, 33 kV, 66 kV XLPE Insulated Cables)**

19	OFC kit (66kV, 3CX300 sqmm cable)	Yes/no	
----	-----------------------------------	--------	--

**Annexure - B: Kit Content Table (KCT)**

Vendor shall submit KCT as a consolidated table, consisting of all data, such as:

**A. Heading**

1. Voltage grade, size, description of the Kit  
(Including the voltage grade, size, type of the cables, for which it is to be used)
2. Type designation (as per manufacturer's standard)

**B. Details / Parameters (For each component/item of the KCT)**

1. Lot no. /Batch no., etc.
2. Item number (manufacturer's standard)
3. Description
  - a) Material, type, make and grade
  - b) Dimensions cross sectional area
  - c) Colour,
  - d) Other description, if any
4. Function of the item
5. Quantity
6. Make/Name/Location of manufacturer/sub-vendor
  - a) Minimum supplied (or in expanded form) diameter
  - b) Maximum freely recovered diameter
7.
  - a) Minimum supplied (or in expanded form) thickness
  - b) Maximum freely recovered thickness

**C. Notes on the KCT**

Markings, printings and other details for individual/group of components is to be mentioned on KCT. For example:

- a) Printing of item code, size, batch no., etc.
- b) Printing on components
- c) Other embossing or engraving, if any.

(Note: Vendor may attach an Annexure, for any additional information, if required.)



**Technical Specification For Heat Shrinkable And Cold Shrinkable Straight Through Jointing Kit (11 kV, 33 kV, 66 kV XLPE Insulated Cables)****Annexure - C: Routine and Acceptance Test****A. Visual Examination**

Condition of selected items / components, as per sampling method, shall be recorded. Some of the normal check-points can be as follows:

1. Every component shall be verified in quantity and description as per KCT.
2. All items shall be free from any defects, pin holes, cracks, etc.
3. Metallic components to be free from sharp edges.

**B. Measurements of Dimensions**

(Required / observed dimension — length, diameter, etc.)

1. Supplied dimensions
2. Recovered dimensions

**C. Destructive Testing**

On various heat-shrinkable / moulded components of ready Kits (items 3 and 4 are applicable only for heat-shrinkable components)

1. Tensile Strength
2. Wall Thickness Ratio
3. Heat Shock
4. Longitudinal Change, after full recovery
5. Ultimate Elongation
6. Low Temperature Flexibility
7. Dielectric Strength
8. Volume Resistivity

**Routine Test Reports (RTR) (Typical)**

Each RTR shall clearly indicate P.O. no. & date and also BSES's SAP code no. RTR shall record the serial numbers of the kits selected, as per vendor's sampling method. Following details, besides vendor's/manufacturers standard check-points, shall appear in every RTR.



SP-HCSTJ-03-R2

**Technical Specification For Heat Shrinkable And Cold Shrinkable Straight Through Jointing Kit (11 kV, 33 kV, 66 kV XLPE Insulated Cables)**

**Annexure - D: Deviation Sheet**

Sr No.	Clause No.	Deviation

**Annexure - E: Service Conditions**

(Atmospheric conditions in Delhi)

a)	Average grade Soil Condition	
b)	Maximum altitude above sea level	1000 M
c)	Ambient Air temperature	Highest 50 Deg C, Average 40 Deg C
d)	Minimum ambient air temperature	0 Deg C
e)	Relative Humidity	100 % Max
f)	Thermal Resistivity of Soil	150 Deg C cm/W
g)	Seismic Zone	4
h)	Rainfall	750 mm concentrated in four months

## Technical Specification For Heat Shrinkable And Cold Shrinkable Straight Through Jointing Kit (11 kV, 33 kV, 66 kV XLPE Insulated Cables)

### Annexure - F: Aluminium crimping-type Ferrule for compacted circular conductor only for Heat Shrink joints

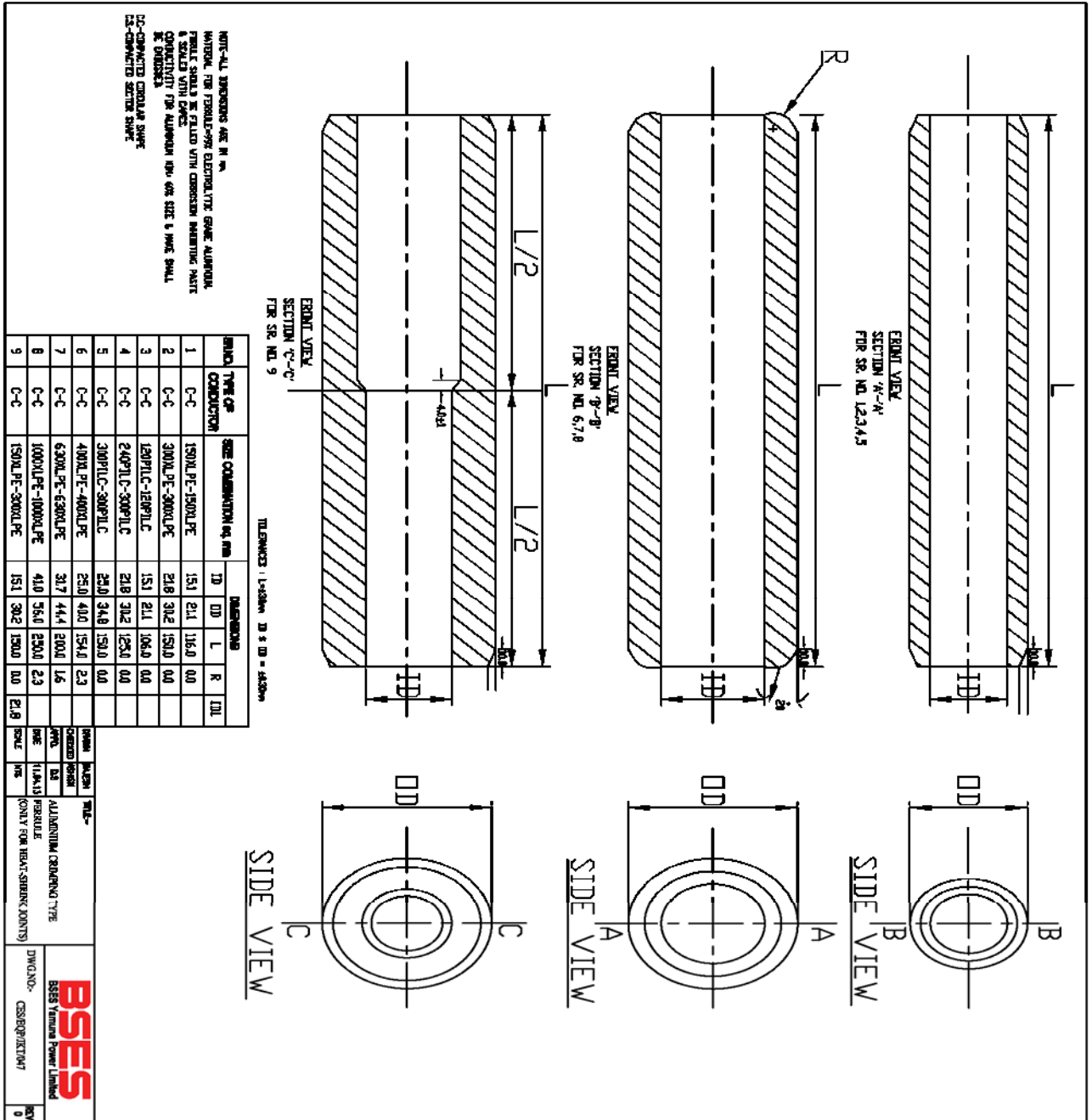

## Technical Specification For Heat Shrinkable And Cold Shrinkable Straight Through Jointing Kit (11 kV, 33 kV, 66 kV XLPE Insulated Cables)

### Annexure – G: Strip type GI canister (V.B. Can) for joint protection only for Heat Shrink Joint

**SIDE-B**

**SIDE-B**

**NOTE-ALL DIMENSIONS ARE IN mm**

**SIZE-A-WHICH IS WITH TWO SMALL ALUMINUM FOIL STRIPS IT SHOULD BE INSTALLED UPWARDS**

**SIZE-B-WITH ALMOST COMPLETE ALUMINUM FOIL, IT SHALL BE INSTALLED OVER THE JOINT.**

**DI MATERIAL-STEEL STRIPS**  
**THICKNESS 1mm-4.5mm**  
**VOLTAI DENT 400mm**  
**CORROSION-RESISTANT ANTI-CORROSSIVE**  
**OR ANTI-RUSTING STEEL STRIPS-5mm MINIMUM 6 DENT MAXIMUM**  
**DI ADHESIVE TAPE-3 PLY LAMINATE RESINULE ALUMINUM FOIL WITH POLYESTER FILM**

**DIMENSIONS FOR STRIP TYPE GI CANISTER**

GRADA	VOLTAGE	JOINT SIZE	NO. OF STRIPS	LENGTH(L)	WIDTH (W)
1	11KV	120PILC-120PILC	40	1450	460
2	11KV	240PILC-240PILC	46	1950	460
3	11KV	120PILC-150XLPE	40	1450	400
4	11KV	240PILC-300XLPE	46	1950	460
5	11KV	120PILC-300XLPE	46	1950	460
6	11KV	70PILC-300XLPE	46	1350	460
7	11KV	150XLPE-150XLPE	34	1260	340
8	11KV	300XLPE-300XLPE	36	1360	360
9	11KV	150XLPE-300XLPE	36	1360	360
10	33KV	300PILC-300PILC	50	1850	500
11	33KV	300PILC-400PILC	50	1850	500

REVISION	DATE	TITLE
CHECKED	12/3	STRIP TYPE GI CANISTER (V.B. CAN) FOR JOINT PROTECTION (GENERAL ARRANGEMENT)
DATE	11/04/13	
SCALE	1/1	

**BSES** BSES Transmission Power Limited

DWG. NO. - **CS3/SP/JKT/048**

REV. **0**

## Job Card For Cable Jointing Work

Job Card No  Date  Fault ID

Division  Purpose  Project / Scheme  O&M

Contractor

Voltage Grade  11kv  33kv  66kv  1.1 KV/LT

No. of cores  1  3  3.5/4

Cable Size: 1000 / 800 / 630 / 500 / 400 / 300 / 240 / 225 / 185 / 120 / 95 / 70 / 50/25 sqmm

Jointing Details	Type of Joints	No. of Joints		Docate No.	IR Ref.
		Single	Double		
	XLPE/XLPE(or PVC/PVC) Straight Through Joints				
	XLPE/PILCA Transition Joint				
	PILCA/PILCA Straight Through Joints				
	XLPE Indoor Termination				
	XLPE Outdoor Termination				
	PILC Indoor Termination				
	PILC Outdoor Termination				

Feeder Details From  To

Location From  To

Landmark: \_\_\_\_\_

Fault Occurance Date: \_\_\_\_\_

Job Allocated By: \_\_\_\_\_ PWT Ref: \_\_\_\_\_

Date and Time of Spiking  Date  Time  Work Completed On:  Date  Time

Digging Details (In Meter) Length  Wedth  Depth

Details of cable laid Size  Length (In Meter)  Docate Ref.:

Contractor Supervisor : \_\_\_\_\_ Signature : \_\_\_\_\_ Date : \_\_\_\_\_

Jointer Details: \_\_\_\_\_

Stage Verification	Stage/Work Verification	Name & Signature	Date & Time
ie : Digging / Jointing etc.			

Scrap Details including Qty: \_\_\_\_\_

New Kit Details: \_\_\_\_\_

Old Kit Details: \_\_\_\_\_

Type of Fault: \_\_\_\_\_

Remark If any : \_\_\_\_\_

Job Certified By :

Shift Incharge Name Signature Date

1\* COPY - BILLING COPY

## Annexure-I

<b>SOP FOR REPAIRING OF CABLE FAULT (Shall be part of PO)</b>		
Sl. No.	Activity	Responsibility
<b>Initiation</b>		
1	Identify and isolate fault and inform GNIIT in case of cable fault	Break down team
2	Updation of the details in OMS against respective feeder tripping event.	GNIIT
<b>Fault Location</b>		
1	Information sent to FLC team and SDO.	GNIIT
2	Mobilize FLC team and cable jointing contractor.	SDO
3	Identification of fault location	FLC Team
<b>Preparation for Jointing</b>		
1	Seeking permission from road owning agency	SDO
2	Payment of RR charges to Road owning agency	Finance
3	Digging	Cable jointing contractor
4	Cut faulty section and Pre-test (HV test) cable for multiple fault	Cable jointing contractor
5	BOQ estimation for jointing work ( type, size and length of cable, type of jointing kit)	Cable jointing contractor
6	Filling material reservation slip ( MRS) in SAP	SDO
7	Issuing and transporting material from store.	Cable jointing contractor
<b>Jointing</b>		
1	Cable preparation ( overlap length of cable, slide of armour, build up with inner sheath etc)	Cable jointing contractor (for jointing details refer to manufacturer instruction manual)
2	Copper tape shields	
3	Core preparation	
4	Location of parts in completed joints	
5	Earthing of connection	
6	Completion of joints	
7	Take Photographs before, during and after jointing and send to CES	SDO
8	Supervision during jointing	SDO
9	Sending failed joint to Division store	Cable jointing contractor
<b>Completion and reporting</b>		
1	Intimate to breakdown team about joint completion.	Cable jointing contractor
2	Conduct HV test	Break down team
3	Restore of Supply through jointed cable	Break down team
4	Backfilling and compaction of excavated soil	Cable jointing contractor
5	Completion information in Job Card (Details	Cable jointing contractor

Annexure-I

	of work done, material consumption, location, feeder name and joint tag no., date, supervisor name, jointer name) sent to SDO	
6	Above information sent to GNIIT	SDO
7	Send information about GPS location of Cable fault to GIS	SDO
8	daily report of cable jointing to CES	Division Head
9	Updation of information in OMS including supervisor name, jointer name, feeder name	GNIIT
10	Information to include GPS location of cable fault.	GNIIT

Special Note-

- 1) Joints to be done preferably during day. In case of constraints, DGM (O&M) to authorize for night time jointing with supervisor
- 2) Daily joint report to be shared with CES
- 3) Bi-monthly analysis of faulty joint for ensuring warranty compliance to be organized at circle level by contractor in presence of DGM (O&M) and CES
- 4) Certification of job card for payment by DGM (O&M) subject to OMS compliance CES to check any gaps.

# ANNEXURE- J-DETAIL OF CABEL JOINT MARKER (RCC) -BSES

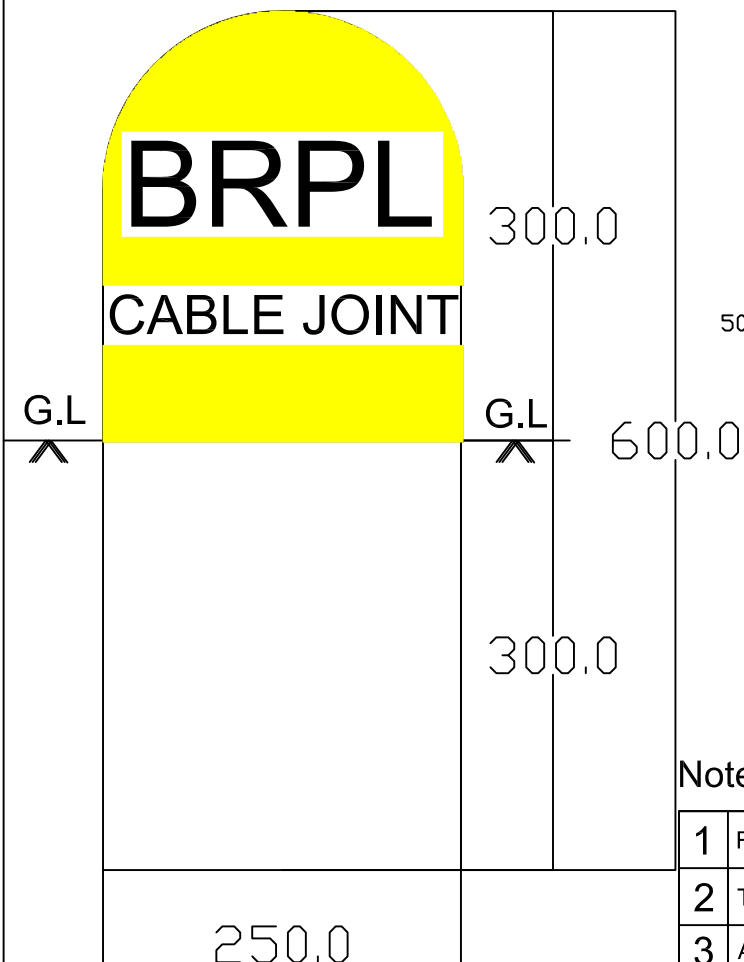

## Reinforcement Detail

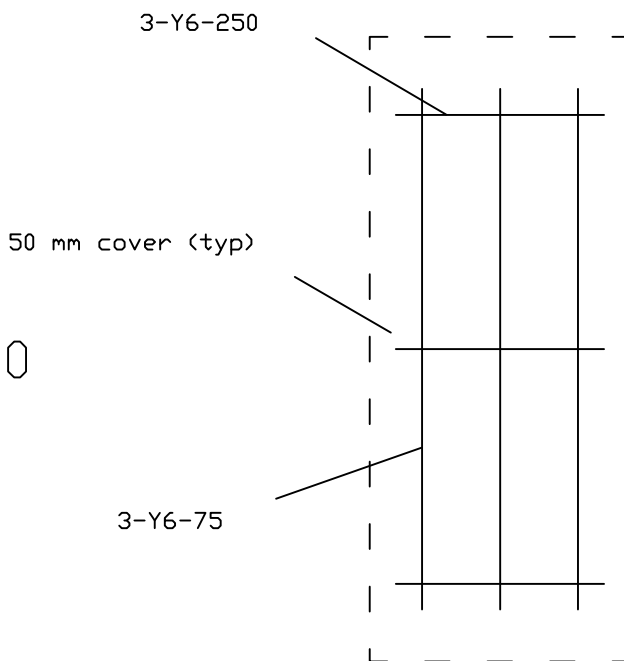

### Notes:-

1	RCC Cable Joint marker with 6 mm Dia. Rod and M25 concrete grade.
2	The letter/word shall be engraved on both the side route marker.
3	All dimintions are in mm unless specified.
4	Thickness of RCC shall be 75mm.
5	Yellow colour shall be visible above ground level above ground.
6	Each Cable Joint marker to be placed at each joint location
7	All kind of paint on route marker shall be in the scope of manufacturer.



DRAWN	R.K.JANA	TITLE:- DETAIL OF CABLE JOINT MAKER (RCC).	BSES Rajdhani Power Ltd. DWG. NO. BSES-JM-RCC-01, R0
CHECKED	P.B		
REVIEWED	A.T		
APPO.	V.P.		
DATE	25-04-2017		



# BSES

## Technical Specification For LT Cable Joints

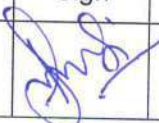
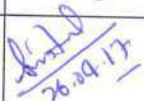
Specification no – SP-LTJKT-06-R2

Prepared by		Reviewed by		Approved by		Rev	Date
Name	Sign	Name	Sign	Name	Sign		
Pronab Bairagi		Amit Tomar	 26/04/17	Vijay Panpalia	 26/4/17	R2	26/04/2017

**Technical Specification For Heat Shrinkable And Cold Shrinkable Straight Through Jointing Kit (1.1kV XLPE Insulated Cables)****Index**

Record of Revision.....	3
1.0.0 Scope of supply.....	4
2.0.0 Codes & standards.....	4
3.0.0 Jointing Type and size .....	4
4.0.0 Heat Shrinkable Joints .....	5
5.0.0 Polyurethane Compound .....	6
6.0.0 Mould .....	7
7.0.0 Connector Insulation .....	7
8.0.0 Aluminium Braid .....	8
9.0.0 Aluminium Ferrule .....	8
10.0.0 Inspection & Testing.....	8
11.0.0 Container Printing .....	9
11.0 Packing and Delivery .....	10
12.0 Deviations .....	10
13.0 Inspection Expenses .....	10
14.0 Failure Analysis and Penalty.....	10
Annexure A - Bill of Material (BOM) for JNT KIT .....	11
Annexure A.1 - Bill of Material (BOM) for JNT KIT N-HS STRT 1.1KV 300MM2 MOULD S6 .....	11
Annexure A.2 - Bill of Material (BOM) for JNT KIT N-HS TRANSN 1.1KV 240/300 MLD S6 .....	12
Annexure A.3 - Bill of Material (BOM) for JNT KIT N-HS STRT 1.1KV 150MM2 MOULD S5 .....	13
Annexure A.4 - Bill of Material (BOM) for JNT KIT N-HS TRANSN 1.1KV 120/150 MLD S5 .....	14
Annexure A.5 - Bill of Material (BOM) for JNT KIT N-HS STRT 1.1KV 50MM2 MOULD S4 .....	15
Annexure A.6 - Bill of Material (BOM) for JNT KIT N-HS STRT 1.1KV 25MM2 MOULD S3 .....	16
Annexure B: Drawing of Mould for Joint .....	<u>18</u>
Annexure C: Drawing of Al Crimping Ferrule.....	<u>19</u>
Annexure D: Drawing of Worm Drive Clip.....	<u>20</u>
Annexure E: Drawing of Solid Collet.....	21
Annexure F: Job Card .....	22
Annexure G: SOP .....	<u>23</u>



**Technical Specification For Heat Shrinkable And Cold Shrinkable Straight Through Jointing Kit (1.1kV XLPE Insulated Cables)****1.0.0 Scope of supply**

Design, manufacture, testing of LT jointing kits (1.1kV) at manufacturers works before dispatch, packing, delivery of material and submission of documents to purchaser.

**2.0.0 Codes & standards**

S No.	Title	Indian Standard
2.1	Cable accessories for extruded power cable	IS 13573 (Part 1):2011
2.2	Epoxy resin system for Cast resin insulated cable jointing up to and including 11Kv	IS:10333:1982
2.2	Ferrule	IS:8308, IS:5082
2.3	Mould	IS 8438-1987

**3.0.0 Jointing Type and size**

3.1	Jointing Type	Polyurethane Cable Jointing / Heat Shrinkable Cable Jointing
3.2	Kit Size	S3- 4C 25 sq mm (STRT) S4- 4C 50 sq mm (STRT) S5- 3.5C/4C 150 sq mm (STRT) S5- 3.5C/4C 120-150 sq mm (TRJ) S6- 3.5C/4C 300 sq mm (STRT) S6- 3.5C/4C 240-300 sq mm (TRJ)
3.3	Rating Of Cable	1.1 KV
3.4	Rated frequency	50 HZ
3.5	Maximum Conductor Temperature	Continuous- 90 deg C, Short circuit- 250 Deg C
3.6	Cable Laying Conditions	Depth of Trench: 0.75 Meter Ground Temperature: 25 deg C Thermal resistivity of soil: 150 ° C cm/ W Average Ambient Temperature: 35 ° C
3.7	Kit Contents	As detailed in Bill of Material ( BOM)
3.8	GPS Coordination	Vendor to capture GPS coordinates and shall include in job card of each joint at their own cost
3.9	Hydraulic Crimping	Using of Hydraulic crimping tool is mandatory for crimping purpose
3.10	Coffin for completed joint	After successfully completion of joint, Coffin shall be made by bidder for completed joint. Drawing shall be provided by BSES. Excluding drawing, everything shall be in the scope of bidder.

**Technical Specification For Heat Shrinkable And Cold Shrinkable Straight Through Jointing Kit (1.1kV XLPE Insulated Cables)**

**4.0.0 Heat Shrinkable Joints**

4.1	Minimum Requirement	<ol style="list-style-type: none"> <li>1. 7 Ply Corrugated Box for packing Kit contents.</li> <li>2. Cleaning cloth (1 No.)</li> <li>3. Core cleaning solvent (1 Ampoule)</li> <li>4. Backup ring for Armour (Steel support ring) of suitable size.</li> <li>5. PVC Adhesive Tape</li> <li>6. Ferrule</li> <li>7. Heat shrinkable Insulating tubing for providing insulation over ferrule.</li> <li>8. Earthing shall be of material tinned Copper. The conductor/braid shall be supplied with suitable clamps.</li> <li>9. Galvanized steel wire mesh- To cover the 4 cores from armour to armour.</li> <li>10. Outer sleeve- The maximum length of outer sleeve shall be 500 mm for 25 sq.mm &amp; shall be 1000 mm for 300 sq.mm.</li> </ol>
4.2	Heat Shrinkable Components General properties	Components shall be capable of being stored without deterioration within temperature range of 10 Deg C to 45 Deg. C and shall have unlimited shelf life. Sealant activated by heat shall be used in conjunction with heat shrinkable components to provide an environmental seal to the completed joint.
4.3	Properties Of Heat Shrinkable Components	
	Property	Requirement
a	Electric Strength	>= 8 kV/mm
b	Heat shock 250 °C for 15 Min.	No splitting, dripping or flowing.
c	Tensile Strength	>= 12 Mpa ( 120 kg/sq.mm)
d	Elongation After Thermal Ageing at 120°C for 500Hrs.	>= 200%
e	Tensile Strength	>= 10 Mpa (100 kg/sq.mm)
f	Elongation	>= 100%
4.4	Insulation	The reinstated insulation of each core over conductor connector (Ferrule) shall have a single length of heat shrinkable tubing, recovered over the connector with a final minimum overlap of 30 mm on each core. The minimum recovered thickness of insulation shall be 1.5 mm.

**Technical Specification For Heat Shrinkable And Cold Shrinkable Straight Through Jointing Kit (1.1kV XLPE Insulated Cables)**

4.5	Armour Continuity	A flexible tinned copper conductor of braided construction shall provide electrical continuity of steel wire armour. The conductor shall be bonded to the armour wires by a combination of a galvanized steel ring inserted under the wires and stainless steel horse clips (steel grade SS 304). The arrangement shall ensure that temperature rise at bonding point is limited to 160 °C.
	Cable Size	Tinned Copper Conductor/strip/braid
a	25 sq.mm	16 sq.mm
b	50 sq.mm	30 sq.mm
c	120, 150,240 & 300 sq.mm	50 sq.mm
4.6	Mechanical Protection:	The joint shall incorporate a steel screen surrounding the insulated core for full length of the joint. The metallic screen shall be in electrical contact with steel wire armour, but shall not be considered as forming part of armour continuity bond. The steel screen in combination with external heat shrinkable tube shall provide protection to the insulated cores from damages by impacts.
4.7	Covering over the Joints:	The Joint shall be protected from corrosion by heat shrinkable tubes internally coated with mastic or heat activated sealant to provide an environmental seal to the joint. One or two tubes shall be provided.
4.8	Identification:	Heat shrinkable tubing shall be printed with batch no./Date/Shrinkage ratio/size etc.

**5.0.0 Polyurethane Compound**

4.1	Content	Resin & Hardener combination
4.2	Curing	On curing shall produce homogenous & void free mass Gel Time: 30 - 45 Minutes Solidify Time: 60 - 75 Minutes
4.3	Compound Properties	Colour & Appearance – Red / Brown filled liquid Viscosity at 25 ° C - 5000-15000 Cps Density - 1.52 ± 0.10 g/cc
4.4	Hardener Properties	Colour & Appearance - Dark Brown filled liquid Viscosity at 25 ° C - 180 ± 105 Cps. Density - 1.23 ± 0.05 g/cc

**Technical Specification For Heat Shrinkable And Cold Shrinkable Straight Through Jointing Kit (1.1kV XLPE Insulated Cables)**

4.5	Compound to Hardener ratio	100:16 ± 2 Parts by weight 100:19 ± 2 Parts by volume
4.6	Properties of Cured Compound	Tensile Strength - 50 Kg/cm <sup>2</sup> Min. Ultimate Elongation - 25 to 35 % Un-notched Impact Strength - > 25 Kg.cm/cm <sup>2</sup> Hardness - 85-90 Shore A Water Absorption - 0.5 % Max. Dielectric Strength - 10 KV/mm Minimum Volume Resistivity - 1014 Ohm.cm
4.7	Shelf Life	Minimum 1 Year Balance shelf life at the time of receipt of material at stores >= 9 months
4.8	Packing	In Air tight container
4.9	Quantity	As in Bill of Material ( BOM )
4.1	Marking	Type of System ( Resin or Hardener) Quantity in weight ( gms) & Volume ( cc) Batch Number Date of Packing Date of Expiry Manufacturer's Name

**6.0.0 Mould**

5.1	Material	High impact polystyrene (HIP)/ Polypropylene(PP)
5.2	Requirement	Shall be capable of sustaining the weight of the compound without deformation up to the maximum temperature developed during exothermic reaction. Shall be with pouring gates & risers.
5.3	Each half of the mould shall be embossed with-	Manufacturer's Name or Trademark Mould size(S3/S4/S5/S6) Year of manufacturing
5.4	Colour	White/ Transparent
5.5	Dimensions	As per the attached drawing

**7.0.0 Connector Insulation**

6.1	Material	EPR - Self Bonding Tape ( Min Thickness 0.75 mm)
6.2	Requirement	Shall be compatible with polyurethane compound. Shall not get affected during Gel time & hardening time which is an exothermic reaction. Mastic layer shall be covered with silicone release paper.

**Technical Specification For Heat Shrinkable And Cold Shrinkable Straight Through Jointing Kit (1.1kV XLPE Insulated Cables)**

6.3	Properties	Dielectric Strength- 15 KV/mm Minimum Continuous operating temperature-90 ° C Emergency operating temperature- 130 ° C for 4 hrs.
6.4	Dimensions	EPR - As per Bill of Material
6.5	Make	EPR - 3M Scotch 23, Scapa 2517, Bishop W963

**8.0.0 Aluminium Braid**

7.1	Purpose	Armour to Armour earthing continuity
7.2	Requirement	50% of braid shall be insulated with heat shrinkable cross-linked black tube to ensure the insulated earth at ferrule region. Thickness of the tube on full recovery to 8 mm shall be $2.5 \pm 0.2$ mm
7.3	Dimensions & Size	As per Bill of Material ( BOM)

**9.0.0 Aluminium Ferrule**

8.1	Requirement	Long barrel ferrule suitable for use in medium voltage distribution system. Corrosive inhibition paste (M/s Jainson or equivalent) inside the ferrule with plastic end caps.
8.2	Ferrule Type	S3 & S4 - Normal Dimensions S5 STRT- Phase Conductor -150 sqmm Neutral Conductor - 70 sqmm S5 TRJ- Phase Conductor -120-150 sqmm Neutral Conductor -70 sqmm S6 STRT- Phase Conductor -300 sqmm Neutral Conductor - 150 sqmm S5 TRJ- Phase Conductor -240-300 sqmm Neutral Conductor -120-150 sqmm Transition type ferrule shall have same outer diameter. Inner diameter shall be adjusted as per cable conductor size. Inner edge of ferrules should be chamfered for easy insertion of cable core.
8.3	Dimensions & Size	As per Bill of Material ( BOM)/ Drawing

**10.0.0 Inspection & Testing**

9.1	Type test	Type test on complete joint from CPRI / ERDA / NABL accredited labs as per IS 13573 -Part1. Randomly selected sample shall also be type tested without any commercial implication.
-----	-----------	--



**Technical Specification For Heat Shrinkable And Cold Shrinkable Straight Through Jointing Kit (1.1kV XLPE Insulated Cables)**

9.2	Acceptance test	As per IS 10333 1.0 Verification of BOM 2.0 Compound (Resin + Hardener)test:  Freshly mixed sample: 2.1.1 Gel time 2.1.2 Setting time  Cured compound: 2.2.1 Tensile strength 2.2.2 Ultimate elongation 2.2.3 Dielectric strength 2.2.4 Volume Resistivity 2.2.5 Water absorption 2.2.6 Hardness  3.0 Epoxy putty hardening time
9.3	Type test report validity	valid for last 5 years
9.4	Prototype Approval	Kit components & Bill of Material shall be approved by purchaser before proceeding to manufacturing
9.5	Inspection test witness by purchaser	On samples selected from lot
9.6	Inspection call to Purchaser	By 15 days in advance intimation
9.7	Acceptance test results submission	Along with inspection call
9.8	Guaranteed Life	Joint shall be guaranteed for a period of 5 years against defective design & material & shall be replaced free of cost to BSES if failed due to design / material defect.

**11.0.0 Container Printing**

10.1	Resin	Instructions for use: Pour all the contents of hardener bottle into the Compound tin. Mix the components for 3- 5 minutes & pour the mixed compound into the mold immediately thereafter. Wash hands with soap and water after the use. Caution: Destroy the empty tin after the use. Do not use it for storing any animal feed, water or food stuff.
------	-------	---

**Technical Specification For Heat Shrinkable And Cold Shrinkable Straight Through Jointing Kit (1.1kV XLPE Insulated Cables)**

10.2	Hardner	<p>Instructions for use: Pour all the contents of the bottle into the compound tin and continue as per the instructions provided on the resin container.</p> <p>Caution: Keep away from children. Do not breathe vapors. Avoid contact with skin &amp; eyes. Wear suitable protective clothing, safety goggles &amp; gloves. In case of contact with eyes rinse immediately at least for 15 minutes with plenty of water and seek medical attention immediately. After contact with skin, wash immediately with plenty of water and soap. Do not release the container to environment. Store away from heat or direct sun light. Keep the container tightly closed, away from oxidizing agents. This material and/ or its container must be disposed of as hazardous waste. Do not use the empty bottles for storing animal feed, water or food stuff.</p>
------	---------	--

**11.0 Packing and Delivery**

11.1	Packing	<p>In 7 Ply corrugated box made out of 150 GSM Virgin Kraft Paper. Protection against shocks &amp; vibration</p>
11.2	Packing identification labels	<p>Manufacturer Name, Number of items, Month &amp; Year of manufacturing, Shelf life of Kit, Property of BSES</p>
11.3	Corrugated Box contents	<p>Kit components in proper packing with label indicating component name, quantity &amp; shelf life. Bill of material sheet Instruction sheet for step by step jointing in English &amp; Hindi Mould shall be part of kit except S6</p>

**12.0 Deviations**

- a) Deviations from this specification shall be listed by bidder clause wise along with optional offer and has to submit the list along with bid./quotation. BSES will review the deviations and if BSES is agreed with the deviation, seller has to take written confirmation from BSES on deviation during tender evaluation..
- b) In the absence of any list of deviations from the Seller with bid as well as written confirmation from BSES on deviations, it will be assumed by the Buyer that the Seller complies with the Specification fully.
- c) Any deviations mentioned in any other submitted bid documents (i.e.in filled GTP, Catalog, BSES old approval, buyer's/seller's standards etc) by seller without separate deviation sheets will not consider as a deviation from this tech spec at any stage of contract.

**Technical Specification For Heat Shrinkable And Cold Shrinkable Straight Through Jointing Kit (1.1kV XLPE Insulated Cables)****13.0 Inspection Expenses**

Inspection ( i.e. routing test, acceptance test, type test, factory visit etc.) shall be done any time by BSES on the basis of PO or may involve 3<sup>rd</sup> party as per BSES requirement. Inspection expenses like accommodation, fooding, local transport, air fair, train fair, taxi (NCR) etc shall borne by seller.

Any kind of test (routine/type test/acceptance test if any) at 3<sup>rd</sup> lab (i.e. CPRI/ERDA/NABL approved lab ) shall be carried out by seller at their own cost. BSES may witness the test and the expenses like accommodation, fooding, local transport, air fair, train, taxi etc. shall borne by seller.

Above expenses shall be applied at each and every inspection and shall stand till closing of PO/WO/Rate contracts etc.

**14.0.0 Failure Analysis and Penalty**

Failure of joint shall be analyzed by BSES and Vendor jointly. Joint failure in regards to poor quality joint, poor work man ship, etc. shall be in the account of vendors. Losses due to failure shall be recovered from vendor in case of warranty.

**Annexure A - Bill of Material (BOM) for JNT KIT****Annexure A.1 - Bill of Material (BOM) for JNT KIT N-HS STRT 1.1KV 300MM2 MOULD S6**

S No.	Item Description	Function	Size / dimensions / rating (as applicable)	Qty/Kit
1	Mould	Insulation & environmental sealing	Refer Drawing	1Pair
2	Mould Holding Clip	To hold the mould	21 x 75mm (10 Nos)	2No
3	Epoxy Putty	Sealing of Mould	Resin - 200 gm Hardener - 200 gm Hardening time - 20+/- 5 Min.	1No
4	Compound	Mechanical protection to joint		
4.1.1	Resin		N Pack = 2.541 kg	6Nos
4.1.2	Resin		P Pack = 1.275 kg	1No
4.2.1	Hardener		N Pack = 0.421 kg	6Nos
4.2.2	Hardener		P Pack = 0.215 kg	1No
5	Worm drive clip	Tighten the braid	NO. 3 (SS 304) ( Refer Drawing)	2Nos

**Technical Specification For Heat Shrinkable And Cold Shrinkable Straight Through Jointing Kit (1.1kV XLPE Insulated Cables)**

6	G. i. Solid Collet	Support for the Armour	Dia. 55 ( Refer Drawing)	2Nos
7	Aluminum Braid 35 Sq.mm.	Earth connection	Length 900 mm	2Nos
8	Insulating Tube(Insulated on earthing braid)	Insulate the earth braid	Size 25/8, Length 450mm	2Nos
9	EPR Tape	Provide insulation on the Ferrule	600 mm ( W 38 mm)	8Nos
10	Ferrule	Joining of main conductor cores		
i)	Al. Crimping Ferrules 300mm <sup>2</sup>		Refer Drawing	3Nos
ii)	Al. Crimping Ferrules 150mm <sup>2</sup>		Refer Drawing	1No
11	Epoxy Cast Spacer	Separate the cores	Dia 75 ( Refer Drawing)	2Nos
12	PVC NA Tape	For binding of spacer	3/4" x 5mtrs	1No
13	Cleaning Liquid	Clean the cores	60ml	1No
14	Al oxide Paper ( P80)	Removal of burs on crimped ferrule	40 cm x 25 mm	1 No
15	Instruction Sheet	Installation method in English & Hindi		1No

\* Note: Expiry date of all the kit contents shall be 1 year only.

**Annexure A.2 - Bill of Material (BOM) for JNT KIT N-HS TRANSN 1.1KV 240/300 MLD S6**

S No.	Item Description	Function	Size / dimensions / rating (as applicable)	Qty/Kit
1	Mould	Insulation & environmental sealing	Refer Drawing	1Pair
2	Mould Holding Clip	To hold the mould	21 x 75mm (10 Nos)	2No
3	Epoxy Putty	Sealing of Mould	Resin - 200 gm Hardener - 200 gm Hardening time - 20+/- 5 Min.	1No
4	Compound	Mechanical protection to joint		
4.1.1	Resin		N Pack = 2.541 kg	6Nos
4.1.2	Resin		P Pack = 1.275 kg	1No
4.2.1	Hardener		N Pack = 0.421 kg	6Nos
4.2.2	Hardener		P Pack = 0.215 kg	1No
5	Worm drive clip	Tighten the braid	NO. 3 (SS 304) ( Refer Drawing)	2Nos
6	G. i. Solid Collet	Support for the Armour	Dia. 55 ( Refer Drawing)	2Nos

**Technical Specification For Heat Shrinkable And Cold Shrinkable Straight Through Jointing Kit (1.1kV XLPE Insulated Cables)**

7	Aluminum Braid 35 Sq.mm.	Earth connection	Length 900 mm	2Nos
8	Insulating Tube(Insulated on earthing braid)	Insulate the earth braid	Size 25/8, Length 450mm	2Nos
9	EPR Tape	Provide insulation on the Ferrule	600 mm ( W 38 mm)	8Nos
10	Ferrule	Joining of main conductor cores		
i)	Al. Crimping Ferrules 300mm <sup>2</sup>		Refer Drawing	3Nos
ii)	Al. Crimping Ferrules 150mm <sup>2</sup>		Refer Drawing	1No
11	Epoxy Cast Spacer	Separate the cores	Dia 75 ( Refer Drawing)	2Nos
12	PVC NA Tape	For binding of spacer	3/4" x 5mtrs	1No
13	Cleaning Liquid	Clean the cores	60ml	1No
14	Al oxide Paper ( P80)	Removal of burs on crimped ferrule	40 cm x 25 mm	1 No
15	Instruction Sheet	Installation method in English & Hindi		1No

\* Note: Expiry date of all the kit contents shall be 1 year only.

**Annexure A.3 - Bill of Material (BOM) for JNT KIT N-HS STRT 1.1KV 150MM2 MOULD S5**

S No.	Item Description	Function	Size / dimensions / rating (as applicable)	Qty/Kit
1	Mould	Insulation & environmental sealing	Refer Drawing	1Pair
2	Mould Holding Clip	To hold the mould	21 x 75mm (10 Nos)	2No
3	Epoxy Putty	Sealing of Mould	Resin - 200 gm Hardener - 200 gm Hardening time - 20+/-5 Min.	1No
4	Compound	Mechanical protection to joint		
4.1.1	Resin		N Pack = 2.541 kg	2Nos
4.2.1	Hardener		N Pack = 0.421 kg	2Nos
5	Worm drive clip	Tighten the braid	NO. 3 (SS 304) ( Refer Drawing)	2Nos
6	G. i. Solid Collet	Support for the Armour	Dia. 55 ( Refer Drawing)	2Nos
7	Aluminum Braid 25 Sq.mm.	Earth connection	Length 900 mm	2Nos

**Technical Specification For Heat Shrinkable And Cold Shrinkable Straight Through Jointing Kit (1.1kV XLPE Insulated Cables)**

8	Insulating Tube(Insulated on earthing braid)	Insulate the earth braid	Size 25/8, Length 450mm	2Nos
9	EPR Tape	Provide insulation on the Ferrule	600 mm ( W 38 mm)	8Nos
10	Ferrule	Joining of main conductor cores		
i)	Al. Crimping Ferrules 150mm <sup>2</sup>		Refer Drawing	3Nos
ii)	Al. Crimping Ferrules 70mm <sup>2</sup>		Refer Drawing	1No
11	Epoxy Cast Spacer	Separate the cores	Dia 75 ( Refer Drawing)	2Nos
12	PVC NA Tape	For binding of spacer	3/4" x 5mtrs	1No
13	Cleaning Liquid	Clean the cores	60ml	1No
14	Al oxide Paper ( P80)	Removal of burs on crimped ferrule	40 cm x 25 mm	1 No
15	Instruction Sheet	Installation method in English & Hindi		1No

\* Note: Expiry date of all the kit contents shall be 1 year only.

**Annexure A.4 - Bill of Material (BOM) for JNT KIT N-HS TRANSN 1.1KV 120/150 MLD S5**

S No.	Item Description	Function	Size / dimensions / rating (as applicable)	Qty/Kit
1	Mould	Insulation & environmental sealing	Refer Drawing	1Pair
2	Mould Holding Clip	To hold the mould	21 x 75mm (6 Nos)	2No
3	Epoxy Putty	Sealing of Mould	Resin - 200 gm Hardener - 200 gm Hardening time - 20+/-5 Min.	1No
4	Compound	Mechanical protection to joint		
4.1.1	Resin		N Pack = 2.541 kg	2Nos
4.2.1	Hardener		N Pack = 0.421 kg	2Nos
5	Worm drive clip	Tighten the braid	NO. 2 (SS 304) ( Refer Drawing)	2Nos
6	G. i. Solid Collet	Support for the Armour	Dia. 40 ( Refer Drawing)	2Nos
7	Aluminum Braid 25 Sq.mm.	Earth connection	Length 670 mm	2Nos
8	Insulating Tube(Insulated on	Insulate the earth braid	Size 25/8, Length 335mm	2Nos

**Technical Specification For Heat Shrinkable And Cold Shrinkable Straight Through Jointing Kit (1.1kV XLPE Insulated Cables)**

	earthing braid)			
9	EPR Tape	Provide insulation on the Ferrule	400 mm ( W 38 mm)	4Nos
10	Ferrule	Joining of main conductor cores		
i)	Al. Crimping Ferrules 120 - 150mm <sup>2</sup>		Refer Drawing	3Nos
ii)	Al. Crimping Ferrules 70mm <sup>2</sup>		Refer Drawing	1No
11	Epoxy Cast Spacer	Separate the cores	Dia 75 ( Refer Drawing)	2Nos
12	PVC NA Tape	For binding of spacer	3/4" x 5mtrs	1No
13	Cleaning Liquid	Clean the cores	60ml	1No
14	Al oxide Paper ( P80)	Removal of burs on crimped ferrule	40 cm x 25 mm	1 No
15	Instruction Sheet	Installation method in English & Hindi		1No

\* Note: Expiry date of all the kit contents shall be 1 year only.

**Annexure A.5 - Bill of Material (BOM) for JNT KIT N-HS STRT 1.1KV 50MM2 MOULD S4**

S No.	Item Description	Function	Size / dimensions / rating (as applicable)	Qty/Kit
1	Mould	Insulation & environmental sealing	Refer Drawing	1Pair
2	Mould Holding Clip	To hold the mould	21 x 75mm (6 Nos)	2No
3	Epoxy Putty	Sealing of Mould	Resin - 100 gm Hardener - 100 gm Hardening time - 20+/-5 Min.	1No
4	Compound	Mechanical protection to joint		
4.1.1	Resin		N Pack = 2.235 kg	2Nos
4.2.1	Hardener		N Pack = 0.375 kg	2Nos
5	Worm drive clip	Tighten the braid	NO. 1 (SS 304) ( Refer Drawing)	2Nos
6	G. i. Solid Collet	Support for the Armour	Dia. 26 ( Refer Drawing)	2Nos
7	Aluminum Braid 25 Sq.mm.	Earth connection	Length 630 mm	1Nos
8	Insulating Tube(Insulated on earthing braid)	Insulate the earth braid	Size 25/8, Length 315mm	1Nos
9	EPR Tape	Provide insulation on the Ferrule	250 mm ( W 38 mm)	8Nos

**Technical Specification For Heat Shrinkable And Cold Shrinkable Straight Through Jointing Kit (1.1kV XLPE Insulated Cables)**

10	Al. Crimping Ferrules 50mm <sup>2</sup>	Joining of main conductor cores	Refer Drawing	4Nos
11	Epoxy Cast Spacer	Separate the cores	Dia 50	2Nos
12	PVC NA Tape	For binding of spacer	3/4" x 5mtrs	1No
13	Cleaning Liquid	Clean the cores	Cleaning Tissue dipped in 6 ml Isopropyl Alcohol	3No
14	Al oxide Paper ( P80)	Removal of burs on crimped ferrule	40 cm x 25 mm	1 No
15	Instruction Sheet	Installation method in English & Hindi		1No

\* Note: Expiry date of all the kit contents shall be 1 year only.

**Annexure A.6 - Bill of Material (BOM) for JNT KIT N-HS STRT 1.1KV 25MM2 MOULD S3**

S No.	Item Description	Function	Size / dimensions / rating (as applicable)	Qty/Kit
1	Mould	Insulation & environmental sealing	Refer Drawing	1Pair
2	Mould Holding Clip	To hold the mould	21 x 75mm (10 Nos)	1No
3	Epoxy Putty	Sealing of Mould	Resin - 100 gm Hardener - 100 gm Hardening time - 20+/-5 Min.	1No
4	Compound	Mechanical protection to joint		
4.1.1	Resin		N Pack = 2.235 kg	1Nos
4.2.1	Hardener		N Pack = 0.375 kg	1Nos
5	Worm drive clip	Tighten the braid	NO. 1 (SS 304) ( Refer Drawing)	2Nos
6	G. i. Solid Collet	Support for the Armour	Dia. 22 ( Refer Drawing)	2Nos
7	Aluminum Braid 25 Sq.mm.	Earth connection	Length 420 mm	1Nos
8	Insulating Tube(Insulated on earthing braid)	Insulate the earth braid	Size 25/8, Length 210mm	1Nos
9	EPR Tape	Provide insulation on the Ferrule	400 mm ( W 19 mm)	8Nos
10	Al. Crimping Ferrules 25mm <sup>2</sup>	Joining of main conductor cores	Refer Drawing	4Nos
11	Epoxy Cast Spacer	Separate the cores	Dia 50	2Nos
12	PVC NA Tape	For binding of spacer	3/4" x 5mtrs	1No
13	Cleaning Liquid	Clean the cores	60ml	1No
14	Al oxide Paper ( P80)	Removal of burs on crimped ferrule	40 cm x 25 mm	1 No





SP-LTJKT-06R2

**Technical Specification For Heat Shrinkable And Cold Shrinkable Straight Through Jointing Kit (1.1kV XLPE Insulated Cables)**

15	Instruction Sheet	Installation method in English & Hindi	1No
----	-------------------	--	-----

\* Note: Expiry date of all the kit contents shall be 1 year only.



## Technical Specification For Heat Shrinkable And Cold Shrinkable Straight Through Jointing Kit (1.1kV XLPE Insulated Cables)

### Annexure C: Drawing of Al Crimping Ferrule

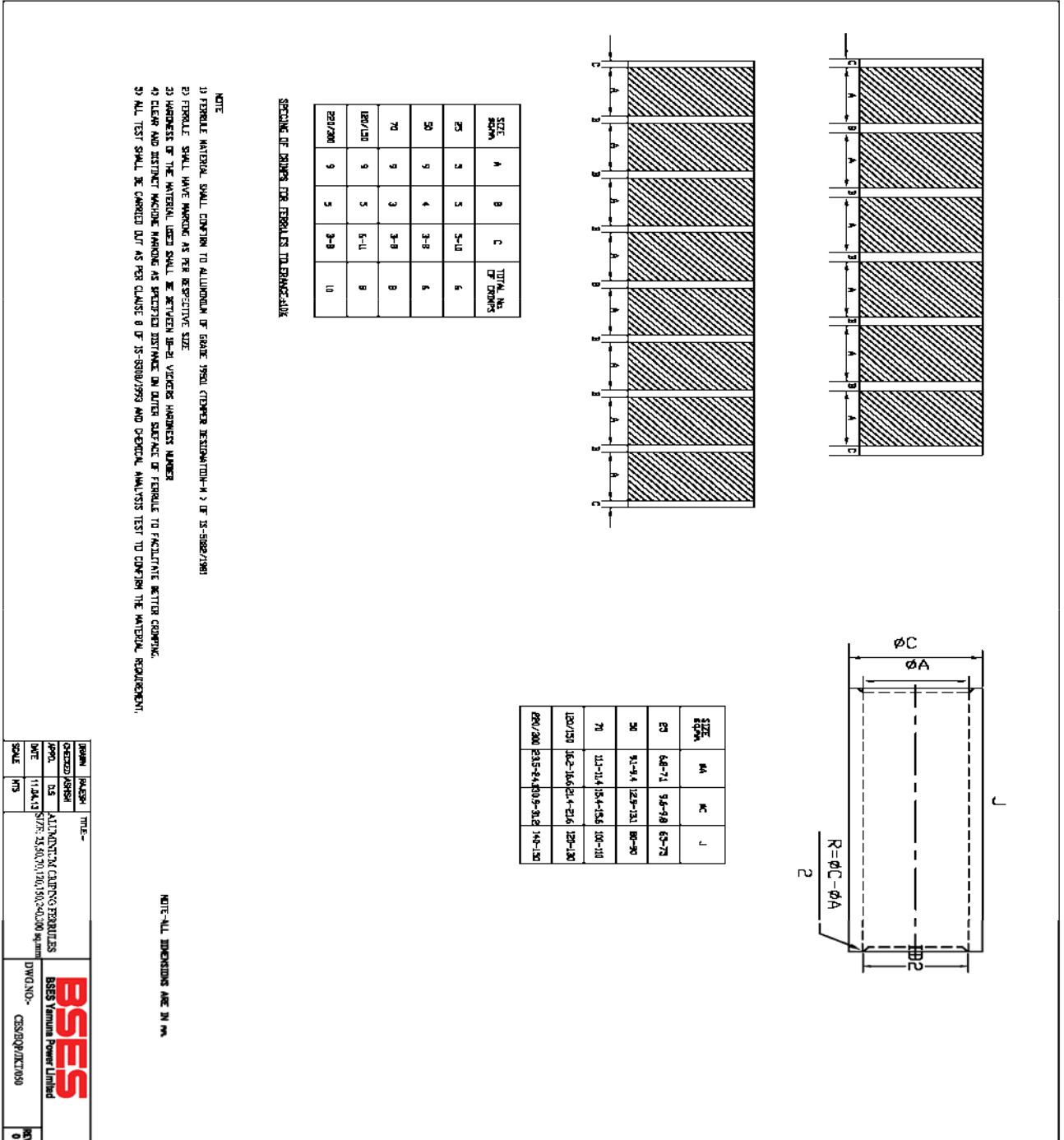

## Technical Specification For Heat Shrinkable And Cold Shrinkable Straight Through Jointing Kit (1.1kV XLPE Insulated Cables)

### Annexure D: Drawing of Worm Drive Clip

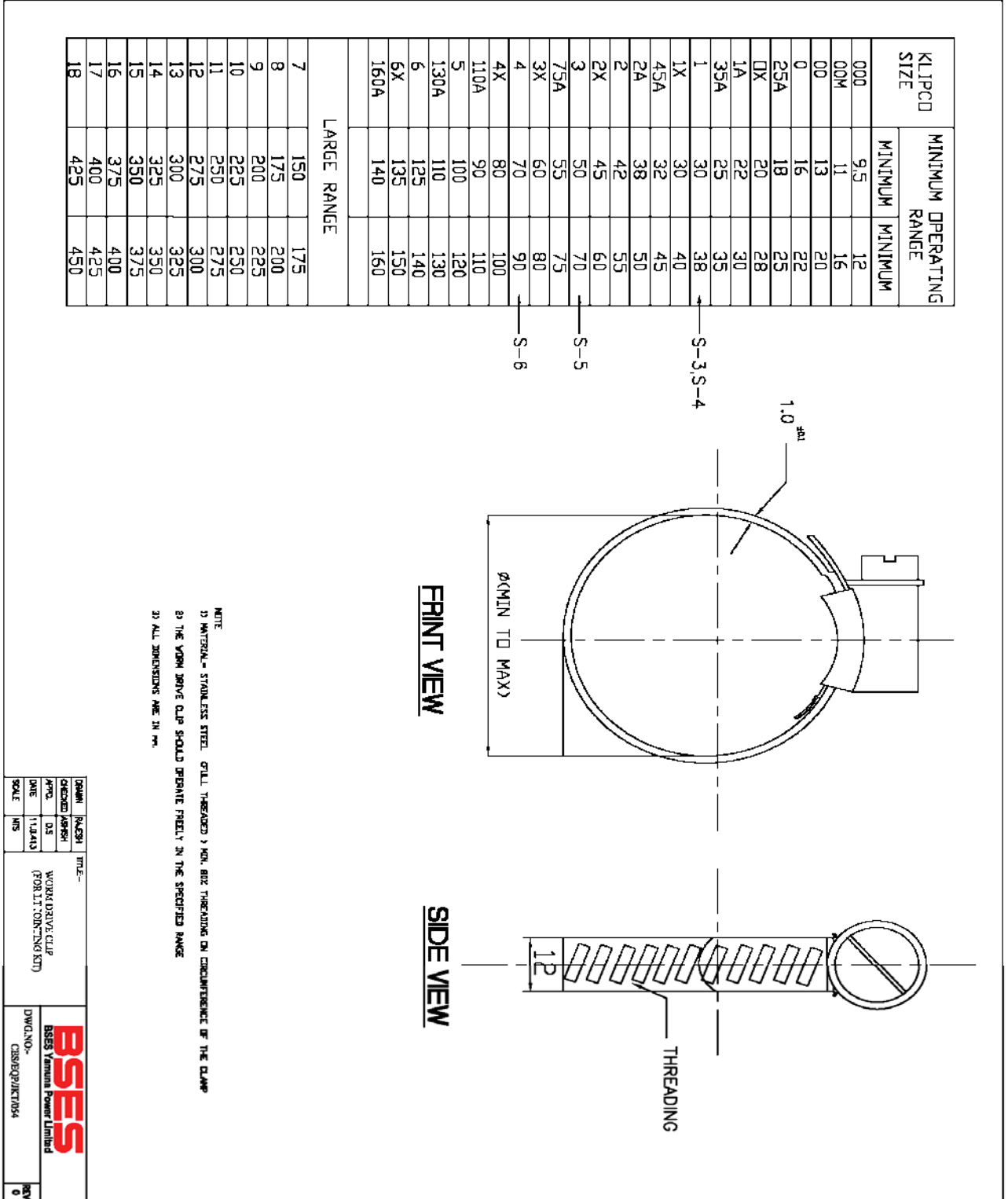

## Technical Specification For Heat Shrinkable And Cold Shrinkable Straight Through Jointing Kit (1.1kV XLPE Insulated Cables)

### Annexure E: Drawing of Solid Collet

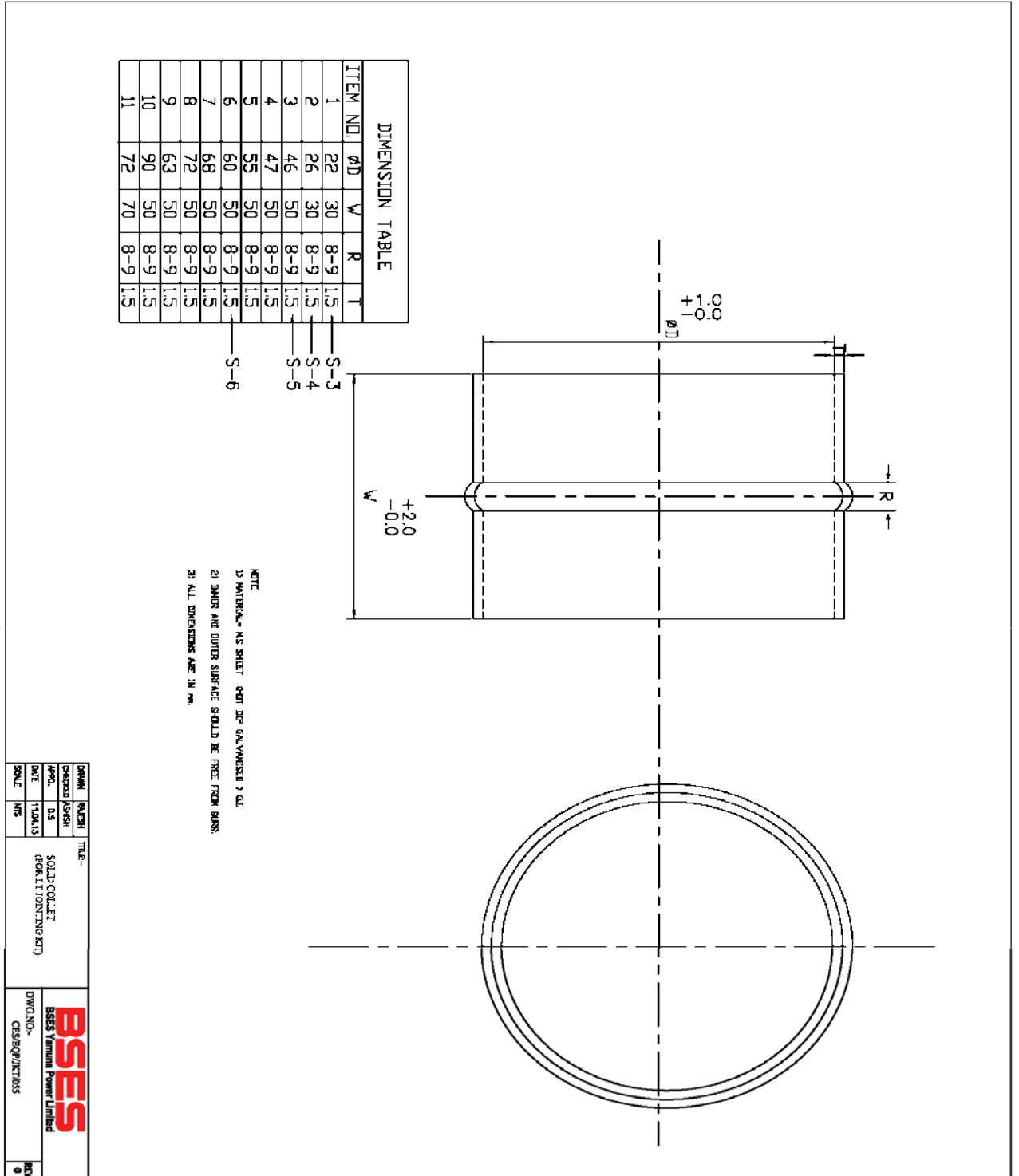

## Job Card For Cable Jointing Work

Job Card No  Date  Fault ID

Division  Purpose  Project / Scheme  O&M

Contractor

Voltage Grade  11kv  33kv  66kv  1.1 KV/LT

No. of cores  1  3  3.5/4

Cable Size: 1000 / 800 / 630 / 500 / 400 / 300 / 240 / 225 / 185 / 120 / 95 / 70 / 50/25 sqmm

Jointing Details	Type of Joints	No. of Joints		Docate No.	IR Ref.
		Single	Double		
	XLPE/XLPE(or PVC/PVC) Straight Through Joints				
	XLPE/PILCA Transition Joint				
	PILCA/PILCA Straight Through Joints				
	XLPE Indoor Termination				
	XLPE Outdoor Termination				
	PILC Indoor Termination				
	PILC Outdoor Termination				

Feeder Details From  To

Location From  To

Landmark: \_\_\_\_\_

Fault Occurance Date: \_\_\_\_\_

Job Allocated By: \_\_\_\_\_ PWT Ref: \_\_\_\_\_

Date and Time of Spiking   Work Completed On:

Digging Details (In Meter) Length  Wedth  Depth

Details of cable laid Size  Length (In Meter)  Docate Ref.:

Contractor Supervisor : \_\_\_\_\_ Signature : \_\_\_\_\_ Date : \_\_\_\_\_

Jointer Details: \_\_\_\_\_

Stage Verification	Stage/Work Verification	Name & Signature	Date & Time
ie : Digging / Jointing etc.			

Scrap Details including Qty: \_\_\_\_\_

New Kit Details: \_\_\_\_\_

Old Kit Details: \_\_\_\_\_

Type of Fault: \_\_\_\_\_

Remark If any : \_\_\_\_\_

Job Certified By :

Shift Incharge Name Signature Date

1\* COPY - BILLING COPY

## Annexure-G

<b>SOP FOR REPAIRING OF CABLE FAULT (Shall be part of PO)</b>		
Sl. No.	Activity	Responsibility
<b>Initiation</b>		
1	Identify and isolate fault and inform GNIIT in case of cable fault	Break down team
2	Updation of the details in OMS against respective feeder tripping event.	GNIIT
<b>Fault Location</b>		
1	Information sent to FLC team and SDO.	GNIIT
2	Mobilize FLC team and cable jointing contractor.	SDO
3	Identification of fault location	FLC Team
<b>Preparation for Jointing</b>		
1	Seeking permission from road owning agency	SDO
2	Payment of RR charges to Road owning agency	Finance
3	Digging	Cable jointing contractor
4	Cut faulty section and Pre-test (HV test) cable for multiple fault	Cable jointing contractor
5	BOQ estimation for jointing work ( type, size and length of cable, type of jointing kit)	Cable jointing contractor
6	Filling material reservation slip ( MRS) in SAP	SDO
7	Issuing and transporting material from store.	Cable jointing contractor
<b>Jointing</b>		
1	Cable preparation ( overlap length of cable, slide of armour, build up with inner sheath etc)	Cable jointing contractor (for jointing details refer to manufacturer instruction manual)
2	Copper tape shields	
3	Core preparation	
4	Location of parts in completed joints	
5	Earthing of connection	
6	Completion of joints	
7	Take Photographs before, during and after jointing and send to CES	SDO
8	Supervision during jointing	SDO
9	Sending failed joint to Division store	Cable jointing contractor
<b>Completion and reporting</b>		
1	Intimate to breakdown team about joint completion.	Cable jointing contractor
2	Conduct HV test	Break down team
3	Restore of Supply through jointed cable	Break down team
4	Backfilling and compaction of excavated soil	Cable jointing contractor
5	Completion information in Job Card (Details	Cable jointing contractor

Annexure-G

	of work done, material consumption, location, feeder name and joint tag no., date, supervisor name, jointer name) sent to SDO	
6	Above information sent to GNIIT	SDO
7	Send information about GPS location of Cable fault to GIS	SDO
8	daily report of cable jointing to CES	Division Head
9	Updation of information in OMS including supervisor name, jointer name, feeder name	GNIIT
10	Information to include GPS location of cable fault.	GNIIT

Special Note-

- 1) Joints to be done preferably during day. In case of constraints, DGM (O&M) to authorize for night time jointing with supervisor
- 2) Daily joint report to be shared with CES
- 3) Bi-monthly analysis of faulty joint for ensuring warranty compliance to be organized at circle level by contractor in presence of DGM (O&M) and CES
- 4) Certification of job card for payment by DGM (O&M) subject to OMS compliance CES to check any gaps.





**Technical Specification**  
**For Heat Shrinkable and GIS Cable Termination**  
**Kit (For 11 kV, 33 kV & 66 kV Cables)**

Specification no – SP-HSGTK-04-R3

Prepared by		Reviewed by		Approved by		Rev	Date
Name	Sign	Name	Sign	Name	Sign		
Pronab Bairagi		Amit Tomar	 26.04.17	Vijay Panpalia	 21/4/17	R3	26/04/2017

## Index

Record of Revision .....	3
1.0.0 Scope of work.....	4
2.0.0 Codes & standards .....	4
3.0.0 Cable Construction .....	5
4.0.0 Cable Termination Kits .....	6
5.0.0 Quality Assurance (QA).....	11
6.0.0 Deviations.....	11
7.0.0 Delivery .....	12
8.0.0 Inspection Expenses .....	12
9.0.0 Failure Analysis and Penalty .....	12
Annexure – A: Guaranteed Technical Particulars (GTP).....	12
Annexure – B: Kit Content Table (KCT) .....	14
Annexure – C: Routine and Acceptance Test.....	15
Annexure – D: Technical Deviation Sheet.....	16
Annexure – E: Service Conditions .....	16
Annexure – F: Bimetallic Aluminium / Copper Lug .....	17
Annexure – G: Aluminum Lug For XLPE Cable .....	18
Annexure – H: Job Card.....	19
Annexure – I: SOP .....	20

**Technical Specification For Heat Shrinkable And GIS Cable Termination Kit (11 KV, 33 KV, 66 KV Cables)****Record of Revision**

<b>Item/Clause No.</b>	<b>Change in Specification</b>	<b>Approved By</b>	<b>Rev</b>
3.14	HTAB Cable Jointing and Termination Kit		02
4.2.1e	GIS Termination kit-Plug in Type		01
4.2.1a	Hydraulic Crimping		02
4.5d	Type Test		02
Annexure-H	Job Card		02
Annexure-I	SOP		02
3.0.0	66kV , 3CX300 Cable Termination (Including OFC kit)		03
3.0.0	11kV , 3CX400 Cable Termination kit		03
4.2.1.(h)	Long barrel lugs		03
8.0.0	Inspection Expenses		03
9.0.0	Failure Analysis and Penalty		03

**Technical Specification For Heat Shrinkable And GIS Cable Termination Kit (11 KV, 33 KV, 66 KV Cables)****1.0.0 Scope of work**

Heat Shrinkable & GIS Termination Kits, suitable for 11 kV & 33 kV, 66KV XLPE / PILC cables, shall be designed, manufactured, tested, packed and delivered by the Vendor, as per Purchaser's requirements.

**2.0.0 Codes & standards**

## 2.1.0 National Standards:

SL	Standard Number	Title
2.1.1	IS - 13573: 2011	Joints & Terminations of Polymeric Cables for working voltages from 6.6 kV up to and including 33 kV Performance Requirements and Type Tests
2.1.2	IS – 7098 Part 2 : 1985	Cross-linked Polyethylene (XLPE) Insulated PVC sheathed cables : Part 2 : For working voltages from 3.3 kV up to and including 33 kV
2.1.3	IS - 692: 1994	Paper insulated lead-sheathed cables (PILC) for rated voltages up to and including 33 kV specification
2.1.3	IS - 10810: 1984	Methods of test for cables

## 2.1.1 International Standards:

S No.	Standard Number	Title
2.2.1	EA TS - 09 - 13	Electricity Association - Technical Specification -09-13 Material component for use in Electric Power Cable Termination & Joints for System voltage above 1000 V up to 36 kV
2.2.2	IEEE - 48	Standards Test Procedures and requirements for high voltage alternating current cable termination
2.2.3	IEC - 60183	Guide to the selection of high voltage cables
2.2.4	IEC - 885 Part 1-3	Electric test methods for electric cables
2.2.5	IEC - 60840	Power cable with extruded insulation and their accessories for rated voltage above 30 kV (Um=36 KV) up to 150 KV (Um=170 KV) - test methods and requirements.

**Technical Specification For Heat Shrinkable And GIS Cable Termination Kit (11 KV, 33 KV, 66 KV Cables)**

**3.0.0 Cable Construction**

Normal sizes of XLPE cables used in BSES system and the construction features of these cables are indicated below:

- 11kV, 3-core x 150 sq mm AL
- 11kV, 3-core x 300 sq mm AL
- 11kV, 3-core x 400 sq mm AL
- 11kV, 1-core x 1000 sq mm AL
- 11kV, 1-core x 1000 sq mm AL
- 11kV, 1-core x 150 sq mm AL HTAB
- 11kV, 1-core x 15 sq mm AL HTAB
- 33kV, 3-core x 300 / 400 sq mm AL
- 66kV, 1-core x 630 sq mm AL
- 66kV, 1 core x 1000 sq mm AL
- 66kV, 3-core x 300 sq mm AL

PILC type Cables:

3-core 240 or 300 sq. mm. Al

3.1.0	Conductor	<p>For XLPE :</p> <ul style="list-style-type: none"> <li>a) Electrolytic Grade stranded Aluminium Conductor / Annealed Copper Conductor</li> <li>b) Grade: H2/ H4 as per IS: 8130/84 (For Al)</li> <li>c) Shape: Compacted Circular</li> <li>d) Class 2</li> </ul> <p>For PILC :</p> <ul style="list-style-type: none"> <li>a) 11 kV : sector-shaped</li> <li>b) 33kV: oval-shaped</li> </ul>
3.2.0	Conductor Screen	<p>For XLPE :</p> <p>Extruded Semi Conducting material</p> <p>For PILC :</p> <p>11 kV : no conductor screen 33 kV : carbon paper</p>
3.3.0	Insulation	<p>For XLPE: Extruded XLPE up for 11 kV and TR XLPE for 33 kV, 66 kV and HTAB cable Insulation</p> <p>For PILC: Layers of impregnated papers</p>
3.4.0	Insulation Screen	<p>For XLPE :</p> <ul style="list-style-type: none"> <li>a) Freely strippable Semi Conducting ( without application of heat) for 66KV firmly bonded</li> <li>b) Copper Tape (Not applicable for HTAB)</li> </ul> <p>For PILC :</p> <ul style="list-style-type: none"> <li>a) 11 kV : absent (Belted)</li> <li>b) 33kV: metallised paper tape</li> </ul>

**Technical Specification For Heat Shrinkable And GIS Cable Termination Kit (11 KV, 33 KV, 66 KV Cables)**

3.5.0	Water Swellable Tape	For XLPE: Semi-conducting Water Swellable Tape shall be provided under the copper tape on each core. For PILC : not applicable
3.6.0	Filler	For XLPE: All interstices, including centre interstices filled by PP filler. Special Note- for 66kV 3CX300 sqmm cable only-36 nos. single mode and 12 nos. multi modes OFC are also inbuilt as filler. For PILC : a) 11 kV : Crushed paper filler b) 33kV: Jute twine
3.7.0	Over all three cores	XLPE : Binder tape PILCA : 11 kV : belt paper 33kV: Copper Woven Fabric tape
3.8.0	Inner Sheath	For XLPE: Extruded Inner Sheath of Black PVC type ST-2. For PILC : Lead alloy sheath
3.9.0	Bedding Tape	For XLPE: not applicable For PILC: two layers of paper, followed by compounded (bituminized) cotton tape.
3.10.0	Copper Woven Fabric Tape (CWF tape)	For XLPE : not applicable For PILC : a) 11 kV : absent (Belted cable) b) 33 kV : applicable for screened cable
3.11.0	Armour	For XLPE : a) Galvanised Steel round Wires/ Galvanised steel flat strip armour (For 3 core cables) b) Hard drawn Aluminium Wire (For 1 core cables) c) Aluminium or lead sheathed for 1Core 66KV cables For PILC : a) 11 kV double steel tape armour
3.12.0	Binder Tape	For XLPE: Rubberised cotton tape
3.13.0	Outer Sheath	For XLPE: Extruded outer sheath of PVC (ST-2) for 11 KV/ 33 KV and HDPE for 66KV Cable with termite- repellent. For 66Kv, 3CX300 Cable- HDPE extruded semicon layer or HDPE with graphite layer. For PILC : compounded (bituminised) Jute/PVC
3.14.0	HTAB Cable (1CX150 and 1CX95)	AB cable- conductor-conductor semicon screen- TR XPLE-insulation Water Swallowable tape -Round wire armour (in the place of copper tape) Water Swallowable tape-outer sheath+massengre wire

**4.0.0 Cable Termination Kits**

**Technical Specification For Heat Shrinkable And GIS Cable Termination Kit (11 KV, 33 KV, 66 KV Cables)**

General Technical Requirements for Cable Termination Kits are as follows:

4.1.0	Scope	Design, manufacture, testing and supply of Cable Termination Kits for H. T. Power Cables.
4.2.0	Functional Requirements	
4.2.1.	Conductor Connection	<p>a) Lug connection by crimping using hydraulic crimping tools, plug in type shall be for GIS. Using Hydraulic crimping tools is mandatory.</p> <p>b) Sizes of lugs are standardised as follows:            1. For 120 sq. mm. PILC cable and 150 sq. mm. XLPE cable, the lug suitable for 150 sq. mm. XLPE cable shall be used.            2. For 240 sq. mm. PILC cable and 300 sq. mm. XLPE cable, the lug suitable for 300 sq. mm. XLPE cable shall be used.            3. For 11Kv, 3CX400 lug shall be 400 sqmm.</p> <p>c) For aluminium cable, the lug shall be of aluminium</p> <p>d) Bi-metallic type lug having an aluminium barrel and a copper palm shall be considered for termination kit for RMU application. Refer Annexure E for details.</p> <p>e) For GIS cable termination kits: Plug in type, Conductor connection assembly shall be by standard method of split, silver-plated copper cone and pressure-fit contact assembly or as per manufacturer's standard.</p> <p>f) For 66KV 1cX1000 or 630mm<sup>2</sup> aluminium lugs shall be used.</p> <p>g) For 66Kv , 3CX300 lug shall be 300 sqmm.</p> <p>h) All the lugs shall be long barrel.</p>
4.2.2	Stress Control System	<p>a) The earthed insulation screen of an XLPE cable is terminated at a suitable distance from the conductor.</p> <p>b) The tube is in electrical contact with insulation screen.</p> <p>c) Impedance of the tube shall be constant up to an operating temperature and shall be within the range <math>1 \times 10^{08}</math> ohm-cm to <math>8 \times 10^{08}</math> ohm-cm.</p> <p>d) Length of stress control tube for 11 kV and 33 kV shall be 130 mm and 260 mm respectively.</p> <p>e) The physical and electrical properties shall conform to ESI 09: 13.</p> <p>f) For GIS cable termination kits Stress control shall be by means of a polymeric stress cone. External profile of the cone shall match inner profile of GIS epoxy bushing. Vendor shall specify the material (EPDM / Silicone) of the cone.</p>
4.2.3	Insulation Protection	<p>a) XLPE insulation shall be protected by means of an outer tube, resistant to tracking and weathering.</p> <p>b) One end of the tube shall be coated internally with red sealant mastic for a length of 50 mm.</p> <p>c) Physical and Electrical properties shall conform to ESI 09: 13.</p>

**Technical Specification For Heat Shrinkable And GIS Cable Termination Kit (11 KV, 33 KV, 66 KV Cables)**

4.2.3.1	Outer Anti-tracking Tube	Outer length of the tube shall be controlled by providing creepage Extension Shed having the same material composition as the tube. These lengths are given in the table below: Creepage distance shall be 31mm/kv minimum.
4.2.3.1	OFC (66Kv, 3CX300 sqmm cable)	Termination kit for OFC (36 single mode and 12 nos. multi mode )shall be supplied along with termination kit.

Cable System		Length of tube (mm)		Creepage Extension Shed (No.)	
Voltage	Cores	Indoor	Outdoor	Indoor	Outdoor
11 kV	3 - core	450 (650 for RMU)	650	Nil	2
	1 - core	340	340	NIL	2
33 kV	3 - core	800	1200	2	5
	1 - core	600	600	2	5

4.2.3.3	Oil Barrier Tube (applicable for PILC cable termination)	<p>a) Transparent tube is used for restoring the insulation provided by belt paper, which is terminated at the crotch.</p> <p>b) 33 kV PILC Termination: The oil barrier tube provides an oil-resistant layer to contain impregnating compound within, thus preventing anti-tracking tube coming in contact with the impregnating compound.</p>
4.2.4	Environmental Sealing System	<p>a) Red Sealant Mastic Tape: This tape, used for sealing at ends, shall be synthetic rubber-based and resistant to tracking and weathering. Sufficient quantity of this tape shall be provided.</p> <p>b) Lug-sealing Sleeve: It shall have the same material composition as outer anti-tracking tube. The sleeve shall be fully coated internally with red sealant mastic tape. Length of the sleeve shall be so as to cover half length of the lug barrel and an equal length of track-resistant tube.</p> <p>c) Conductive Break-out: It shall be provided over the crotch for 3-core cables. The break-out base shall overlap PVC outer sheath by a 50 mm. minimum.</p> <p>d) For GIS termination kits : Environmental sealing of cores below the switchgear shall be by means of a trifurcation kit, consisting of heat shrinkable conductive break-out and heat-shrinkable conductive tube of total length of 6 metres supplied in one roll.</p>



**Technical Specification For Heat Shrinkable And GIS Cable Termination Kit (11 KV, 33 KV, 66 KV Cables)**

4.2.5	Earth Bond System	<p>a) Earth Bond Assembly shall comprise of copper braided conductors as earthing conductors, GI armour support ring (non-split type) and two stainless steel hose clips.</p> <p>b) For GIS termination kit The earthing arrangement for 3-core cables shall be the same as stated under 'a' above.</p> <p>c) Two nos. copper braided conductors shall be of size: 25 sq. mm. for 11 kV cables, 35 sq. mm. for 33 kV cables and 50 sq. mm.</p> <p>d) Length of the copper braided conductor shall be 750 mm.</p> <p>e) Each copper braided conductor shall be supplied with copper lug, crimped at one end. Size of lug : 70 sq. mm. for 11 kV and 120 sq. mm. for 33 kV.</p>
4.2.6	Suppression of electrical discharges	<p>Following materials are required for use during cable termination :</p> <p>a) Silicone-based compound Required for filling-in minute services/ surface cracks over XLPE insulation.</p> <p>b) Polymeric mastic Required for application over semicon screen, for, eliminating any air-entrapment at any cut point on the surface. It should have sufficient elongation and electrical properties compatible with stress control tube.</p>
4.2.7	Installation. Instruction Sheet	It shall be in English and Hindi language and shall be provided inside every kit.
4.2.8	Paper Measuring Tap	Required for use during cable preparation / terminations.
4.3.0	Technical Particulars	Vendor shall submit Guaranteed Technical Particulars (GTP) as per Annexure A.
4.4.0	Type Tests	Termination Kit shall be of type-tested quality. In the absence of type test or in the case of type test is more than 5 years old, seller shall carry out the type test from CPRI/ERDA from BSES sample at their own cost. BSES may witness type test if required. All the cost of inspector shall be borne by seller as mentioned in inspection expenses clause. For new vendor, type test is mandatory from CPRI/ERDA of BSES sample at their own cost.
4.5.0	Testing & Inspection	
	a) Tests	All the routine and acceptance tests shall be carried out as per ESI guidelines. (Also refer Annexure -C)
	b) Inspection	<p>1) Buyer reserves the right to witness all tests specified on individual H. S. components, Moulded components or completed Cable Termination Kit.</p> <p>2) Buyer reserves the right to inspect Cable Termination Kit at the Seller's works at any time, prior to dispatch, to verify compliance with the specification.</p> <p>3) In-process and final inspection call intimation shall be given in advance to purchaser.</p>
	c) Test Certificates	Three sets of complete Test Certificates (Routine & Acceptance tests) shall be submitted along with the delivery of Cable Termination Kits.

**Technical Specification For Heat Shrinkable And GIS Cable Termination Kit (11 KV, 33 KV, 66 KV Cables)**

	d) Type Test	<p>a) Straight-Through Joint shall be of type-tested quality from CPRI/ERDA.</p> <p>b) In addition to this, in case of rate contact, vendor will be required to conduct type-testing on heat/cold -shrinkable and moulded components, stress grading mastic, etc., in line with EA TS 09-13 standard, at third party test laboratory once in 6 months on randomly selected sample of each voltage rating without any commercial implication to BSES. Also special test shall be done as per IS 13573.2.2011, Table-7 without any cost implication to BSES. Cable for type test may be provided by buyer at the cost of bidders.</p> <p>C) If product is not type tested or test report is more than 5 years old from CPRI/ERDA, same shall be carried out by seller, sample shall be selected randomly by BSES, test cost to be borne by seller. For new vendor, type test is mandatory from CPRI/ERDA of BSES sample at their own cost. All the cost of inspector shall be borne by seller as mentioned in inspection expenses clause</p>
4.6.0	Documents	"Documents" refer to Documents, Data, Manuals, etc. (Scanned copy of signed documents also shall be part of entire soft file (e-file) or CD.)
4.6.1	Along with the Bid	<p>Vendor shall submit signed 3 sets (plus 1 set of soft copy) of following documents:</p> <p>a) GTP (duly filled-in) (as per Annexure - A).</p> <p>b) Cross-sectional drawings for components Assembly</p> <p>c) Type Test Certificates</p> <p>d) Complete Catalogue and Instructions.</p> <p>e) Any other document.</p>
4.6.2	After Award of Contract	Vendor shall submit signed 2 sets (plus 1 set of soft copy) of above mentioned documents within 15 days, for Purchaser's approval.
4.6.3	"As-Built" documents	Final signed "As-built" documents for the equipment in 3 sets (hard copy), 1 no. soft copy and 1 no. CD. These documents shall include signed Routine & Acceptance Test Certificates also.
4.7.0	Packing, Marking, Shipping, Handling and Storage	Every component/kit/box shall be properly sealed/ packed for protection against damage.

**Technical Specification For Heat Shrinkable And GIS Cable Termination Kit (11 KV, 33 KV, 66 KV Cables)**

a)	Identification Labels:	<p>Markings / Labels shall be on both sides of every packed box.</p> <ol style="list-style-type: none"> <li>1) Identification number/type designation (as per manufacturer's standard)</li> <li>2) Voltage grade, size, description of the Kit (including the voltage grade, size, type of the cables, for which it is to be used)</li> <li>3) Batch no., lot no., etc.</li> <li>4) Quantity</li> <li>5) a) Purchase Order no. &amp; date b) Purchaser's name c) BSES's SAP code number</li> <li>6) Weight (kg) of each Cable Termination Kit and of each box containing kits.</li> <li>7) Manufacturer's name</li> <li>8) Month &amp; Year of Manufacturing</li> <li>9) Date of packing, Shelf life (if applicable)</li> <li>10) In case, the termination kit is for RMU, following text shall be written in bold letters, with higher font size : "For RMU Application".</li> </ol>
b)	Transit damage	The seller shall be responsible for any transit damage due to improper packing.

**5.0.0 Quality Assurance (QA)**

5.1.0	Vendor's Quality Plan (QP)	To be submitted for Purchaser's approval.
5.2.0	Sampling Method	Sampling Method for quality checks shall be as per manufacturer's standard practice / ESI guidelines and Purchaser's prior approval shall be taken for the same.
5.3.0	Inspection Hold-Points	To be mutually identified, agreed and approved in Quality Plan.

**6.0.0 Deviations**

6.1.0.	Deviations	<ol style="list-style-type: none"> <li>a) Deviations from this specification shall be listed by bidder clause wise along with optional offer and has to submit the list along with bid./quotation. BSES will review the deviations and if BSES is agreed with the deviation, seller has to take written confirmation from BSES on deviation during tender evaluation..</li> <li>b) In the absence of any list of deviations from the Seller with bid as well as written confirmation from BSES on deviations, it will be assumed by the Buyer that the Seller complies with the Specification fully.</li> <li>c) Any deviations mentioned in any other submitted bid documents (i.e.in filled GTP, Catalog, BSES old approval, buyer's/seller's standards etc) by seller without separate deviation sheets will not consider as a deviation from this tech spec at any stage of contract.</li> </ol>
--------	------------	--

**Technical Specification For Heat Shrinkable And GIS Cable Termination Kit (11 KV, 33 KV, 66 KV Cables)****7.0.0 Delivery**

7.1.0.	Delivery	Despatch of Material: Vendor shall despatch the material, only after the Routine Tests/Final Acceptance Tests (FAT) of the material witnessed/waived by the Purchaser, and after receiving written Material Despatch Clearance (MDC) from the Purchaser.
--------	----------	--

**8.0.0 Inspection Expenses**

Inspection ( i.e. routing test, acceptance test, type test, factory visit etc.) shall be done any time by BSES on the basis of PO or may involve 3<sup>rd</sup> party as per BSES requirement. Inspection expenses like accommodation, fooding, local transport, air fair, train fair, taxi (NCR) etc shall borne by seller.

Any kind of test (routine/type test/acceptance test if any) at 3<sup>rd</sup> lab (i.e. CPRI/ERDA/NABL approved lab ) shall be carried out by seller at their own cost. BSES may witness the test and the expenses like accommodation, fooding, local transport, air fair, train, taxi etc. shall borne by seller.

Above expenses shall be applied at each and every inspection and shall stand till closing of PO/WO/Rate contracts etc.

**9.0.0 Failure Analysis and Penalty**

Failure of joint shall be analyzed by BSES and Vendor jointly. Joint failure in regards to poor quality joint, poor work man ship, etc. shall be in the account of vendors. Losses due to failure shall be recovered from vendor in case of warranty.

**Annexure – A: Guaranteed Technical Particulars (GTP)**

The Seller is deemed to have examined all parts of the Specification documents and to have been fully informed, as to the nature of work and the conditions related to its performance.

S No.	Description	Purchase requirement	Vendor's data
1	Manufacturer's name		
2	Purchase Order no. & date		
3	Guarantee Period (minimum)	60 Months (from date of commissioning) / 66 Months (from date of receipt at Purchaser's store), whichever is earlier	
4	Applicable IS / IEC Standard followed by Vendor (incl. type test standard)		
5	Voltage Grade (kV)		

**Technical Specification For Heat Shrinkable And GIS Cable Termination Kit (11 KV, 33 KV, 66 KV Cables)**

5.1	Lightning Impulse Voltage Withstand Test		
5.2	4Uo AC voltage withstand test for 4 hours	To be conducted on Installed joint at works	
6	Continuous operating temperature	90 deg. C	
7	Functional Requirements		
7.1	Method of Stress Control and Discharge Suppression		
7.2	Method of Insulation build-up and screening		
7.3	Method of earth bond a) Size and no. of braids b) Size of armour support c) No. of hose clips		
7.4	Method of mechanical protection a) for 3-core Cable b) for 1-core Cable		
7.5	Method of protection against corrosion (type & coating thickness of protective layer on steel mat)		
7.6	Method of conductor continuity a) For crimping connector b) For mechanical connector		
8	Description of items in the Kit, which are imported /sourced From Principal /Sub-suppliers		
9	Names of items in the Kit and their respective shelf life (months   years)		
10	Kit Content Table (KCT) enclosed? (Refer Annexure — B)	Yes / No	
11	Drawing for connector (ferrule) enclosed	Yes / No (If yes, mention the document reference)	
12	Is Annexure - D (Technical Deviation Sheet) duly filled-in?		
13	Packing (Qty) i) Packing of every Kit h) Group Packing	1 no -- No. of Kits per Box -- No. of Boxes	

**Technical Specification For Heat Shrinkable And GIS Cable Termination Kit (11 KV, 33 KV, 66 KV Cables)**

14	Installation Procedure enclosed?	Yes / No (If yes, mention the document reference)	
15	Quality Assurance Plan (QAP for raw materials, in-process inspection, factory testing) is enclosed?	Yes / No	
16	Whether all heat-shrinkable and moulded components of the kit meet the requirements of and have been tested in accordance with EA TS -09-1 3.(for heat-shrinkable joints)	Yes / No (If yes, details of test report no. /Date /name of test laboratory to be mentioned.)	
17	Type Test Reports (TTR) (Relevant test report no. & date, With type, size, other details of each type of Kit.)  a) Prepared Joint:  CPRI TTR as per BIS / IEC enclosed?  b) Loose Components:  CPRI TTR as per EA TS 09-13 enclosed?	Yes/No      Yes/No	
18	Printing details on each of the Heat- shrinkable and Moulded components	(Mention the text, presently printed on each of the component)	
19	OFC kit (66KV, 3CX300 sqmm cable)	Yes/no	

**Annexure – B: Kit Content Table (KCT)**

Vendor shall submit KCT as a consolidated table, consisting of all data, such as:

**A. Heading**

1. Voltage grade, size, description of the Kit  
(Including the voltage grade, size, type of the cables, for which it is to be used)
2. Type designation (as per manufacturer's standard)

**B. Details / Parameters**

(For each component/item of the KCT)

**Technical Specification For Heat Shrinkable And GIS Cable Termination Kit (11 KV, 33 KV, 66 KV Cables)**

1. Lot no. /Batch no., etc.
2. Item number (manufacturer's standard)
3. Description
  - a) Material, type, make and grade
  - b) Dimensions cross sectional area
  - c) Colour,
  - d) Other description, if any
4. Function of the item
5. Quantity
6. Make/Name/Location of manufacturer/sub-vendor
7.
  - a) Minimum supplied (or in expanded form ) diameter
  - b) Maximum freely recovered diameter
8.
  - a) Minimum supplied (or in expanded form ) thickness
  - b) Maximum freely recovered thickness

**C. Notes on the KCT**

Markings, printings, other details for individual/group of components are to be mentioned on KCT. For example:

- a) Printing of item code, size, batch no., etc.
- b) Printing on components
- c) Other embossing or engraving, if any.

(Note: Vendor may attach an Annexure, for any additional information, if required.)

**Annexure – C: Routine and Acceptance Test****A. Visual Examination**

Condition of selected items / components, as per sampling method, shall be recorded. Some of the normal check-points can be as follows:

1. Every component shall be verified in quantity and description as per KCT.
2. All items shall be free from any defects, pin holes, cracks, etc.
3. Metallic components to be free from sharp edges.

**B. Measurements of Dimensions**

(Required / observed dimension — length, diameter, etc.)

1. Supplied dimensions
2. Recovered dimensions

**C. Destructive Testing**

On various heat-shrinkable / moulded components of ready Kits

**Technical Specification For Heat Shrinkable And GIS Cable Termination Kit (11 KV, 33 KV, 66 KV Cables)**

(Items 3 and 4 are applicable only for heat-shrinkable components)

1. Tensile Strength
2. Wall Thickness Ratio
3. Heat Shock
4. Longitudinal Change, after full recovery
5. Ultimate Elongation
6. Low Temperature Flexibility
7. Dielectric Strength
8. Volume Resistivity

**D. Routine Test Reports (RTR)**

(Typical)

Each RTR shall clearly indicate P.O. no. & date and also BSES's SAP code no. RTR shall record the serial numbers of the kits selected, as per vendor's sampling method. Following details, besides vendor's/manufacturers standard check-points, shall appear in every RTR.

**Annexure – D: Technical Deviation Sheet**

Sr No.	Clause No.	Deviation

**Annexure – E: Service Conditions**

(Atmospheric conditions at Site)

1	Delhi	
a)	Average grade Atmospheric Condition:	Heavily Polluted, Dry
b)	Maximum altitude above sea level	1000 M
c)	Ambient Air temperature	Highest 50 deg C, Average 40 deg C
d)	Minimum ambient air temperature	0 deg C
e)	Relative Humidity	90 % Max
f)	Thermal Resistivity of Soil	150 Deg. C cmm
g)	Seismic Zone	4
h)	Rainfall	750 mm concentrated in four months



**Technical Specification For Heat Shrinkable And GIS Cable Termination Kit (11 KV, 33 KV, 66 KV Cables)**

**Annexure – F: Bimetallic Aluminium / Copper Lug**

**LUG FOR  
240/300 sqmm CABLE**

**LUG FOR  
120/150 sqmm CABLE**

**CONDUCTIVE MATERIAL**

ALUMINIUM BARREL  
COPPER PLAM  
FULLY ANNEALED  
JOINING METHOD

ALUMINIUM BARREL  
COPPER PLAM  
FULLY ANNEALED  
JOINING METHOD

FINISH  
BRIGHT

- 1) ALL TEST SHALL BE CARRIED OUT AS PER ICE-G1238-1
- 2) BARRELS SHALL BE CAPED AND FILLED WITH GREASE SO AS TO AVOID OXIDATION OF THE ALUMINIUM
- 3) LUGS SHALL HAVE MARKING AS MAKE & SIZE ENDESSSED ON LUG.

SIZE sqmm	ALUMINIUM										COPPER									
	ØA	ØB	Ø	Ø	Ø	Ø	Ø	Ø	Ø	Ø	Ø	Ø	Ø	Ø	Ø	Ø	Ø	Ø	Ø	Ø
120/150	15.3	21.5	6.0	NA	8.3	2.3	1.7	3.0	1.0	7.3	3.0	11.0								
240/300	21.9	31.0	7.0	8.3	9.0	2.0	1.7	3.5	4.0	7.3	31.7	117.0								

FORM	MESH	TITLE
CHANGED	AS PER	BAROMETRIC
APPRO.	DATE	ALUMINIUM/COPPER LUG
SCALE	1/1	

NOTE- ALL DIMENSIONS ARE IN MM

**BSES**  
BSES Termination Power Limited  
DVG.NO-  
CES/SP/TK/1946

**Technical Specification For Heat Shrinkable And GIS Cable Termination Kit (11 KV, 33 KV, 66 KV Cables)**

**Annexure – G: Aluminum Lug For XLPE Cable**

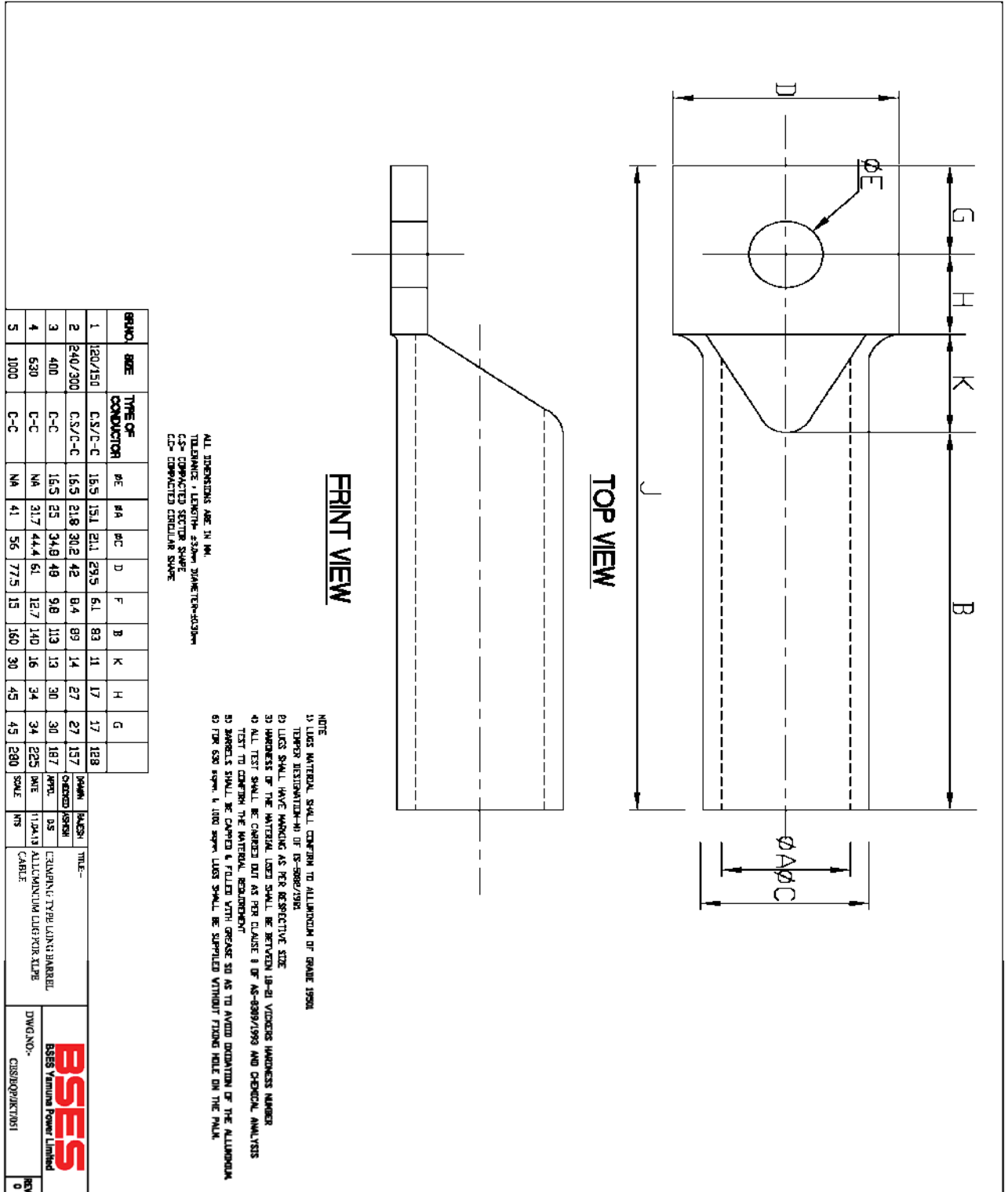

## Job Card For Cable Jointing Work

Job Card No  Date  Fault ID

Division  Purpose  Project / Scheme  O&M

Contractor

Voltage Grade  11kv  33kv  66kv  1.1 KV/LT

No. of cores  1  3  3.5/4

Cable Size: 1000 / 800 / 630 / 500 / 400 / 300 / 240 / 225 / 185 / 120 / 95 / 70 / 50/25 sqmm

Jointing Details	Type of Joints	No. of Joints		Docate No.	IR Ref.
		Single	Double		
	XLPE/XLPE(or PVC/PVC) Straight Through Joints				
	XLPE/PILCA Transition Joint				
	PILCA/PILCA Straight Through Joints				
	XLPE Indoor Termination				
	XLPE Outdoor Termination				
	PILC Indoor Termination				
	PILC Outdoor Termination				

Feeder Details From  To

Location From  To

Landmark: \_\_\_\_\_

Fault Occurance Date: \_\_\_\_\_

Job Allocated By: \_\_\_\_\_ PWT Ref: \_\_\_\_\_

Date and Time of Spiking   Work Completed On:

Digging Details (In Meter) Length  Wedth  Depth

Details of cable laid Size  Length (In Meter)  Docate Ref.:

Contractor Supervisor : \_\_\_\_\_ Signature : \_\_\_\_\_ Date : \_\_\_\_\_

Jointer Details: \_\_\_\_\_

Stage Verification	Stage/Work Verification	Name & Signature	Date & Time
ie : Digging / Jointing etc.			

Scrap Details including Qty: \_\_\_\_\_

New Kit Details: \_\_\_\_\_

Old Kit Details: \_\_\_\_\_

Type of Fault: \_\_\_\_\_

Remark If any : \_\_\_\_\_

Job Certified By :

Shift Incharge Name Signature Date

1\* COPY - BILLING COPY

## Annexure-I

<b>SOP FOR REPAIRING OF CABLE FAULT (Shall be part of PO)</b>		
Sl. No.	Activity	Responsibility
<b>Initiation</b>		
1	Identify and isolate fault and inform GNIIT in case of cable fault	Break down team
2	Updation of the details in OMS against respective feeder tripping event.	GNIIT
<b>Fault Location</b>		
1	Information sent to FLC team and SDO.	GNIIT
2	Mobilize FLC team and cable jointing contractor.	SDO
3	Identification of fault location	FLC Team
<b>Preparation for Jointing</b>		
1	Seeking permission from road owning agency	SDO
2	Payment of RR charges to Road owning agency	Finance
3	Digging	Cable jointing contractor
4	Cut faulty section and Pre-test (HV test) cable for multiple fault	Cable jointing contractor
5	BOQ estimation for jointing work ( type, size and length of cable, type of jointing kit)	Cable jointing contractor
6	Filling material reservation slip ( MRS) in SAP	SDO
7	Issuing and transporting material from store.	Cable jointing contractor
<b>Jointing</b>		
1	Cable preparation ( overlap length of cable, slide of armour, build up with inner sheath etc)	Cable jointing contractor (for jointing details refer to manufacturer instruction manual)
2	Copper tape shields	
3	Core preparation	
4	Location of parts in completed joints	
5	Earthing of connection	
6	Completion of joints	
7	Take Photographs before, during and after jointing and send to CES	SDO
8	Supervision during jointing	SDO
9	Sending failed joint to Division store	Cable jointing contractor
<b>Completion and reporting</b>		
1	Intimate to breakdown team about joint completion.	Cable jointing contractor
2	Conduct HV test	Break down team
3	Restore of Supply through jointed cable	Break down team
4	Backfilling and compaction of excavated soil	Cable jointing contractor
5	Completion information in Job Card (Details	Cable jointing contractor

Annexure-I

	of work done, material consumption, location, feeder name and joint tag no., date, supervisor name, jointer name) sent to SDO	
6	Above information sent to GNIIT	SDO
7	Send information about GPS location of Cable fault to GIS	SDO
8	daily report of cable jointing to CES	Division Head
9	Updation of information in OMS including supervisor name, jointer name, feeder name	GNIIT
10	Information to include GPS location of cable fault.	GNIIT



Special Note-

- 1) Joints to be done preferably during day. In case of constraints, DGM (O&M) to authorize for night time jointing with supervisor
- 2) Daily joint report to be shared with CES
- 3) Bi-monthly analysis of faulty joint for ensuring warranty compliance to be organized at circle level by contractor in presence of DGM (O&M) and CES
- 4) Certification of job card for payment by DGM (O&M) subject to OMS compliance CES to check any gaps.

# BSES

## Specification for 1.1kV LT Outdoor Termination Kit

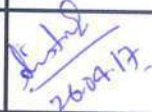
Specification no.: GN101-03-SP-52-01

Prepared by:		Approved by :		Approved by:		Rev	Dated
Name	Sign	Name	Sign	Name	Sign		
Pronab Bairagi		Amit Tomar	 26.04.17	Vijay Pampalia	 26/4/17	01	26.04.2017

## Index

<b>1.0.0 Scope of work.....</b>	<b>4</b>
<b>2.0.0 Codes &amp; standards.....</b>	<b>4</b>
<b>3.0.0 Cable Construction.....</b>	<b>5</b>
<b>4.0.0 Cable Termination Kits.....</b>	<b>5</b>
<b>5.0.0 Tests.....</b>	<b>8</b>
<b>6.0.0 Drawing, Data &amp; Manual.....</b>	<b>9</b>
<b>7.0.0 Quality Assurance (QA).....</b>	<b>10</b>
<b>8.0.0 Deviations.....</b>	<b>10</b>
<b>9.0.0 Inspection Expenses.....</b>	<b>10</b>
<b>10.0.0 Failure Analysis and Penalty.....</b>	<b>11</b>
<b>Annexure – A: Guaranteed Technical Particular (GTP).....</b>	<b>11</b>
<b>Annexure – B: Kit Content Table (KCT).....</b>	<b>14</b>
<b>Annexure – C: Routine and Acceptance Test.....</b>	<b>15</b>
<b>Annexure – D: Technical Deviation Sheet.....</b>	<b>15</b>
<b>Annexure – E: Service Conditions.....</b>	<b>16</b>
<b>Annexure – F: Aluminum Lug for XLPE Cable.....</b>	<b>17</b>
<b>Annexure – G: Job Card.....</b>	<b>18</b>
<b>Annexure – H: SOP.....</b>	<b>19</b>

**Records of Revision**

<b>Item/Clause No.</b>	<b>Change in Specification</b>	<b>Approved By</b>	<b>Rev</b>
<b>5.5.0</b>	<b>Type test</b>		<b>01</b>
<b>8.0.0</b>	<b>Deviation</b>		<b>01</b>
<b>9.0.0</b>	<b>Inspection Expenses</b>		<b>01</b>
<b>4.1.3 (A)</b>	<b>Hydraulic Crimping</b>		<b>01</b>
<b>Annexure-G</b>	Job Card		<b>01</b>
<b>Annexure-H</b>	SOP		<b>01</b>
<b>10.0.0</b>	<b>Failure Analysis and Penalty</b>		<b>01</b>



## 1.0.0 Scope of work

Heat Shrinkable Outdoor Termination Kits, suitable for 1.1 kV LT Power , XLPE Insulated, PVC sheathed cables shall be designed, manufactured, tested, packed and delivered by the Vendor, as per Purchaser's requirements.

## 2.0.0 Codes & standards

### 2.1.0 National Standards:

S. No.	Standard Number	Title
2.1.1	IS - 13573: 2011	Including Amendment part 1, Joints & Terminations, for Polymeric cables for working voltages 1.1 kV up to and including 3.3 kV - Type test requirements.
2.1.2	IS – 7098 Part 1 : 1988	Cross-linked Polyethylene (XLPE) Insulated PVC sheathed cables : Part 1 : For working voltages from up to and including 1.1 kV
2.1.3	IS - 10810: 1984	Methods of test for cables

### 2.2.0 International standards

S. No.	Standard Number	Title
2.2.1	EA TS - 09 - 13	Electricity Association - Technical Specification -09-13 Material component for use in Electric Power Cable Termination & Joints for System voltage above 1000 V up to 36 kV
2.2.2	IEC - 885 Part 1-3	Electric test methods for electric cables
2.2.3	IEC 60502-2009	Power cables with extruded Insulation and their accessories for rated voltages from 1kV up to 30kV.
2.2.4	ASTM D 2303	Standards Methods for Liquid, Inclined -Plane Tracking and Erosion of Insulation Material.
2.2.5	EN 50393	Specification, for 1.1 kV Cable joint & Terminations kit.

### 3.0.0 Cable Construction

Normal sizes of XLPE cables used in BSES system and the construction features of these cables are indicated below:

XLPE type Cables: **4-core x 150 or 300 sq.mm. Al**

3.1.0	Conductor	For XLPE : a) Electrolytic Grade stranded Aluminum Conductor b) Grade: H2/ H4 as per IS: 8130/84 (For Al) c) Shape: compacted sector shaped stranded d) Class 2
3.2.0	Insulation	For XLPE: Extruded XLPE Insulation
3.3.0	Inner Sheath	Extruded Inner Sheath of Black PVC type ST-2.
3.4.0	Armour	Galvanised steel flat strip armour
3.5.0	Outer Sheath	Extruded outer sheath of PVC (ST-2)

### 4.0.0 Cable Termination Kits

#### 4.1.0 General Construction:

The material shall be constructed in accordance with the applicable standards. The kits shall be suitable for storage without deterioration at temperatures up to 50 degrees C and shall have unlimited shelf life. The heat shrink system of the identical type brand as offered in the bids shall have proven performance of at least 5 years in Indian conditions. It should be supported by type test report and purchase orders of other utilities.

#### 4.1.1 Type of Termination:

Termination shall be heat shrinkable suitable for 1.1kV (E) four core XLPE Insulated and armoured cables (In line with BSES Specification & IS 7098-part1/1S 13573 (Part1)) having sector shaped stranded aluminium conductors of sizes 150 mm<sup>2</sup> & 300 mm<sup>2</sup>. Bidder shall furnish documentary evidence confirming adherence to these or the dimensions as per the type test report, whichever is higher. Fault level as well as duration withstands capacity of termination kits shall be matched with the parameters of cables (or which the kits are intended to be used for).

#### 4.1.2 Class of Terminations:

The heat shrinkable cable terminations are of Outdoor Termination suitable for pole top

mounting or on outdoor ACB terminal

#### **4.1.3 Heat shrinkable component- General Properties:**

Components shall be capable of being stored without deterioration upto a temperature of 50 Deg. C and shall have unlimited shelf life. Sealant activated by heat shall be used in conjunction with heat shrinkable components to provide on environmental to the completed termination.

##### **A) Aluminum Lug:**

Long barrel Aluminum Lugs with Anticorrosive/Antioxidation paste suitable for use in termination kits low voltage distribution system. Connectors (Lugs) used should be in line with IS 8337 and as **Annexure-F**.

All the lugs shall be crimped with hydraulic crimping tools during termination work. Using of Hydraulic crimping tool is mandatory.

##### **B) Tinned Copper Earthing Braid:**

A flexible tinned copper braid Insulated with Heat shrink tube shall provide electrical continuity of steel wire armour. The fault current capacity of copper braid should withstand the cable fault current capacity based upon different size of cable as defined in IS: 13234. The conductor shall be bonded to the armour wires by a combination of galvanized steel ring inserted under the wires and stainless steel horse clips (steel grade SS 304). The arrangement shall ensure that temperature rise at bonding points shall be limited to permissible temperature of cable.

Earthing braid should be provided with length sufficient to take one complete turn on armour and then continue to the other end of the armour with one turn around, This one turn will ensure the firm contact with the armour to tighten this braid worm drive clips two per side to be provided with back up ring the remaining 70 % of braid will be insulated with heat shrink tubes to ensure the Insulated earth at Heat shrink breakout region.

Braid terminal lug shall be suitable to accommodate M12 bolts for connection with earthing.

##### **C) Heat shrink Insulating tube:**

The minimum length of outer sleeve shall be . It shall also have UV rating to protect from direct sun light exposure.

Each Phase and neutral tube shall have different colour for easy identification. Preferably, Red, Yellow, Blue colour to be used for Phases and Black for neutral. If the same is not possible then at least, Red colour to be used for Phases and Black for neutral. Lug seal with HMA to be provided for lug sealing.

##### **D) Sub kit:**

The sub kit consists of Mopping cloth, PVC Tape, Core cleaning solvent, Black mastic tape Al2O3 Paper and other standard accessories essential for installation and satisfactory performance of the kit.

#### **4.2.0 Properties of Heat shrinkable components:**

Property	Requirement
Electric Strength	≥ 8 kV/mm
Heat shock at 250 deg C for 15 Min	No spilling, cracking, dripping or flowing
Tensile strength	≥12 Mpa ( 120 kg/sq.mm)
Elongation	≥ 200%
After Thermal Ageing at 120 deg C for 500Hrs.	
Tensile strength	≥10 Mpa ( 100 kg/sq.mm)
Elongation	≥ 100%

#### 4.3.0 General Kit contents of the Termination For 1.1Kv Cable:

BOM FOR 1.1 KV XLPE TERMINATION		
S.No.	Item	Quantity
1	Lugs/Connector with Anticorrosive/Antioxidation paste	4Nos
2.	Lug seal tube	4 nos
3.	Heat Shrink Core Protection Sleeves	4Nos
4	Earthing Set (with tinned copper braid)	1No
5.	Heat Shrink Breakout	1No
6.	Sub-kit (of Mopping cloth, PVC Tape, Core cleaning solvent, Black mastic tape and Al203 Paper etc)	1Set
7.	Installation Instruction manual with field quality plan	1No
8.	Packing Box	1No

## **5.0 TESTS**

All routine, acceptance & type tests shall be carried out accordance with the relevant IS/IEC. All routine & acceptance tests shall be witnessed by the purchaser/his authorized representative.

All the components shall also be type tested as per the relevant standards.

Following tests shall be necessarily conducted on the Termination kits in addition to others specified in IS/IEC standards

### **5.1.0 Type Tests**

- a) Impulse voltage withstand test
- b) Heat cycle test.
- c) A.C. withstand voltage test (Air and Water)
- d) Load cycle test
- e) Heat cycle test in water
- f) Insulation resistance test (Air and Water)

### **5.2.0 Routine Test:**

The bidder shall provide material wise routine test report conducted at their works during inspection.

### **5.3.0 Acceptance tests:**

- a) Visual Inspection- The offered kits shall be free from any visible defects,
- b) Physical verification of contents - all the contents shall be checked as per kit contents list enclosed by the bidder,
- c) Electric Strength test for Insulation tubing.
- d) Elongation tests for all types of tubing.
- e) Wall thickness ratio
- f) Longitudinal change after full recovery.
- g) Tracking and corrosion resistance test.
- h) Tensile strength.

### **5.4.0 TYPE TEST CERTIFICATES**

The bidder shall furnish the type test certificates for the tests mentioned above as per the corresponding standards. All the tests shall be conducted at CPRI/ERDA as per the relevant standards. Type tests should have been conducted from CPRI/ERDA during the period not before 5 years from the date of opening the bid. In the event of any discrepancy in the test reports, i.e. any test report not acceptable, same shall be carried out without any cost implication to the Purchaser.

### **5.5.0**

If product is not type tested or test report is more than 5 years old from CPRI/ERDA, same shall be carried out by seller, sample shall be selected randomly by BSES, test cost to be borne by seller. For new vendor, type test is mandatory from CPRI/ERDA of BSES sample at their own cost. All the cost of inspector shall be borne by seller as mentioned in inspection expenses clause

## 6.0.0 DRAWINGS, DATA & MANUALS

6.1.0	Documents	Copy of signed documents also shall be part of entire soft file (e-file) or CD.)
6.2.0	Along with the Bid	Vendor shall submit signed 3 sets (plus 1 set of soft copy) of following documents: a) GTP (duly filled-in) (as per Annexure - A). b) Cross-sectional drawings for components Assembly c) Type Test Certificates d) Complete Catalogue and Instructions. e) Manufacturing quality plan f) Field Quality Plan g) Lug dimension sheets. e) Any other document.
6.3.0	After Award of Contract	Vendor shall submit signed 2 sets (plus 1 set of soft copy) of above mentioned documents within 15 days, for Purchaser's approval.
6.4.0	"As-Built" documents	Final signed "As-built" documents for the equipment in 3 sets (hardcopy), 1 no. soft copy and 1 no. CD. These documents shall include signed Routine & Acceptance Test Certificates also.
6.5.0	Packing, Marking, Shipping, Handling and Storage	Every component/kit/box shall be properly sealed/ packed for protection against damage.
6.6.0	Identification Labels:	Markings / Labels shall be on both sides of every packed box. 1) Identification number/type designation (as per manufacturer's standard) 2) Voltage grade, size, description of the Kit (including the voltage grade, size, type of the cables, for which it is to be used) 3) Batch no., lot no., etc. 4) Quantity 5) a) Purchase Order no. & date b) Purchaser's name c) BSES's SAP code number 6) Weight (kg) of each Cable Termination Kit and of each box containing kits. 7) Manufacturer's name 8) Month & Year of Manufacturing 9) Date of packing, Shelf life (if applicable)
6.7.0	Transit damage	The seller shall be responsible for any transit damage due to improper packing.

**7.0.0 Quality Assurance (QA)**

7.1.0	Vendor's Quality Plan (QP)	To be submitted for Purchaser's approval.
7.2.0	Sampling Method	Sampling Method for quality checks shall be as per manufacturer's standard practice / ESI guidelines and Purchaser's prior approval shall be taken for the same.
7.3.0	Inspection Hold-Points	To be mutually identified, agreed and approved in Quality Plan.

**8.0.0 Deviations**

8.1.0.	Deviations	<p>a) Deviations from this specification shall be listed by bidder clause wise along with optional offer and has to submit the list along with bid./quotation. BSES will review the deviations and if BSES is agreed with the deviation, seller has to take written confirmation from BSES on deviation during tender evaluation..</p> <p>b) In the absence of any list of deviations from the Seller with bid as well as written confirmation from BSES on deviations, it will be assumed by the Buyer that the Seller complies with the Specification fully.</p> <p>c) Any deviations mentioned in any other submitted bid documents (i.e.in filled GTP, Catalog, BSES old approval, buyer's/seller's standards etc) by seller without separate deviation sheets will not be considered as a deviation from this tech spec at any stage of contract.</p>
--------	------------	--

**9.0.0 Inspection Expenses**

Inspection ( i.e. routing test, acceptance test, type test, factory visit etc.) shall be done any time by BSES on the basis of PO or may involve 3<sup>rd</sup> party as per BSES requirement. Inspection expenses like accommodation, fooding, local transport, air fair, train fair, taxi (NCR) etc shall be bore by seller.

Any kind of test (routine/type test/acceptance test if any) at 3<sup>rd</sup> lab (i.e. CPRI/ERDA/NABL approved lab ) shall be carried out by seller at their own cost. BSES may witness the test and the expenses like accommodation, fooding, local transport, air fair, train, taxi etc. shall be borne by seller.

Above expenses shall be applied at each and every inspection and shall stand till closing of PO/WO/Rate contracts etc.

**10.0.0 Failure Analysis and Penalty**

Failure of joint shall be analyzed by BSES and Vendor jointly. Joint failure in regards to poor quality joint, poor work man ship, etc. shall be in the account of vendors. Losses due to failure shall be recovered from vendor in case of warranty.

**Annexure – A: Guaranteed Technical Particulars (GTP)**

The Seller is deemed to have examined all parts of the Specification documents and to have been fully informed, as to the nature of work and the conditions related to its performance.

<b>S. No.</b>	<b>Description</b>	<b>Units</b>	<b>Vendor's data</b>
1	Manufacturer's name		
2	Purchase Order no. & date		
3	Guarantee Period (minimum)	60 Months (from date of commissioning) / 66 Months (from date of receipt at Purchaser's store), whichever is earlier	
4	Applicable IS /IEC Standard followed by Vendor (incl. type test standard)		
5	Voltage Grade	kV	
6	A.C. withstand voltage Dry (Ph./ground)	kV	
6.1	Time duration	Minutes	
7	A.C. withstand voltage wet (Ph./ground) immersed in water	kV	
7.1	Time duration	Minutes	
8	Impulse Withstand Voltages	kV	
9	Load Cycle Test		



	a) Each Cycle – Heating Duration Temperature Cooling Duration b) Number of Cycles	Hrs. Deg. C Hrs	
10	Heat Cycle test in water on outer sheath		
11.	Leak Tightness		
12.	Insulation Resistance in Air	500volt 50 Mega ohm	
13.	Insulation Resistance immersed in water	500volt 50 Mega ohm	
14.	Dielectric Strength of Insulating Material		
15.	DC Voltage Withstand test	kV/Min	
16.	Accelerated ageing test		
<b>17</b>	<b>KIT PARTICULARS</b>		
17.1	Material of the tubing /moulded parts		
17.2	Method of environmental seal		
17.3	Allowable Kit storage Temperature (50 deg. C)	Deg. C	
17.4	Shelf life of H.S. components	unlimited	
17.5	Cable Termination Installation Instructions manual	<b>Yes/No</b>	
17.6	Method of earth bond a) Size and no. of braids b) Size of armour support c) No. of hose clips		
17.7	Method of mechanical protection a) for 4-core Cable		

17.8	Method of protection against corrosion (type & coating thickness of protective layer on steel mat)		
17.9	Method of conductor continuity a) For crimping connector b) For mechanical connector	Hydraulic Crimping for Lugs	
18	Description of items in the Kit, which are imported /sourced From Principal /Sub-suppliers		
19	Names of items in the Kit and their respective shelf life (months/years)		
20	Kit Content Table (KCT) enclosed? (Refer Annexure - B)	Yes / No	
21	Drawing for Aluminum lugs with dimension(ferrule) enclosed	Yes / No (If yes, mention the document reference)	
22	Is Annexure - D (Technical Deviation Sheet) duly filled-in?		
23	Packing (Qty) i) Packing of every Kit h) Group Packing	1 no -- No. of Kits per Box -- No. of Boxes	
24	Installation Procedure enclosed?	Yes / No (If yes, mention the document reference)	
25	Quality Assurance Plan (QAP for raw materials, in-process inspection, factory testing) is enclosed?	Yes / No	
26	Whether all heat-shrinkable and moulded components of the kit meet the requirements of and have been tested in accordance with EA TS -09-1 3.(for heat-shrinkable joints)	Yes / No (If yes, details of test report no. /Date /name of test laboratory to be mentioned.)	
27	Type Test Reports (TTR) (Relevant test report no. & date, With type, size, other details of each type of Kit.)		

	a) Prepared termination CPRI/ERDA TTR as per BIS / IEC enclosed?	Yes/No	
	b) Loose Components: CPRI/ERDA TTR as per EA TS 09-13 enclosed?	Yes/No	
28	Printing details on each of the Heat- shrinkable and Moulded components	(Mention the text, presently Printed on each of the component)	

### Annexure – B: Kit Content Table (KCT)

Vendor shall submit KCT as a consolidated table, consisting of all data, such as:

#### A. Heading

1. Voltage grade, size, description of the Kit  
(Including the voltage grade, size, type of the cables, for which it is to be used)
2. Type designation (as per manufacturer’s standard)

#### B. Details / Parameters

(For each component/item of the KCT)

1. Lot no. /Batch no., etc.
2. Item number (manufacturer’s standard)
3. Description
  - a) Material, type, make and grade
  - b) Dimensions cross sectional area
  - c) Color,
  - d) Other description, if any
4. Function of the item
5. Quantity
6. Make/Name/Location of manufacturer/sub-vendor
7. a) Minimum supplied (or in expanded form ) diameter  
b) Maximum freely recovered diameter
8. a) Minimum supplied (or in expanded form ) thickness  
b) Maximum freely recovered thickness

#### C. Notes on the KCT

Markings, printings, other details for individual/group of components are to be mentioned on KCT. For example:

- a) Printing of item code, size, batch no., etc.
- b) Printing on components
- c) Other embossing or engraving, if any.

(Note: Vendor may attach an Annexure, for any additional information, if required.)

## Annexure – C: Routine and Acceptance Test

### A. Visual Examination

Condition of selected items / components, as per sampling method, shall be recorded. Some of the normal check-points can be as follows:

1. Every component shall be verified in quantity and description as per KCT.
2. All items shall be free from any defects, pin holes, cracks, etc.
3. Metallic components to be free from sharp edges.

### B. Measurements of Dimensions

(Required / observed dimension — length, diameter, etc.)

1. Supplied dimensions
2. Recovered dimensions

### C. Destructive Testing

On various heat-shrinkable /moulded components of ready Kits (Items 3 and 4 are applicable only for heat-shrinkable components)

1. Tensile Strength
2. Wall Thickness Ratio
3. Heat Shock
4. Longitudinal Change, after full recovery
5. Ultimate Elongation
6. Low Temperature Flexibility
7. Dielectric Strength
8. Volume Resistivity

### D. Routine Test Reports (RTR)

(Typical)

Each RTR shall clearly indicate P.O. no. & date and also BSES's SAP code no. RTR shall record the serial numbers of the kits selected, as per vendor's sampling method. Following details, besides vendor's/manufacturers standard check-points, shall appear in every RTR.

## Annexure – D: Technical Deviation Sheet

Sr No.	Clause No.	Deviation

**Annexure – E: Service Conditions**

(Atmospheric conditions at Site)

1	Delhi	
a)	Average grade Atmospheric Condition:	Heavily Polluted, Dry
b)	Maximum altitude above sea level	1000 M
c)	Ambient Air temperature	Highest 50 deg C, Average 40 deg C
d)	Minimum ambient air Temperature	0 deg C
e)	Relative Humidity	90 % Max
f)	Thermal Resistivity of Soil	150 Deg. C cmm
g)	Seismic Zone	4
h)	Rainfall	750 mm concentrated in four months

## Annexure – F: Aluminum Lug for XLPE Cable

Cable Size											
Cable details	Conductor shape	E	A	C	D	F	B	K	H	G	J
CABLE ARM XLPE 1.1KV 4C 300MM2 AL	SECTOR SHAPE	17	23.5	30.9	44.2	7	89	14	27	27	157
			-	-	-	-					
CABLE ARM XLPE 1.1KV 4C 150MM2 AL	SECTOR SHAPE	13	16.2	21.4	30.6	4.7	83	11	17	17	128
			-	-	-	-					
			16.6	21.6	31.2	5.3					

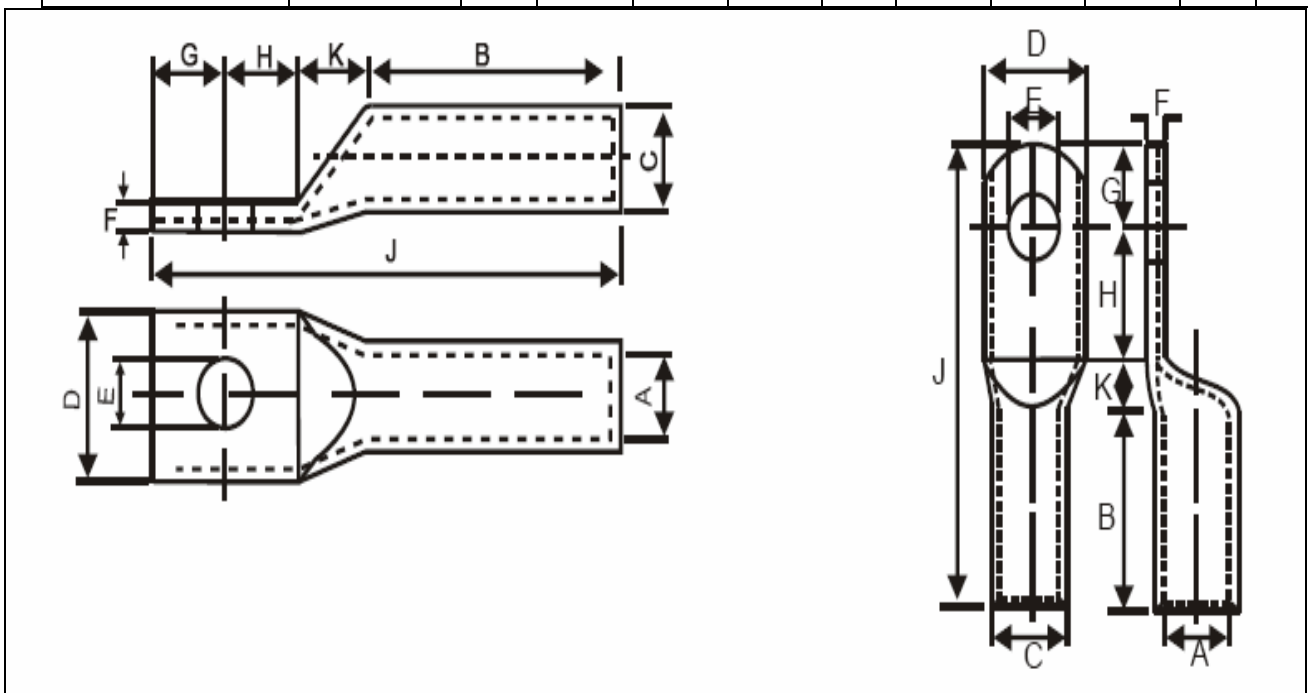

**NOTE: ALL DIMENSIONS ARE IN MM**



### Job Card For Cable Jointing Work

Job Card No  Date  Fault ID

Division  Purpose  Project / Scheme  O&M

Contractor

Voltage Grade  11kv  33kv  66kv  1.1 KV/LT

No. of cores  1  3  3.5/4

Cable Size: 1000 / 800 / 630 / 500 / 400 / 300 / 240 / 225 / 185 / 120 / 95 / 70 / 50/25 sqmm

Jointing Details	Type of Joints	No. of Joints		Docate No.	IR Ref.
		Single	Double		
	XLPE/XLPE(or PVC/PVC) Straight Through Joints				
	XLPE/PILCA Transition Joint				
	PILCA/PILCA Straight Through Joints				
	XLPE Indoor Termination				
	XLPE Outdoor Termination				
	PILC Indoor Termination				
	PILC Outdoor Termination				

Feeder Details From  To

Location From  To

Landmark: \_\_\_\_\_

Fault Occurance Date: \_\_\_\_\_

Job Allocated By: \_\_\_\_\_ PWT Ref: \_\_\_\_\_

Date and Time of Spiking   Work Completed On:

Digging Details (In Meter) Length  Wedth  Depth

Details of cable laid Size  Length (In Meter)  Docate Ref.:

Contractor Supervisor : \_\_\_\_\_ Signature : \_\_\_\_\_ Date : \_\_\_\_\_

Jointer Details: \_\_\_\_\_

Stage Verification	Stage/Work Verification	Name & Signature	Date & Time
ie : Digging / Jointing etc.			

Scrap Details including Qty: \_\_\_\_\_

New Kit Details: \_\_\_\_\_

Old Kit Details: \_\_\_\_\_

Type of Fault: \_\_\_\_\_

Remark If any : \_\_\_\_\_

Job Certified By :

Shift Incharge Name Signature Date

1\* COPY - BILLING COPY

## Annexure- H

<b>SOP FOR REPAIRING OF CABLE FAULT (Shall be part of PO)</b>		
Sl. No.	Activity	Responsibility
<b>Initiation</b>		
1	Identify and isolate fault and inform GNIIT in case of cable fault	Break down team
2	Updation of the details in OMS against respective feeder tripping event.	GNIIT
<b>Fault Location</b>		
1	Information sent to FLC team and SDO.	GNIIT
2	Mobilize FLC team and cable jointing contractor.	SDO
3	Identification of fault location	FLC Team
<b>Preparation for Jointing</b>		
1	Seeking permission from road owning agency	SDO
2	Payment of RR charges to Road owning agency	Finance
3	Digging	Cable jointing contractor
4	Cut faulty section and Pre-test (HV test) cable for multiple fault	Cable jointing contractor
5	BOQ estimation for jointing work ( type, size and length of cable, type of jointing kit)	Cable jointing contractor
6	Filling material reservation slip ( MRS) in SAP	SDO
7	Issuing and transporting material from store.	Cable jointing contractor
<b>Jointing</b>		
1	Cable preparation ( overlap length of cable, slide of armour, build up with inner sheath etc)	Cable jointing contractor (for jointing details refer to manufacturer instruction manual)
2	Copper tape shields	
3	Core preparation	
4	Location of parts in completed joints	
5	Earthing of connection	
6	Completion of joints	
7	Take Photographs before, during and after jointing and send to CES	SDO
8	Supervision during jointing	SDO
9	Sending failed joint to Division store	Cable jointing contractor
<b>Completion and reporting</b>		
1	Intimate to breakdown team about joint completion.	Cable jointing contractor
2	Conduct HV test	Break down team
3	Restore of Supply through jointed cable	Break down team
4	Backfilling and compaction of excavated soil	Cable jointing contractor
5	Completion information in Job Card (Details	Cable jointing contractor



Annexure-H

	of work done, material consumption, location, feeder name and joint tag no., date, supervisor name, jointer name) sent to SDO	
6	Above information sent to GNIIT	SDO
7	Send information about GPS location of Cable fault to GIS	SDO
8	daily report of cable jointing to CES	Division Head
9	Updation of information in OMS including supervisor name, jointer name, feeder name	GNIIT
10	Information to include GPS location of cable fault.	GNIIT

Special Note-

- 1) Joints to be done preferably during day. In case of constraints, DGM (O&M) to authorize for night time jointing with supervisor
- 2) Daily joint report to be shared with CES
- 3) Bi-monthly analysis of faulty joint for ensuring warranty compliance to be organized at circle level by contractor in presence of DGM (O&M) and CES
- 4) Certification of job card for payment by DGM (O&M) subject to OMS compliance CES to check any gaps.